



**sonia**<sup>®</sup>

**FURNITURE, MIRRORS & LIGHTS**  
**MUEBLES, ESPEJOS & LUCES**

 **UNIVERSE**



**EDITION / EDICIÓN**  
**2022 - 2023**

**CATALOGUE / PRICELIST**  
**CATÁLOGO / TARIFA**









## 40 YEARS LOOKING FORWARD

Being part of Arco Valves group provides Sonia 40 years of industrial know-how DNA.

From design, selection of raw materials, manufacturing, packaging, logistics, after sales service. At Sonia, every step is key.

And today more than ever our commitment with the environment and social context.

Sonia is about passion, effort and the goal of being better.

## 40 AÑOS MIRANDO AL FUTURO

Haber nacido dentro del grupo industrial Válvulas Arco, nos permite hablar de más de 40 años de experiencia.

El diseño, la selección de materiales, la fabricación, el transporte, el servicio post-venta... para Sonia cada paso es relevante.

Hoy, más que nunca, tenemos un sólido compromiso con la desigualdad social, el apoyo a la cultura y el respeto por el medio ambiente.

No dejamos de aprender. La historia de Sonia se basa en el esfuerzo, tratar siempre de alcanzar la excelencia, conseguir el éxito y proporcionar la mejor respuesta al mercado.

# HISTORY | 40 YEARS INDUSTRIAL EXCELLENCE BACKGROUND



**1980**

Ford Fiesta inside door handle.

Ford Fiesta maneta de la puerta interior.

**1989**

We are recipients of Ford's Q1 Certification.

Obtenemos la certificación Q1 de Ford.

**90's**

German leading brands such as Hansa, Hansgrohe, Grohe, and Dornbracht rely on our processes to produce some of their products.

Marcas líderes alemanas, como Hansa, Hansgrohe, Grohe y Dornbracht confían en nosotros para producir algunos de sus productos.



**2007**

E-Plus:  
Simplicity and contract collection.

E-Plus:  
Simplicidad y colección contract.

**2013**

S-Cube:  
Expanding finish options.

S-Cube:  
Ampliando la gama de acabados.

**2015**

S8 24K:  
High end luxury collection.

S8 24K:  
Colección lujosa de gama alta.



**1991**

Bola and Norda: The first two Sonia Collections.

Bola y Norda: Las dos primeras colecciones de Sonia.



**1995**

Our client data base increased with names like: Volvo, Jaguar, Volkswagen Valeo.

Nuestros clientes crecen con nombres como: Volvo, Jaguar, Volkswagen, Valeo.



**2005**

After developing 20 accessory collections, we expand our product range to vanities, washbasins, mirrors and lighting.

Después de 20 colecciones de accesorios, extendemos nuestra gama de productos a muebles, lavabos, espejos e iluminación.



**2017**

Luce: Functionality two high end materials with outstanding finishes.

Luce: Funcionalidad con dos materiales de alta gama con acabados excepcionales.



**2019**

Époque: Natural oak wood craftsmanship.

Époque: Artesanía en madera de roble natural.



**2021**

Quick: New functionalities.

Quick: Nuevas funcionalidades.

# FURNITURE

---





# FURNITURE MUEBLE

		EVOLVE	ÉPOQUE	MITTE	PLAY	CODE	PUZZLE
<b>FINISHES ACABADOS</b>	LACQUERED LACADOS	2	3	2	2	1	2
	MELAMINE MELAMINAS	2	-	3	2	3	-
	WOOD MADERA	-	3	-	-	-	-
<b>MODULAR MODULAR</b>		YES	NO	NO	NO	NO	NO
<b>THICKNESS ESPESOR</b>		19 mm	19 mm	19 mm	19 mm	19 mm	19 mm
<b>HARDWARE</b>		YES	YES	YES	YES	YES	YES
<b>HANDLES TIRADORES</b>	TYPES MODELOS	3	1	-	1	-	-
	FINISHES ACABADOS	4	5	-	5	-	-
<b>TYPES OF BASINS TIPOS DE LAVABOS</b>	BASINS LAVABOS	YES	YES	YES	YES	YES	YES
	COUNTER ENCIMERAS	YES	NO	YES	NO	NO	YES
<b>ACCESSORIES ACCESORIOS</b>		NO	NO	YES	NO	NO	NO
<b>SIZES TAMAÑOS</b>	<100	60   80	60   80	80	80	60   80	50
	>100	100   120   140	100	100	100	100   120	-
<b>MOISTURE RESISTANT RESISTENTE A LA HUMEDAD</b>		YES	YES	YES	YES	YES	YES
<b>PRICE PRECIO</b>		€€€	€€€	€€€	€	€€	€

EVOLVE

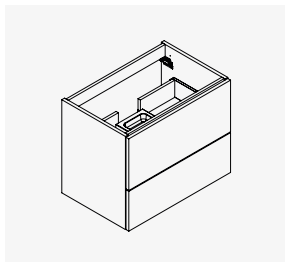

ÉPOQUE



MITTE

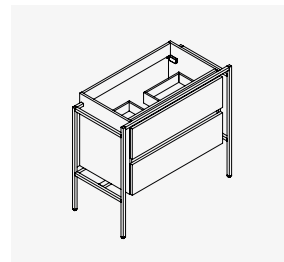

PUZZLE

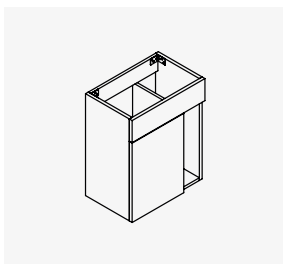

PLAY

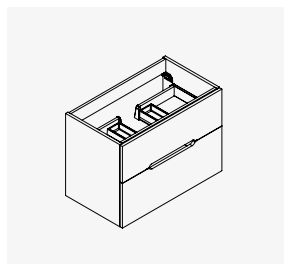

CODE

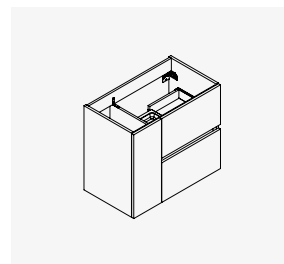

# BASINS

---



# BASINS LAVABOS

	MX1	MX3	MX4	MX8		MX10		SX7	SX12
	MINERAL MARMO		MINERAL COMPOSITE		MINERAL		CERAMIC		
	GLOSS BRILLO	MATT MATE	GLOSS BRILLO	MATT MATE	GLOSS BRILLO	MATT MATE	WHITE BLANCO	COLORS COLORES	
<b>IMPACT RESISTANCE</b> RESISTENCIA A LOS IMPACTOS	MEDIUM	MEDIUM	HIGH	HIGH	MEDIUM	MEDIUM	LOW	LOW	
<b>SCRATCH RESISTANCE</b> RESISTENCIA RASGUÑOS	LOW	MEDIUM	LOW	MEDIUM	LOW	MEDIUM	HIGH	LOW	
<b>CHEMICALS RESISTANCE</b> RESISTENCIA A QUÍMICOS	MEDIUM	MEDIUM	MEDIUM	MEDIUM	MEDIUM	MEDIUM	HIGH	MEDIUM	
<b>REPAIRABLE</b> REPARABLE	YES	YES	YES	YES	YES	YES	NO	NO	
<b>HOLE DRILLING</b> PERFORACIÓN	YES	YES	YES	YES	YES	YES	NO	NO	
<b>MINIMUM RADII (MM)</b> RADIOS MÍNIMOS	2	2	2	2	2	2	5 - 10	5 - 10	
<b>GLOSS INTENSITY</b> INTENSIDAD BRILLO	HIGH	N/A	HIGH	N/A	MEDIUM	N/A	HIGH	HIGH	
<b>MATT INTENSITY</b> INTENSIDAD MATE	N/A	HIGH	N/A	HIGH	N/A	HIGH	LOW	LOW	
<b>ABRASIVE CLEANING</b> LIMPIEZA ABRASIVA	NO	OK	NO	OK	NO	OK	OK	NO	

MX1

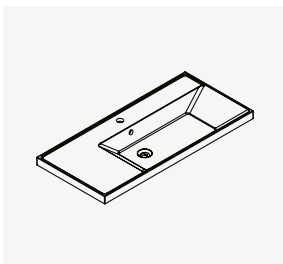

MX3

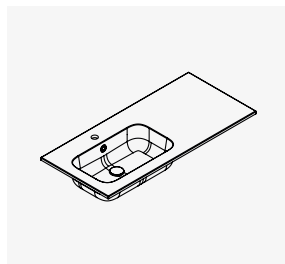

MX4

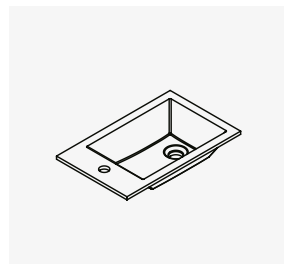

MX8

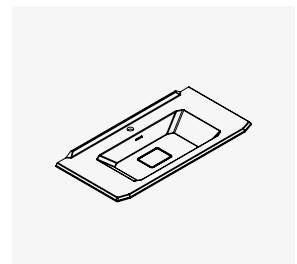

MX10

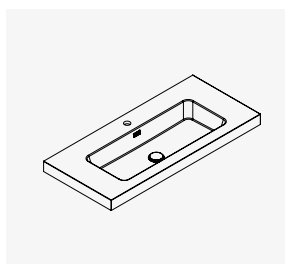

SX7

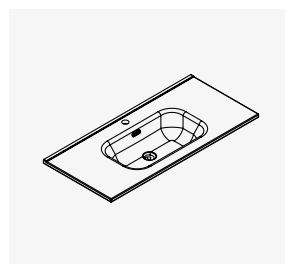

SX12

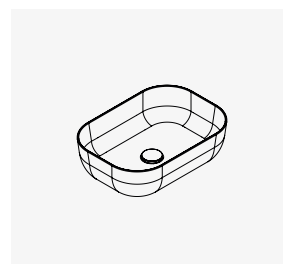

# MINERAL MARMO SOLID

MX1 | MX3 | MX4

## MX1



### SPECS ESPECIFICACIONES

- Material: Mineral Marmo® (White Gloss).  
Material: Mineral Marmo® (Blanco Brillo).
- Composition: 75% natural minerals (calcium carbonate and aluminum trihydrates), 25% polyester resin.  
Composición: 75% minerales naturales (carbonato de calcio y trihidratos de aluminio), 25% resina de poliéster.
- Standard: 1 faucet hole.  
Optional: 3 faucet hole.  
Standard: 1 taladro.  
Opcional: 3 taladros.
- Overflow: integrated.  
Rebosadero integrado.
- Injection modeling.  
Modelado por inyección.
- Drain 1 1/4".  
Desagüe 1 1/4".

### CABINET MATCH COMPATIBILIDAD

- Play.
- Code.

### DIMENSIONS MEDIDAS

60

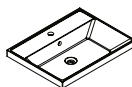

80

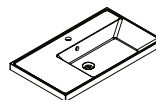

100

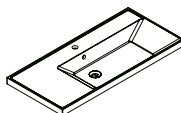

120

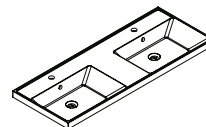

### FINISHES ACABADOS

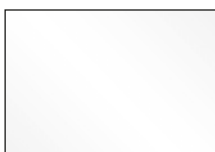

MINERAL MARMO  
GLOSS WHITE  
BLANCO BRILLO

# MX3



## SPECS ESPECIFICACIONES

- Material: Mineral Solid® (White Matt).  
Material: Mineral Solid® (Blanco Mate).
- Composition: 75% natural minerals (calcium carbonate and aluminum trihydrates), 25% polyester resin.  
Composición: 75% minerales naturales (carbonato de calcio y trihidratos de aluminio), 25% resina de poliéster.
- Standard: 1 faucet hole.  
Optional: 0 or 3 faucet hole.  
Standard: 1 taladro.  
Opcional: 0 o 3 taladros.
- Overflow: integrated.  
Rebosadero integrado.
- Injection modeling.  
Modelado por inyección.
- Drain 1 1/4".  
Desagüe 1 1/4".

## CABINET MATCH COMPATIBILIDAD

- Play.
- Evolve.

## DIMENSIONS MEDIDAS

60  
Centered  
Centrado

80  
Centered  
Offset Edge Right / Left  
Centrado  
Deplazado izq. / dcha.

100  
Centered  
Offset Edge Right / Left  
Centrado  
Deplazado izq. / dcha.

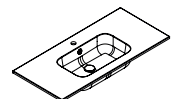
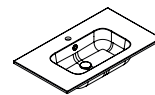

120  
Double  
Offset Edge Right / Left  
Doble  
Deplazado izq. / dcha.

140  
Double  
Doble

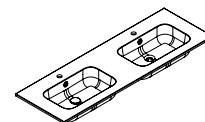
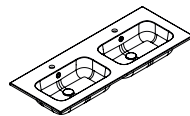

## FINISHES ACABADOS



MINERAL SOLID  
MATT WHITE  
BLANCO MATE



# MINERAL MARMO SOLID

MX1 | MX3 | MX4

## MX4



### SPECS ESPECIFICACIONES

---

- Material: Mineral Solid® (Matt White).  
Material: Mineral Solid® (Blanco Mate).
- Composition: 75% natural minerals (calcium carbonate and aluminum trihydrates), 25% polyester resin.  
Composición: 75% minerales naturales (carbonato de calcio y trihidratos de aluminio), 25% resina de poliéster.
- Standard: 1 faucet hole.  
Optional\*: without faucet hole.  
Standard: 1 taladro.  
Opcional\*: sin taladro.
- Overflow: without.  
Sin rebosadero.
- Drain 1 1/4".  
Desagüe 1 1/4".

### CABINET MATCH COMPATIBILIDAD

---

- Puzzle.

### DIMENSIONS MEDIDAS

---

50

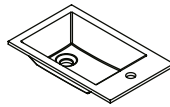

### FINISHES ACABADOS

---



MINERAL SOLID  
MATT WHITE  
BLANCO MATE

\*Consult conditions.  
\*Consultar condiciones.

# MINERAL COMPOSITE

MX8

## MX8



### SPECS ESPECIFICACIONES

- Material: Mineral Rock composite ground with dolomite. Coated with nanolayer of quartz resin.  
Material: Piedra Mineral compuesta con piedra dolomita. Recubierto con nanocapa de resina de cuarzo.
- Composition: 75% ground rock mineral, 25% resin.  
Composición: 75% mineral de roca molida, 25% resina.
- Standard: 1 faucet hole.  
Optional\*: 0 or 3 faucet hole.  
Standard: 1 taladro.  
Opcional\*: 0 o 3 taladros.
- Overflow: integrated.  
Rebosadero integrado.
- Drain 1 1/4". Compatible with click clack or fixed valve with small lid.  
Desagüe 1 1/4". Compatible con click clack o válvula fija con tapa pequeña.
- Valve cover.  
Tapa de válvula.

### CABINET MATCH COMPATIBILIDAD

- Époque.

### DIMENSIONS MEDIDAS

60

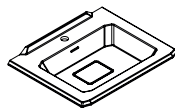

80

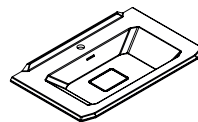

100

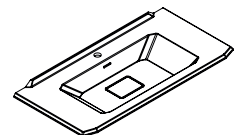

### FINISHES ACABADOS

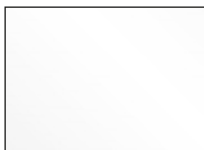

MINERAL COMPOSITE GLOSS  
GLOSS WHITE  
BLANCO BRILLO



MINERAL COMPOSITE MATT  
MATT WHITE  
BLANCO MATE

\*Consult conditions.  
\*Consultar condiciones.

# CERAMIC

SX7 | SX12

## MX10



### SPECS ESPECIFICACIONES

- Material: Mineral Solid® (Matt White).  
Material: Mineral Solid®.
- Composition: 75% natural minerals 25% polyester resin.  
Composición: 75% minerales naturales 25% resina de poliéster.
- Faucet hole:  
Standard: 1 faucet hole.  
Optional\*: 0 or 3 faucet hole.  
Standard: 1 taladro.  
Opcional\*: sin taladro.
- Overflow: integrated.  
Sin rebosadero.
- Drain 1 1/4".  
Desagüe 1 1/4".

### CABINET MATCH COMPATIBILIDAD

- Mitte.

### DIMENSIONS MEDIDAS

80

100

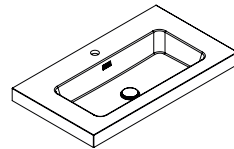
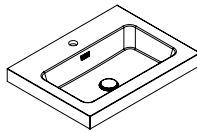

### FINISHES ACABADOS

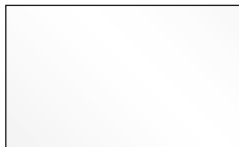

MINERAL GLOSS  
GLOSS WHITE



MINERAL MATT  
MATT WHITE



# CERAMIC

SX7 | SX12

## SX7



### SPECS ESPECIFICACIONES

- Material: Glazed ceramic.  
Material: Cerámica esmaltada
- Composition: natural material composed of clay and kaolin.  
Composición: material natural compuesto de arcilla y caolín.
- Faucet hole:  
Standard: 1 faucet hole.  
Optional\*: 0 or 3 faucet hole.  
Standard: 1 taladro.  
Opcional\*: sin taladro.
- Overflow: integrated.  
Sin rebosadero.
- Drain 1 1/4".  
Desagüe 1 1/4".

### CABINET MATCH COMPATIBILIDAD

- Play.
- Code.
- Essence

### DIMENSIONS MEDIDAS

60

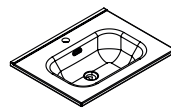

80

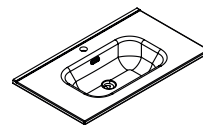

100

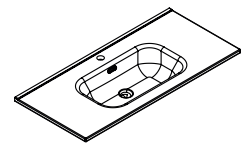

120

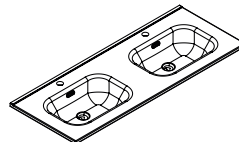

### FINISHES ACABADOS

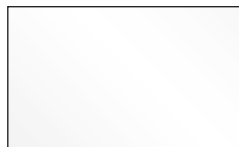

CERAMIC  
GLOSS WHITE

# CERAMIC

SX7 | SX12

## SX12



### SPECS ESPECIFICACIONES

- Material: Glazed ceramic.  
Material: Cerámica esmaltada.
- Composition: natural material composed of clay and kaolin.  
Composición: material natural compuesto de arcilla y caolín.
- Overflow: without.  
Sin rebosadero.
- Drain 1 1/4".  
Desagüe 1 1/4".
- 3 models.  
3 modelos.



### CABINET MATCH COMPATIBILIDAD

- Evolve with counter.  
Evolve con encimera.
- Mitte whith counter.  
Mitte con encimera.
- Puzzle with counter.  
Puzzle con encimera.

### DIMENSIONS MEDIDAS

44x32

Ø37

Ø28

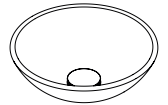
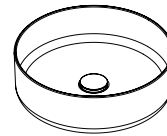
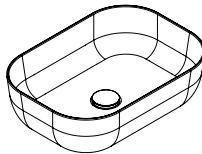

### FINISHES ACABADOS



WHITE STONE



TORTORA STONE

\*Consult conditions.  
\*Consultar condiciones.



## COUNTERS

	COUNTER			
	STONE		MINERAL MARMO SOLID	
	COMPACT STONE	MICROTECH	GLOSS BRILLO	MATT MATE
<b>IMPACT RESISTANCE</b> RESISTENCIA IMPACTOS	HIGH	MEDIUM	MEDIUM	MEDIUM
<b>SCRATCH RESISTANCE</b> RESISTENCIA RASGUÑOS	MEDIUM	MEDIUM	LOW	MEDIUM
<b>CHEMICALS RESISTANCE</b> RESISTENCIA A QUÍMICOS	MEDIUM	MEDIUM	MEDIUM	MEDIUM
<b>REPAIRABLE</b> REPARABLE	NO	NO	YES	YES
<b>FAUCET HOLE DRILLING</b> PERFORACIÓN	YES	YES	YES	YES
<b>CUT</b> CORTE	YES	YES	NO	YES
<b>MINIMUM RADIUS (MM)</b> RADIOS MÍNIMOS	2	2	2	2
<b>MATT INTENSITY</b> INTENSIDAD MATE	MEDIUM	MEDIUM	N/A	HIGH
<b>GLOSS INTENSITY</b> INTENSIDAD BRILLO	LOW	LOW	HIGH	N/A
<b>ABRASIVE CLEANING</b> LIMPIEZA ABRASIVA	NO	NO	NO	NO
<b>MICROFIBER CLEANING</b> LIMPIEZA MICROFIBRA	OK	OK	OK	OK

# STONE COUNTER

## MICROTECH



### SPECS ESPECIFICACIONES

- Material: Compact stone obtained from natural ground rock with a lamination process.  
Material: Piedra compacta obtenida de roca molida natural con proceso de laminación.
- Impact resistant  
Resistente a los impactos.
- Water proof.  
Resistente al agua.
- Standard: 0 faucet hole.  
Optional\*: 1 or 3 faucet hole.  
Standard: 0 taladro.  
Opcional\*: 1 o 3 taladros.
- Painted in different colors.  
Pintada en diferentes colores.

### COMPATIBILITY COMPATIBILIDAD

- Mitte. + Basin SX12.
- Evolve. + Lavabo SX12.
- Puzzle.

### DIMENSIONS MEDIDAS

50

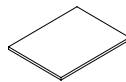

60

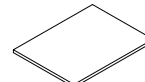

80

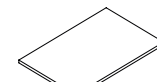

100

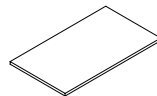

120

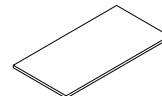

140

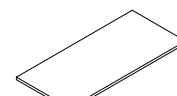

### FINISHES ACABADOS

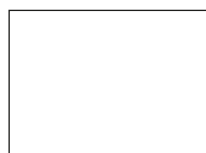

WHITE STONE



TORTORA STONE

\*Consult conditions.  
\*Consultar condiciones.

# STONE COUNTER

## COMPACT



### SPECS ESPECIFICACIONES

- Material: 100% natural stone counter ground and compacted.  
Material: Encimeras de piedra 100% natural, molida y compactada.
- Impact resistant  
Resistente a los impactos.
- Water proof.  
Resistente al agua.
- Standard: 0 faucet hole.  
Optional\*: 1 or 3 faucet hole.  
Standard: 0 taladro.  
Opcional\*: 1 o 3 taladros.
- To install on a base unit.  
Para instalar sobre el mueble.

### COMPATIBILITY COMPATIBILIDAD

- Evolve. + Basin SX12.  
+ Lavabo SX12.

### DIMENSIONS MEDIDAS

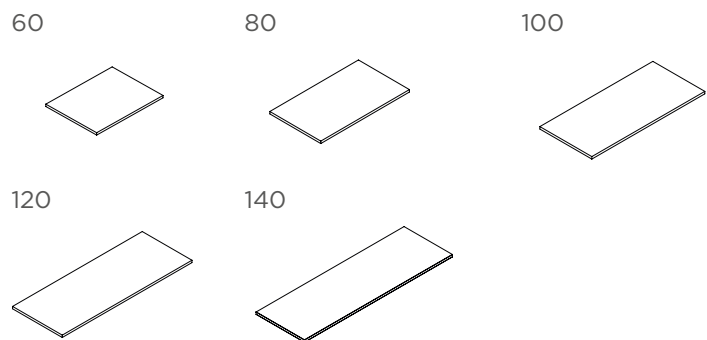

### FINISHES ACABADOS

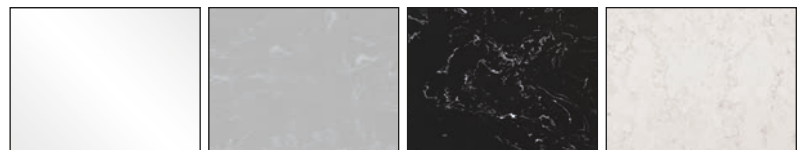

MINERAL MARMO

POLAR STONE

MARQUINA STONE

CALACATTA STONE

\*Consult conditions.  
\*Consultar condiciones.

# INDEX ÍNDICE





CODE · PAG 110



PLAY · PAG 94



PUZZLE · PAG 126



MIRRORS · PAG 136



LIGHTS · PAG 146



EVOLVE







**HUMIDITY RESISTANCE**  
RESISTENTE A LA HUMEDAD



**INSTALLATION TO THE WALL**  
INSTALACIÓN A PARED



**MAX LOAD CAPACITY**  
CAPACIDAD MÁXIMA



**DOUBLE LAYER PAINT**  
DOBLE CAPA PINTURA



**3/4" (19mm) HDF THICKNESS**  
3/4" 19MM ESPESOR



**SOFT CLOSE HARDWARE**  
CIERRE SUAVE



**CRAFTSMANSHIP**  
HECHO A MANO



**DRAWER ORGANIZER**  
CAJÓN ORGANIZADOR

	SPECS ESPECIFICACIONES TÉCNICAS	BENEFITS BENEFICIOS
STRUCTURE ESTRUCTURA	<p>Thicknesses throughout the furniture of 19 mm. Particle board. HDF PVC edges 0.8 mm PUR technology (Reactive Polyurethane) Espesores de todo el mueble de 19 mm. Tablero partículas. HDF Cantos PVC 0.8 mm, tecnología PUR (Polyuretano reactivo).</p>	<p>Structure robustness. Humidity resistance. Estructura robusta. Resistente a la humedad.</p>
DRAWERS CAJONES + DOORS PUERTAS	<p>12 mm ultraslim anthracite metal drawer. Drawer depth 19 mm. Full extraction. Load capacity 30 Kg Organizers included. Regulation and adjustments front. Cajón metálico antracita ultra slim 12mm. Fondo cajón 19 mm. Extracción total. Capacidad carga 30 Kg. Organizadores incluidos. Regulación y ajuste frentes.</p>	<p>Design, order and cleanliness. Soft close. Capacity. Diseño, orden y limpieza. Suavidad apertura / cierre silencioso. Capacidad.</p>
HANDLES TIRADORES	<p>Materials: stainless steel, zamak, aluminium. Fishing technology: Anodized, PVD, electrolyc, thermosetting coating. Materiales: acero inoxidable, zamak, aluminio. Tecnología acabados: Anodizados, PVD, electrolíticos, recubrimiento termoendurecido.</p>	<p>Wide range of metallic finishes: brushed gold, brushed nickel, white and black. Resistance and durability. Amplia gama de acabados metálicos: oro cepillado, nickel cepillado, blanco y negro. Resistencia y durabilidad.</p>
INSTALLATION INSTALACIÓN	<p>Hangers + wall plate. Compliance with all regulations and standarts. Drain valves in faucet finishes: chrome, gold, white, black. Patented flexible siphon. Colgadores + placa de pared. Cumplimiento de todas las normativas y estandares. Válvulas desagüe en acabados grifería: cromo, oro, blanco, negro. Sifón flexible patentado.</p>	<p>Reliability, safety installation. Design and combination with other elements. Maximize drawer space. Reduces costs and facilitates plumbing installation. Fiabilidad, seguridad instalación. Diseño y combinación con el resto de elementos. Maximiza el espacio del cajón. Reduce costes y facilita la instalación de fontanería.</p>
LACQUERED FINISHES ACABADOS LACADOS	<p>Double layed paint on laminated fiber. Soft matte finishes. Doble capa de pintura sobre fibra laminada. Acabados mate soft.</p>	<p>No aging. It looks like the first day. Hardness and resistance lacquered surface. No envejece. Mantiene aspecto como el primer día. Dureza y resistencia de superficies lacadas.</p>
WOOD FINISHES ACABADOS MADERA	<p>Latest technology laminates with synchronized grain. Laminados última tecnología con veta sincronizada.</p>	<p>Ultra natural realism. They improve the resistance and properties of the natural veneer. Ultrarealismo natural. Mejoran la resistencia y las propiedades de la chapa natural.</p>
BASINS LAVABOS	<p>See features / washbasin range Ver características / gama lavabos</p>	

# EVOLVE

THE BEAUTY OF ART DECO



## BASE UNIT MUEBLE

20 cm  
40 cm  
60 cm  
70 cm



BLANCO SOFT



ANTHRACITE SOFT



OAK WOOD

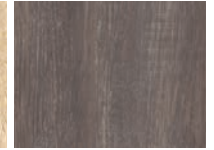

STORM WOOD

## FINISHES ACABADOS



## METAL LEGS (OPTIONAL) PATAS METÁLICAS (OPCIONAL)

100 cm  
120 cm  
140 cm



BLACK MATTE

## FINISHES ACABADOS



## HANDLES TIRADORES

Evo  
Line  
Moon



BRUSHED GOLD



BRUSHED NICKEL



WHITE



BLACK

## FINISHES ACABADOS



## BASIN LAVABOS

MX3  
SX12 / 44x32  
SX12 / Ø37



WHITE MATTE  
CERAMIC



MINERAL SOLID



DARK GREY MATTE  
CERAMIC



BLACK MATTE  
CERAMIC



TORTORA

## FINISHES ACABADOS



## COUNTER ENCIMERA

60cm  
80cm  
100cm  
120cm  
140cm

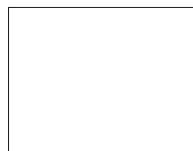

WHITE STONE

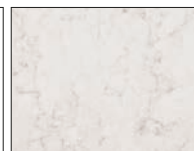

CALACATTA STONE



POLAR STONE

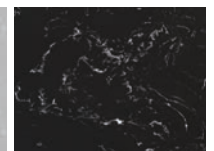

MARQUINA STONE

## FINISHES ACABADOS

# EVOLVE

---



EVOLVE



EVOLVE

---





# EVOLVE

---





EVOLVE







EVOLVE

---





# EVOLVE

---



EVOLVE

---



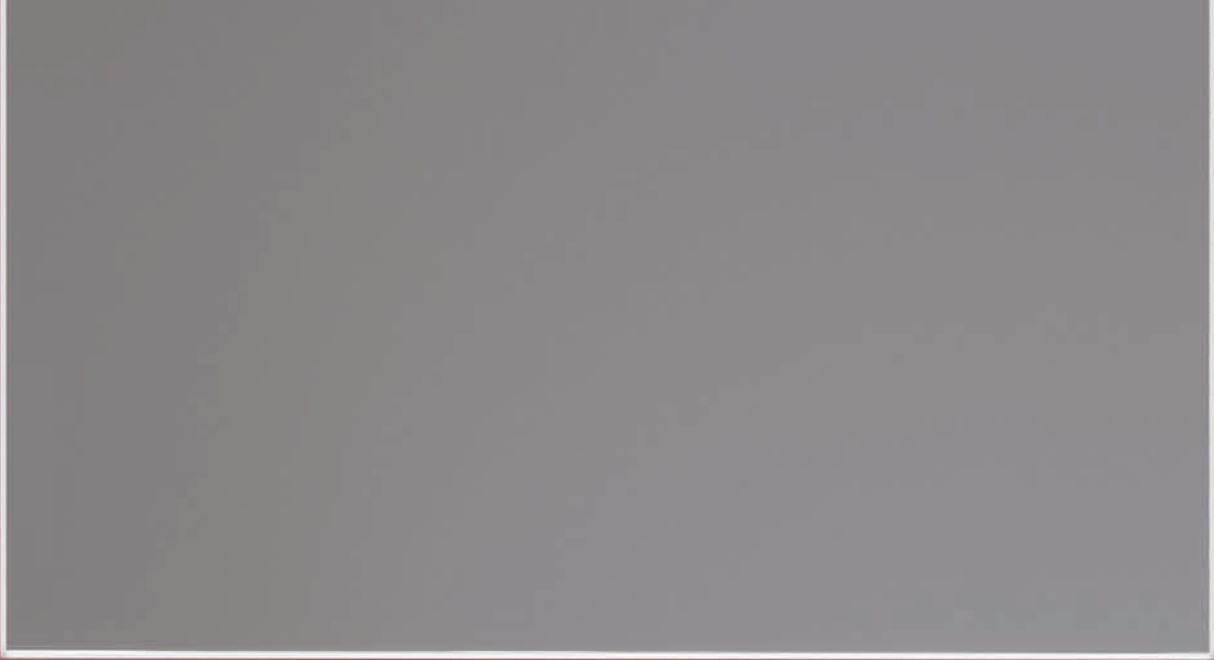





# EVOLVE

---



EVOLVE



# EVOLVE

---





EVOLVE

---





# EVOLVE

## MOST POPULARS



### 100CM COMBINATION

- Step 1 | Furniture  
+ 187300 | 40 cm | Oak wood  
+ 187485 | 60 cm | Blanco Soft
- Step 2 | Metal legs  
+ 187812 | 100 cm | Black Matte
- Step 3 | Handles  
+ 3 x 167135 | Evo | White
- Step 4 | Basin  
+ 168583 | 100 cm | MX3 |  
Mineral Solid (Blanco Mate)



### 120CM COMBINATION

- Step 1 | Furniture  
+ 187300 | 40 cm | Oak wood  
+ 166909 | 20 cm | Anthracite Soft  
+ 187553 | 60 cm | Anthracite Soft
- Step 2 | Metal legs  
+ 187812 | 100 cm | Black Matte
- Step 3 | Handles  
+ 3 x 181094 | Evo | Brushed Nickel
- Step 4 | Counter 120  
+ 191888+(40-20-60:1Ø) | Marquina Stone  
Basin  
+ 188703 | 43x32 cm | Black Matte Ceramic



### 120CM COMBINATION

- Step 1 | Furniture  
+ 187577 | 60 cm | Oakwood  
+ 187577 | 60 cm | Oakwood
- Step 2 | Metallic legs  
+ 187812 | 100 cm | Black Matte
- Step 3 | Handles  
+ 4 x 187706 | Moon | Black
- Step 4 | Basin  
+ 168613 | 120 cm | MX3 |  
Mineral Solid (Blanco Mate)



## MOST POPULARS



### 140CM COMBINATION

- Step 1 | Furniture  
+ 187485 | 60 cm | Blanco soft  
+ 165933 | 20 cm | Blanco soft  
+ 187485 | 60 cm | Blanco soft
- Step 2 | Handles  
+ 4 x 187720 | Moon | Brushed Gold
- Step 3 | Counter 140  
+ 191772+(60:1Ø-20-60:1Ø) | Calacatta Stone
- Step 4 | Basin  
+ 2 x 187331 | Ø37 | White Matt Ceramic



### 140CM COMBINATION:

- Step 1 | Furniture  
+ 187546 | 60 cm | Blanco soft  
+ 165933 | 20 cm | Blanco soft  
+ 187546 | 60 cm | Blanco soft
- Step 2 | Metallic legs  
+ 188666 | 140 cm | Black
- Step 3 | Handles  
+ 4 x 187706 | Moon | Black
- Step 4 | Counter 140  
+ 191895+(60:1Ø-20-60:1Ø) | Marquina Stone  
Basin  
+ 2 x 187331 | Ø37 | White Matt Ceramic

# EVOLVE

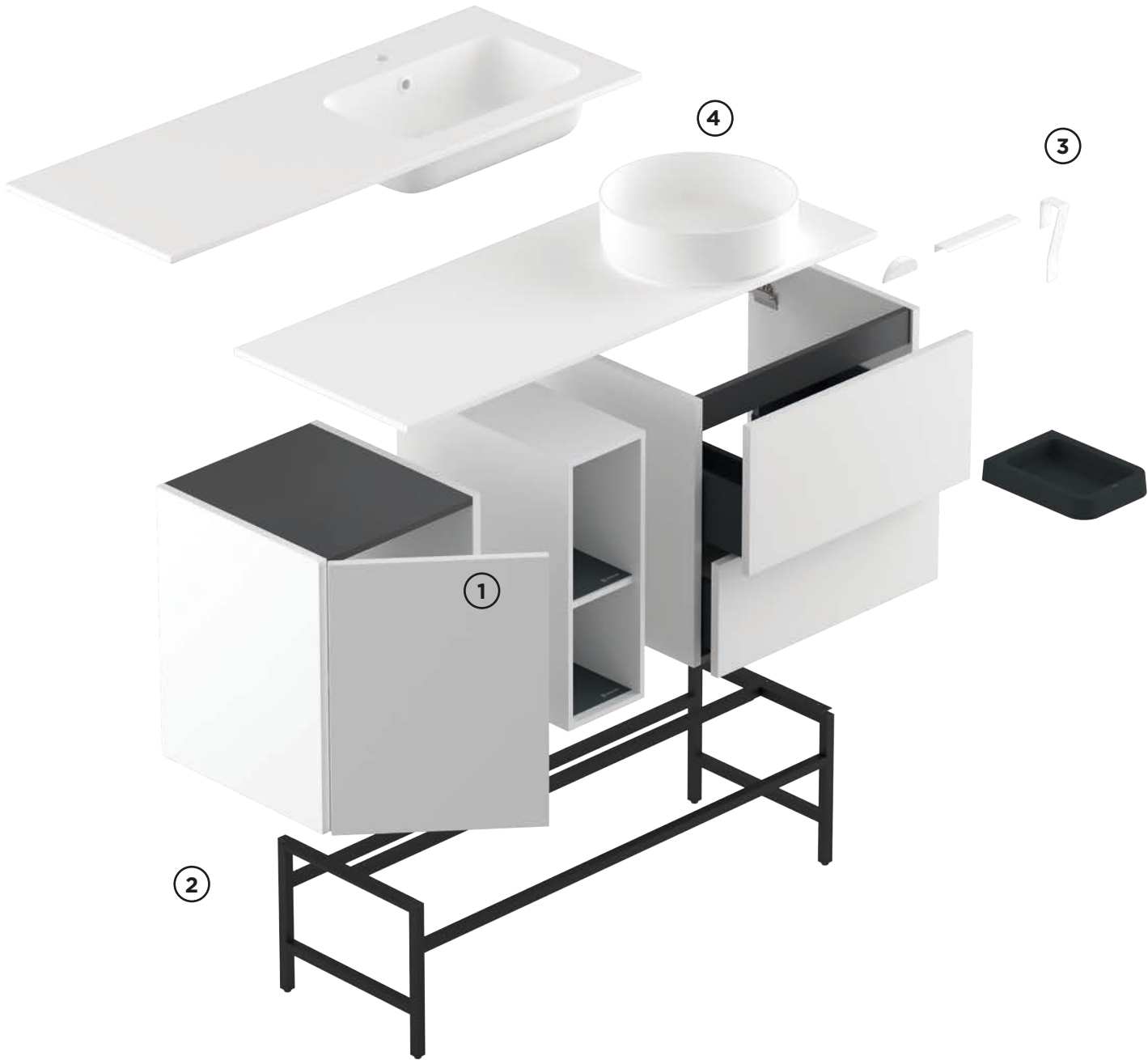

## CREATE YOUR EVOLVE CREA TU EVOLVE

### STEP 1

#### SELECT BASE UNITS COMBINATION

SELECCIONA LA COMBINACIÓN DEL ARMAZÓN

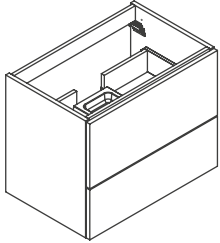

70 cm (28")

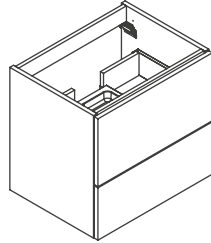

60 cm (24")

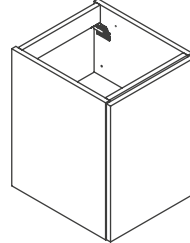

40 cm (16")

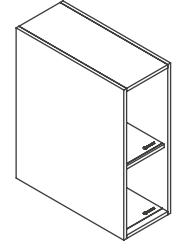

20 cm (8")

### STEP 2

#### SELECT THE METAL LEGS

SELECCIONA LAS PATAS METÁLICAS

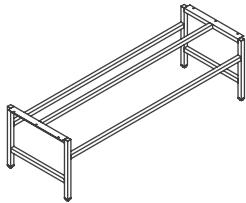

100 cm | 120 cm | 140 cm  
40" | 48" | 56"

### STEP 3

#### SELECT THE SET OF HANDLES

SELECCIONA EL SET DE TIRADORES



EVO

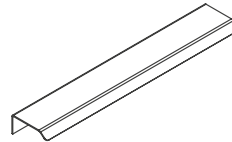

LINE

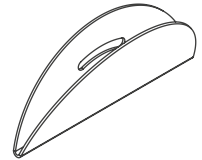

MOON

### STEP 4

#### SELECT THE BASIN

SELECCIONA EL LAVABO

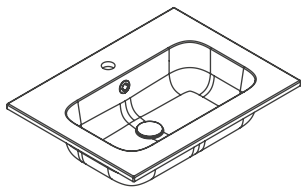

MX3

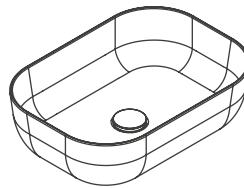

SX12 / 44x32

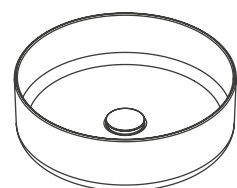

SX12 / Ø37

### STEP 5

#### SELECT THE COUNTERTOP

SELECCIONA EL LAVABO

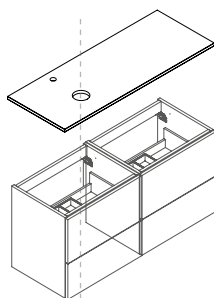

24" + 24"  
60 cm + 60 cm

LEFT  
IZQUIERDA

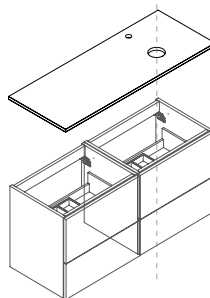

24" + 24"  
60 cm + 60 cm

RIGHT  
DERECHA

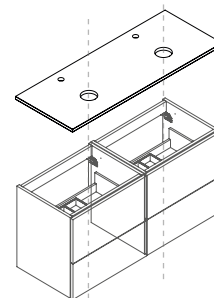

24" + 24"  
60 cm + 60 cm

DOUBLE  
DOBLE

# EVOLVE

---



## BASE UNIT FINISH OPTIONS

---

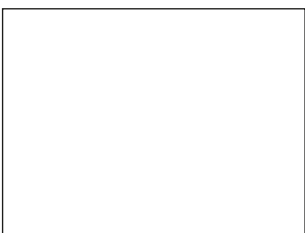

BLANCO SOFT  
Ref. 99922240



ANTHRACITE SOFT  
Ref. 9992225R

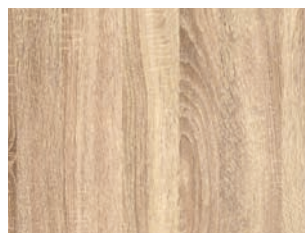

OAK WOOD  
Ref. 9992225G

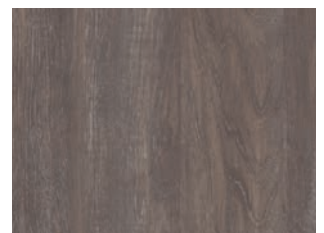

STORM WOOD  
Ref. 9992226B

**STEP 1**  
**BASE UNIT**  
**ARMAZÓN**

**STEP 2**  
**METAL LEGS**  
**PATAS METÁLICAS**

**STEP 3**  
**HANDLES**  
**TIRADORES**

**STEP 4**  
**COUNTER / ENCIMERA**  
**BASIN / LAVABO**

**STEP 1 - SELECT THE BASE UNIT**  
**STEP 1 - SELECCIONA EL ARMAZÓN**

**70 CM TWO DRAWERS BASE UNIT (28")**  
**ARMAZÓN DOS CAJONES 70 CM (28")**

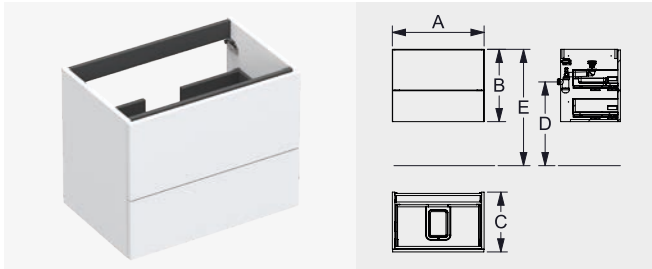

BLANCO SOFT  
 ANTHRACITE SOFT  
 OAKWOOD  
 STORMWOOD

Ref. 181636  
 Ref. 181612  
 Ref. 187577  
 Ref. 187591

A: 698 mm. B: 550 mm. C: 455 mm.  
 D: 637 mm. E: 885 mm.

**60 CM TWO DRAWERS BASE UNIT (24")**  
**ARMAZÓN DOS CAJONES 60 CM (24")**

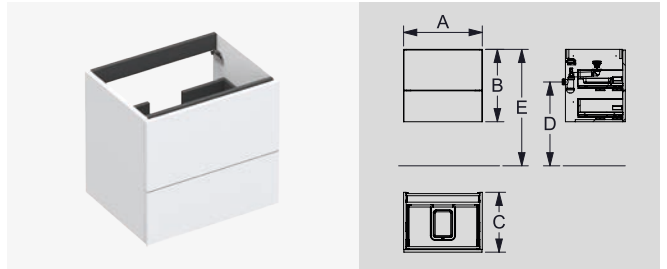

BLANCO SOFT  
 ANTHRACITE SOFT  
 OAKWOOD  
 STORMWOOD

Ref. 187485  
 Ref. 170555  
 Ref. 187515  
 Ref. 187539

A: 598 mm. B: 550 mm. C: 455 mm.  
 D: 637 mm. E: 885 mm.

**20 CM BASE UNIT (8")**  
**ARMAZÓN 20 CM (8")**

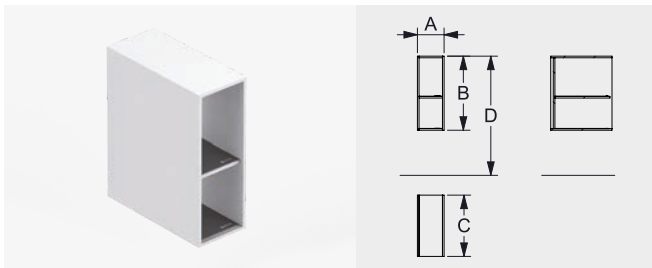

BLANCO SOFT  
 ANTHRACITE SOFT

Ref. 165933  
 Ref. 166909

A: 198 mm. B: 550 mm.  
 C: 455 mm. D: 885 mm.

**40 CM DOOR BASE UNIT (16")**  
**ARMAZÓN PUERTA 40 CM (16")**

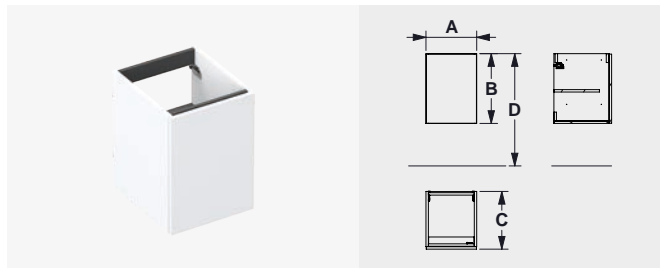

BLANCO SOFT  
 ANTHRACITE SOFT  
 OAKWOOD  
 STORMWOOD

Ref. 166930  
 Ref. 166954  
 Ref. 187300  
 Ref. 187324

A: 398 mm. B: 550 mm.  
 C: 455 mm. D: 885 mm.

Reversible doors. Choose right or left opening.  
 Puertas reversibles. Elije apertura derecha o izquierda.

**120 CM WALL VITRINE (47")**  
**COLUMNA 120 CM (47")**



BLANCO SOFT  
 ANTHRACITE SOFT  
 OAKWOOD  
 STORMWOOD

Ref. 188161  
 Ref. 189588  
 Ref. 172702  
 Ref. 187256

A: 350 mm. B: 1200 mm. C: 261 mm.

CREATE YOUR EVOLVE / CREA TU EVOLVE

STEP 1  
BASE UNIT  
ARMAZÓN

STEP 2  
METAL LEGS  
PATAS METÁLICAS

STEP 3  
HANDLES  
TIRADORES

STEP 4  
COUNTER / ENCIMERA  
BASIN / LAVABO

STEP 2 - SELECT THE LEG (OPTIONAL)  
STEP 2 - SELECCIONA LAS PATAS (OPCIONAL)

BALCK METAL LEGS  
ESTRUCTURA PATAS METÁLICAS NEGRAS

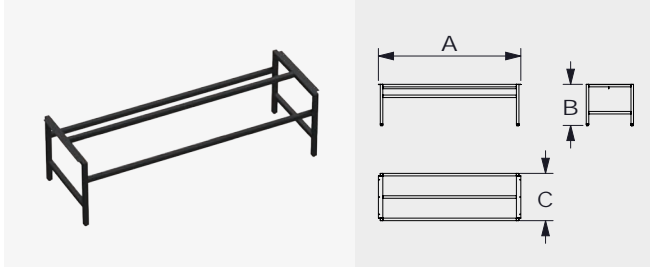

A = 1000 mm  
A = 1200 mm  
A = 1400 mm

Ref. 187812  
Ref. 188642  
Ref. 188666

B: 326 mm. C: 375 mm.

METAL LEGS FINISH OPTIONS  
OPCIONES DE ACABADO DE LA ESTRUCTURA DE PATAS



BLACK MATTE



STEP 1  
BASE UNIT  
ARMAZÓN

STEP 2  
METAL LEGS  
PATAS METÁLICAS

STEP 3  
HANDLES  
TIRADORES

STEP 4  
COUNTER / ENCIMERA  
BASIN / LAVABO

STEP 3 - SELECT THE HANDLES  
STEP 3 - SELECCIONA LOS TIRADORES

EVO HANDLE  
TIRADOR EVO

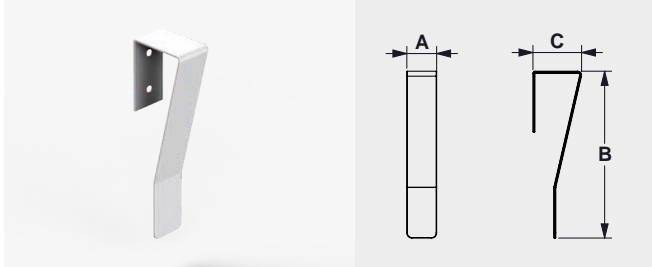

WHITE  
BLACK  
BRUSHED NICKEL  
BRUSHED GOLD

Ref. 167135  
Ref. 186198  
Ref. 181094  
Ref. 181100

A: 30 mm. B: 165 mm. C: 50 mm.

LINE HANDLE  
TIRADOR LINE

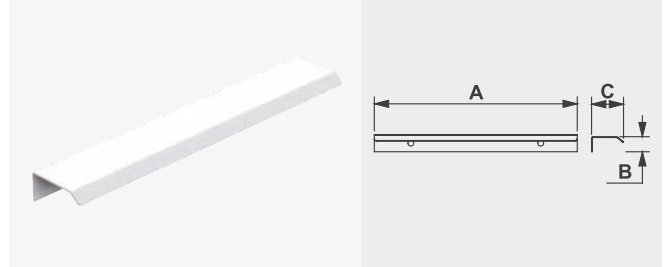

WHITE  
BLACK  
BRUSHED NICKEL

Ref. 167197  
Ref. 189335  
Ref. 191918

A: 198 mm. B: 7 mm. C: 20 mm.

MOON HANDLE  
TIRADOR MOON

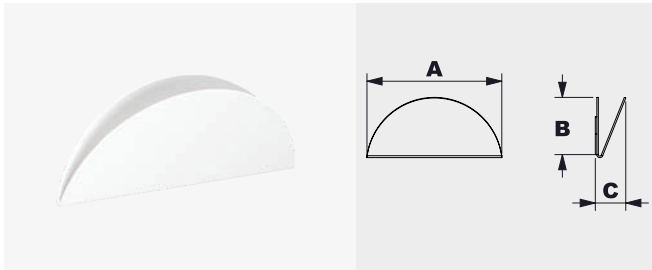

WHITE  
BLACK  
BRUSHED NICKEL  
BRUSHED GOLD

Ref. 187690  
Ref. 187706  
Ref. 187713  
Ref. 187720

A: 90 mm. B: 38 mm. C: 21 mm.

HANDLES FINISH OPTIONS  
OPCIONES DE ACABADO DE LOS TIRADORES



WHITE



BRUSHED NICKEL



BLACK



BRUSHED GOLD

# EVOLVE

MX3



FINISH COUNTER  
ACABADO LAVABO

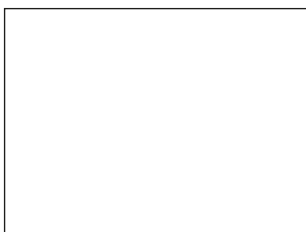

WHITE MINERAL SOLID



STEP 1  
BASE UNIT  
ARMAZÓN

STEP 2  
METAL LEGS  
PATAS METÁLICAS

STEP 3  
HANDLES  
TIRADORES

STEP 4  
COUNTER / ENCIMERA  
BASIN / LAVABO

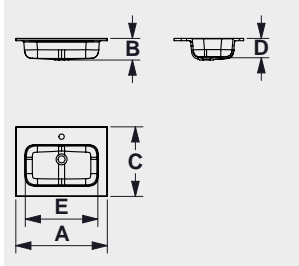

A: 605 mm. B: 143 mm. C: 460 mm.  
D: 128 mm. E: 480 mm.



Clicker not included  
Clicker no incluido

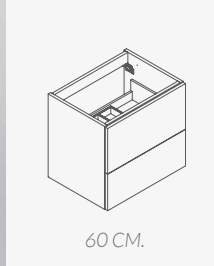

60 CM MX3 BASIN 1Ø (24")  
LAVABO MX3 60 CM 1Ø (24")

MINERAL SOLID Ref. 168545

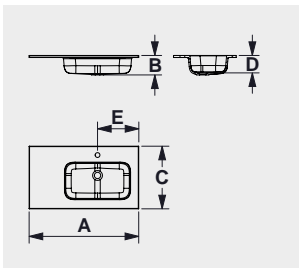

A: 805 mm. B: 143 mm. C: 460 mm.  
D: 120 mm. E: 300 mm.



Clicker not included  
Clicker no incluido

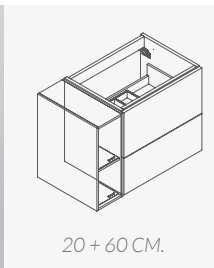

80 CM MX3 BASIN 1Ø OFFSET RIGHT (32")  
LAVABO MX3 80 CM 1Ø DCHA. (32")

MINERAL SOLID Ref. 168569

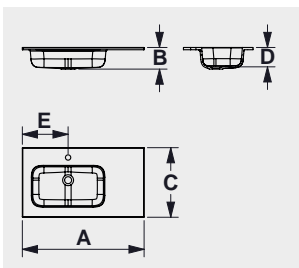

A: 805 mm. B: 143 mm. C: 460 mm.  
D: 128 mm. E: 300 mm.



Clicker not included  
Clicker no incluido

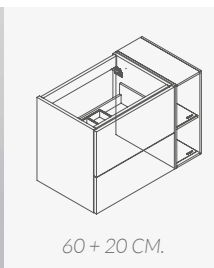

80 CM MX3 BASIN 1Ø OFFSET LEFT (32")  
LAVABO MX3 80 CM 1Ø IZDA. (32")

MINERAL SOLID Ref. 168552

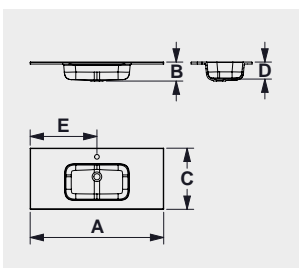

A: 1005 mm. B: 143 mm. C: 460 mm.  
D: 128 mm. E: 502,5 mm.



Clicker not included  
Clicker no incluido

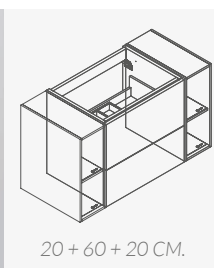

100 CM MX3 BASIN 1Ø (40")  
LAVABO MX3 100 CM 1Ø (40")

MINERAL SOLID Ref. 168897

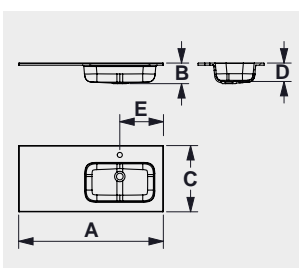

A: 1005 mm. B: 143 mm. C: 460 mm.  
D: 128 mm. E: 300 mm.



Clicker not included  
Clicker no incluido

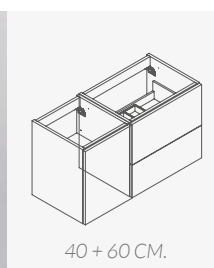

100 CM MX3 BASIN 1Ø OFFSET RIGHT (40")  
LAVABO MX3 100 CM 1Ø DCHA. (40")

MINERAL SOLID Ref. 168583

CREATE YOUR EVOLVE

STEP 1  
BASE UNIT  
ARMAZÓN

STEP 2  
METAL LEGS  
PATAS METÁLICAS

STEP 3  
HANDLES  
TIRADORES

STEP 4  
COUNTER / ENCIMERA  
BASIN / LAVABO

100 CM MX3 BASIN 1Ø OFFSET LEFT (40")  
LAVABO MX3 100 CM 1Ø IZDA. (40")

MINERAL SOLID Ref. 168576



60 + 20 CM.

Clicker not included / Clicker no incluido  
A: 1005 mm. B: 143 mm. C: 460 mm.  
D: 128 mm. E: 300 mm.

120 CM MX3 BASIN 1Ø DOUBLE (48")  
LAVABO MX3 120 CM 1Ø DOBLE (48")

MINERAL SOLID Ref. 168613



60 + 60 CM.

Clicker not included / Clicker no incluido  
A: 1205 mm. B: 143 mm. C: 460 mm.  
D: 128 mm. E: 570 mm.

120 CM MX3 BASIN 1Ø OFFSET RIGHT (48")  
LAVABO MX3 120 CM 1Ø DCHA. (48")

MINERAL SOLID Ref. 168606



60 + 60 CM.

Clicker not included / Clicker no incluido  
A: 1205 mm. B: 143 mm. C: 460 mm.  
D: 128 mm. E: 300 mm.

120 CM MX3 BASIN 1Ø OFFSET LEFT (48")  
LAVABO MX3 120 CM 1Ø IZDA. (48")

MINERAL SOLID Ref. 168590



60 + 60 CM.

Clicker not included / Clicker no incluido  
A: 1205 mm. B: 143 mm. C: 460 mm.  
D: 128 mm. E: 300 mm.

120 CM MX3 BASIN 1Ø OFFSET RIGHT (48")  
LAVABO MX3 120 1Ø DCHA. (48")

MINERAL SOLID Ref. 168606



240 + 20 + 60 CM.

Clicker not included / Clicker no incluido  
A: 1205 mm. B: 143 mm. C: 460 mm.  
D: 128 mm. E: 300 mm.

STEP 1  
BASE UNIT  
ARMAZÓN

STEP 2  
METAL LEGS  
PATAS METÁLICAS

STEP 3  
HANDLES  
TIRADORES

STEP 4  
COUNTER / ENCIMERA  
BASIN / LAVABO

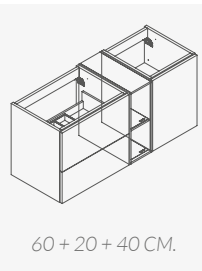
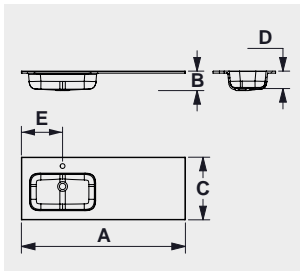

120 CM MX3 BASIN 1Ø OFFSET LEFT (48")  
LAVABO MX3 120 CM 1Ø IZDA. (48")

MINERAL SOLID Ref. 168590

A: 1205 mm B: 143 mm C: 460 mm Clicker not included  
D: 128 mm E: 300 mm Clicker no incluido

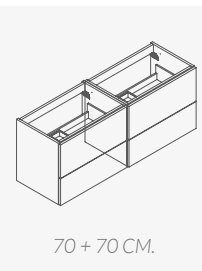
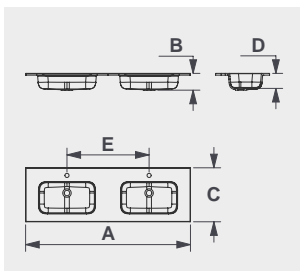

140 CM MX3 BASIN 1Ø DOUBLE (56")  
LAVABO MX3 140 CM 1Ø DOBLE (56")

MINERAL SOLID Ref. 176106

A: 1405 mm B: 143 mm C: 460 mm Clicker not included  
D: 128 mm E: 700 mm Clicker no incluido

TRAP COVER TRAY  
BANDEJA CUBRE SIFÓN

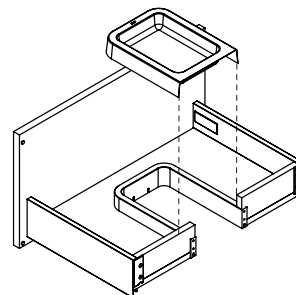
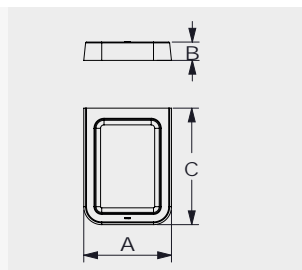
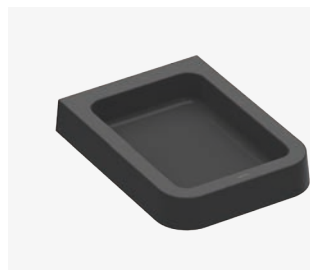

GRAPHITE Ref. 190126  
WHITE / BLANCO Ref. 190119

COMPLETE YOUR INSTALLATION  
COMPLETA TU INSTALACIÓN

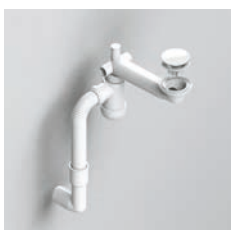

PRELOC + CLICKER  
TRAP 1¼" + VALVE  
SIFÓN 1¼" + VÁLVULA

CLICKER CHROME Ref. 161508  
CLICKER WHITE Ref. 190102

# EVOLVE



## SX12 BASIN - FINISHES ACABADOS LAVABOS SX12



WHITE MATTE CERAMIC



TORTORA

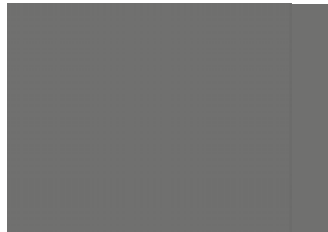

DARK GREY MATTE CERAMIC



BLACK MATTE CERAMIC

## COMPACT COUNTER - FINISHES ACABADOS ENCIMERA COMPACTA

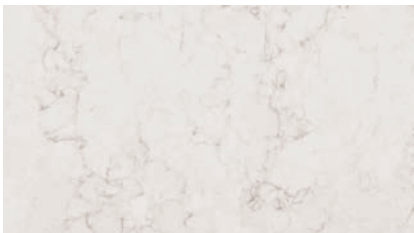

CALACATTA STONE



POLAR STONE

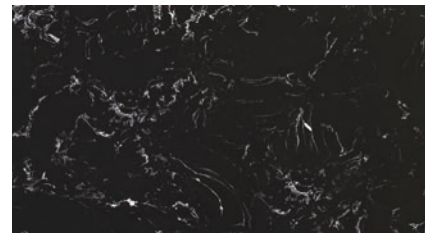

MARQUINA STONE

## MICROTECH COUNTER FINISHES ACABADOS ENCIMERA MICROTECH



WHITE STONE

STEP 1  
BASE UNIT  
ARMAZÓN

STEP 2  
METAL LEGS  
PATAS METÁLICAS

STEP 3  
HANDLES  
TIRADORES

STEP 4  
COUNTER / ENCIMERA  
BASIN / LAVABO

## OPTIONS BASIN + COUNTERTOP OPCIONES LAVABO + ENCIMERA

Example: counter 120 cm.  
Ejemplo: encimera 120 cm.

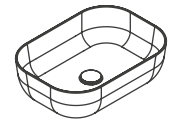
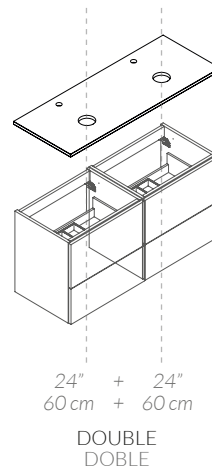
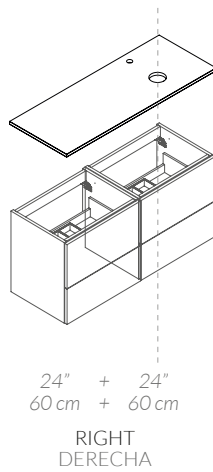
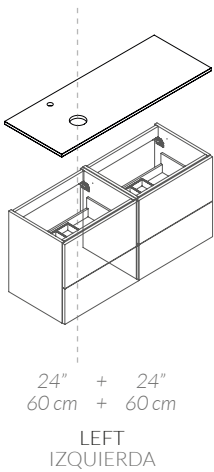

SX12 / 44x32

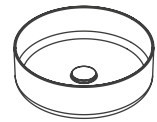

SX12 / Ø37



- |                  |   |
|------------------|---|
| Step 1<br>Paso 1 | Furniture 120 cm Armazón 120 cm<br>+ 187300   40 cm   Oakwood<br>+ 166909   20 cm   Anthracite Soft<br>+ 187553   60 cm   Anthracite Soft |
| Step 2<br>Paso 2 | Metal Legs Patas metálicas<br>+ 187812   120 cm   Black Matte   |
| Step 3<br>Paso 3 | Handles Tiradores<br>+ 3 x 181094   Evo   Brushed Nickel  |
| Step 4<br>Paso 4 | Counter Encimera<br>+ 189243 (40-20-60:1Ø)   Marquina Stone<br>Basin Lavabo<br>+ 188703   43x32 cm   Black Matte Ceramic                  |

- |                  |   |
|------------------|---|
| Step 1<br>Paso 1 | Furniture 140 cm Armazón 140 cm<br>+ 187546   60 cm   Blanco soft<br>+ 165933   20 cm   Blanco soft<br>+ 187546   60 cm   Blanco soft |
| Step 2<br>Paso 2 | Metal Legs Patas metálicas<br>+ 188666   140 cm   Black Matte   |
| Step 3<br>Paso 3 | Handles Tiradores<br>+ 4 x 187706   Moon   Black  |
| Step 4<br>Paso 4 | Counter Encimera<br>+ 189106   Marquina Stone<br>Basin Lavabo<br>+ 2 x 187331   Ø37   White Matt Ceramic                              |

STEP 1  
BASE UNIT  
ARMAZÓN

STEP 2  
METAL LEGS  
PATAS METÁLICAS

STEP 3  
HANDLES  
TIRADORES

STEP 4  
COUNTER / ENCIMERA  
BASIN / LAVABO

STEP 4 - SELECT THE BASIN  
STEP 4 - ESCOGE EL LAVABO

SX12 BASIN CERAMIC 44x32  
SX12 LAVABO CERÁMICA 44x32

WHITE MATT CERAMIC Ref. 187362  
TORTORA MATT CERAMIC Ref. 187379  
DARK GREY MATT CERAMIC Ref. 187386  
BLACK MATT CERAMIC Ref. 188703



A: 455 mm. B: 135 mm. C: 325 mm. D: 109 mm.  
\*Clicker not included

SX12 BASIN CERAMIC Ø37  
SX12 LAVABO CERÁMICA Ø37

WHITE MATT CERAMIC Ref. 187331  
TORTORA MATT CERAMIC Ref. 187348  
DARK GREY MATT CERAMIC Ref. 187355  
BLACK MATT CERAMIC Ref. 188697



A: 370 mm. B: 120 mm. D: 91 mm.  
\*Clicker not included

COMPLETE YOUR INSTALLATION  
COMPLETA TU INSTALACIÓN

TRAP COVER TRAY  
BANDEJA CUBRE SIFÓN

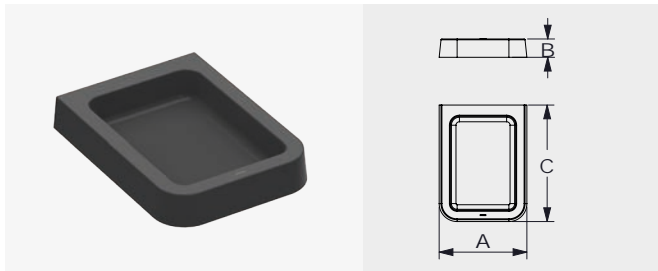

GRAPHITE  
WHITE / BLANCO

Ref. 190126  
Ref. 190119

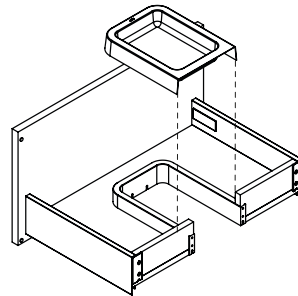

TRAP  
WASTEP-TRAP 1 1/4"

CHROME

Ref. 097388



CLICKER  
PUSH DOWN  
Ø 65 MM 1 1/4"  
CHROME  
WHITE  
BLACK  
TORTORA  
DARK GREY

Ref. 123940  
Ref. 188895  
Ref. 188888  
Ref. 188901  
Ref. 188918



PRELOC + CLICKER  
TRAP 1 1/4"  
SIFÓN 1 1/4"  
CLICKER CHROME  
CLICKER WHITE

Ref. 161508  
Ref. 190102

STEP 1  
BASE UNIT  
ARMAZÓN

STEP 2  
METAL LEGS  
PATAS METÁLICAS

STEP 3  
HANDLES  
TIRADORES

STEP 4  
COUNTER / ENCIMERA  
BASIN / LAVABO

60 CM COMBINATIONS (24")  
COMBINACIONES 60 CM (24")

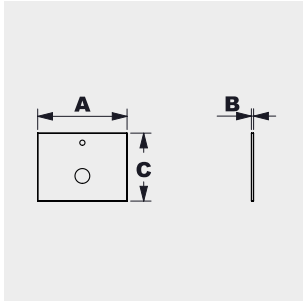

A-CENTER  
A-CENTRO

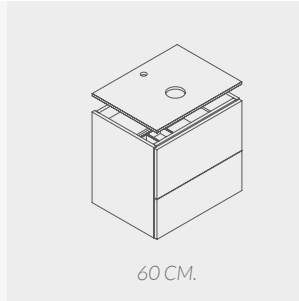

COMPACT COUNTER 1Ø  
COMPACT ENCIMERA 1Ø

CALACATTA STONE	Ref. 188925
POLAR STONE	Ref. 195923
MARQUINA STONE	Ref. 188932

MICROTECH COUNTER 1Ø  
MICROTECH ENCIMERA 1Ø

WHITE STONE	Ref. 188109
-------------	-------------

COMPACT = A: 605 mm. B: 20 mm. C: 460 mm.  
MICROTECH = A: 605 mm. B: 15 mm. C: 460 mm.

70 CM COMBINATIONS (24")  
COMBINACIONES 70 CM (24")

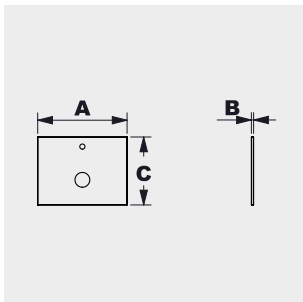

A-CENTER  
A-CENTRO

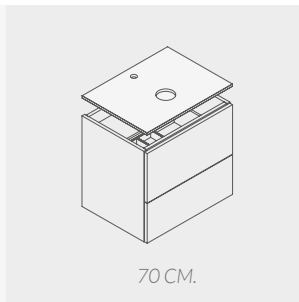

COMPACT COUNTER 0Ø  
COMPACT ENCIMERA 0Ø

CALACATTA STONE	Ref. 188949
POLAR STONE	Ref. 195930
MARQUINA STONE	Ref. 188956

MICROTECH COUNTER 0Ø  
MICROTECH ENCIMERA 0Ø

WHITE STONE	Ref. 188710
-------------	-------------

COMPACT = A: 605 mm. B: 20 mm. C: 460 mm.  
MICROTECH = A: 605 mm. B: 15 mm. C: 460 mm.

STEP 1  
BASE UNIT  
ARMAZÓN

STEP 2  
METAL LEGS  
PATAS METÁLICAS

STEP 3  
HANDLES  
TIRADORES

STEP 4  
COUNTER / ENCIMERA  
BASIN / LAVABO

80 CM COMBINATIONS (32")  
COMBINACIONES 80 CM (32")

COMPACT COUNTER 1Ø  
COMPACT ENCIMERA 1Ø

CALACATTA STONE Ref. 188963  
POLAR STONE Ref. 195947  
MARQUINA STONE Ref. 188970

MICROTECH COUNTER 1Ø  
MICROTECH ENCIMERA 1Ø

WHITE STONE Ref. 189342



COMPACT = A: 805 mm. B: 20 mm. C: 460 mm. D: 300 mm.  
MICROTECH = A: 805 mm. B: 15 mm. C: 460 mm. D: 300 mm.

COMPACT COUNTER 1Ø  
COMPACT ENCIMERA 1Ø

CALACATTA STONE Ref. 189151  
POLAR STONE Ref. 195954  
MARQUINA STONE Ref. 189168

MICROTECH COUNTER 0Ø  
MICROTECH ENCIMERA 1Ø

WHITE STONE Ref. 189410



COMPACT = A: 805 mm. B: 20 mm. C: 460 mm. D: 300 mm.  
MICROTECH = A: 805 mm. B: 15 mm. C: 460 mm. D: 300 mm.

100 CM COMBINATIONS (40")  
COMBINACIONES 100 CM (40")

COMPACT COUNTER 1Ø  
COMPACT ENCIMERA 1Ø

CALACATTA STONE Ref. 195978  
POLAR STONE Ref. 195961  
MARQUINA STONE Ref. 195985

MICROTECH COUNTER 1Ø  
MICROTECH ENCIMERA 1Ø

WHITE STONE Ref. 187409



COMPACT = A: 1005 mm. B: 20 mm. C: 460 mm.  
MICROTECH = A: 1005 mm. B: 15 mm. C: 460 mm.

COMPACT COUNTER 1Ø  
COMPACT ENCIMERA 1Ø

CALACATTA STONE Ref. 189007  
POLAR STONE Ref. 195992  
MARQUINA STONE Ref. 187805

MICROTECH COUNTER 0Ø  
MICROTECH ENCIMERA 1Ø

WHITE STONE Ref. 189359



COMPACT = A: 1005 mm. B: 20 mm. C: 460 mm. D: 300 mm.  
MICROTECH = A: 1005 mm. B: 15 mm. C: 460 mm. D: 300 mm.



STEP 1  
BASE UNIT  
ARMAZÓN

STEP 2  
METAL LEGS  
PATAS METÁLICAS

STEP 3  
HANDLES  
TIRADORES

STEP 4  
COUNTER / ENCIMERA  
BASIN / LAVABO

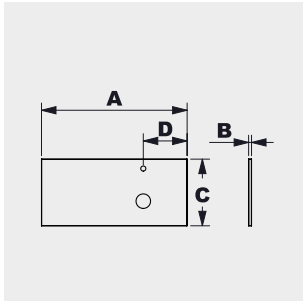

A-RIGHT  
A-DERECHA

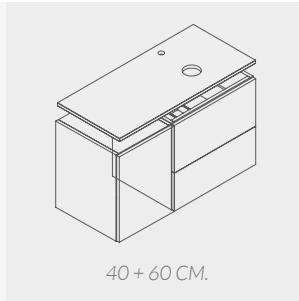

COMPACT COUNTER 1Ø  
COMPACT ENCIMERA 1Ø

CALACATTA STONE Ref. 189199  
POLAR STONE Ref. 196005  
MARQUINA STONE Ref. 189205

MICROTECH COUNTER 1Ø  
MICROTECH ENCIMERA 1Ø

WHITE STONE Ref. 189434

40 + 60 CM.

COMPACT = A: 605 mm. B: 20 mm. C: 460 mm. D: 300 mm.  
MICROTECH = A: 605 mm. B: 15 mm. C: 460 mm. D: 300 mm.

120 CM COMBINATIONS (48")

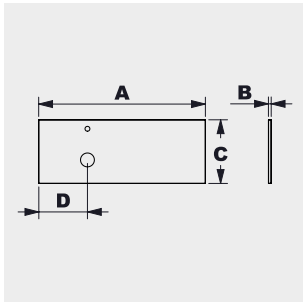

A-LEFT  
A-IZQUIERDA

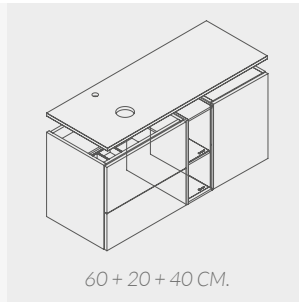

COMPACT COUNTER 1Ø  
COMPACT ENCIMERA 1Ø

CALACATTA STONE Ref. 189038  
POLAR STONE Ref. 196012  
MARQUINA STONE Ref. 189045

MICROTECH COUNTER 1Ø  
MICROTECH ENCIMERA 1Ø

WHITE STONE Ref. 189373

60 + 20 + 40 CM.

COMPACT = A: 1205 mm. B: 20 mm. C: 460 mm. D: 300 mm.  
MICROTECH = A: 1205 mm. B: 15 mm. C: 460 mm. D: 300 mm.

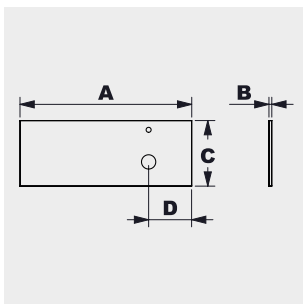

A-RIGHT  
A-DERECHA

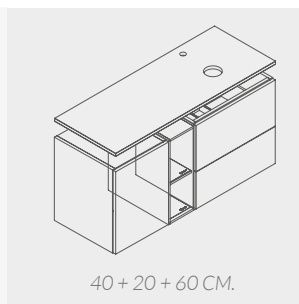

COMPACT COUNTER 1Ø  
COMPACT ENCIMERA 1Ø

CALACATTA STONE Ref. 189236  
POLAR STONE Ref. 196029  
MARQUINA STONE Ref. 189243

MICROTECH COUNTER 0Ø  
MICROTECH ENCIMERA 1Ø

WHITE STONE Ref. 189441

40 + 20 + 60 CM.

COMPACT = A: 1205 mm. B: 20 mm. C: 460 mm. D: 300 mm.  
MICROTECH = A: 1205 mm. B: 15 mm. C: 460 mm. D: 300 mm.

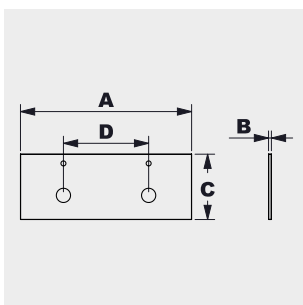

A-DOUBLE  
A-DOBLE

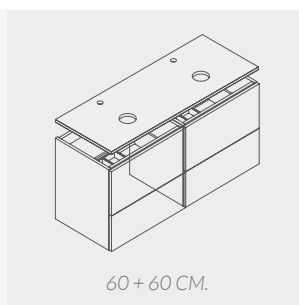

COMPACT COUNTER 2Ø  
COMPACT ENCIMERA 2Ø

CALACATTA STONE Ref. 189502  
POLAR STONE Ref. 196036  
MARQUINA STONE Ref. 189519

MICROTECH COUNTER 2Ø  
MICROTECH ENCIMERA 2Ø

WHITE STONE Ref. 188741

60 + 60 CM.

COMPACT = A: 1205 mm. B: 20 mm. C: 460 mm. D: 600 mm.  
MICROTECH = A: 1205 mm. B: 15 mm. C: 460 mm. D: 600 mm.

STEP 1  
BASE UNIT  
ARMAZÓN

STEP 2  
METAL LEGS  
PATAS METÁLICAS

STEP 3  
HANDLES  
TIRADORES

STEP 4  
COUNTER / ENCIMERA  
BASIN / LAVABO

140 CM COMBINATIONS (56")  
COMBINACIONES 140 (56")

COMPACT COUNTER 1Ø  
COMPACT ENCIMERA 1Ø

CALACATTA STONE Ref. 189076  
POLAR STONE Ref. 196043  
MARQUINA STONE Ref. 189083

MICROTECH COUNTER 1Ø  
MICROTECH ENCIMERA 1Ø

WHITE STONE Ref. 189380

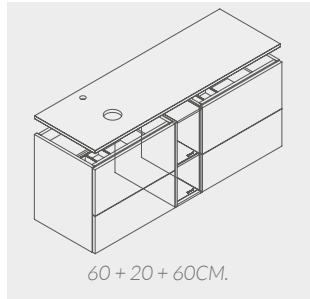

A-LEFT  
A-IZQUIERDA

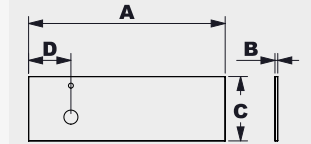

COMPACT = A: 1405 mm. B: 20 mm. C: 460 mm. D: 350 mm.  
MICROTECH = A: 1405 mm. B: 15 mm. C: 460 mm. D: 350 mm.

COMPACT COUNTER 1Ø  
COMPACT ENCIMERA 1Ø

CALACATTA STONE Ref. 189274  
POLAR STONE Ref. 196050  
MARQUINA STONE Ref. 189281

MICROTECH COUNTER 0Ø  
MICROTECH ENCIMERA 0Ø

WHITE STONE Ref. 189465

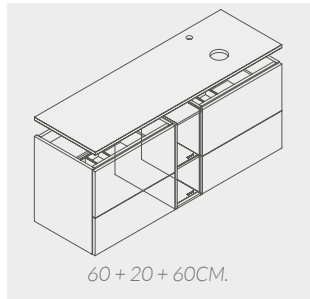

A-RIGHT  
A-DERECHA

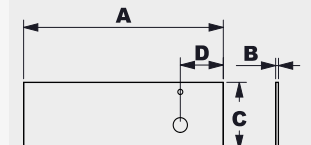

COMPACT = A: 1405 mm. B: 20 mm. C: 460 mm. D: 350 mm.  
MICROTECH = A: 1405 mm. B: 15 mm. C: 460 mm. D: 350 mm.

COMPACT COUNTER DOUBLE 2Ø  
COMPACT ENCIMERA DOBLE 2Ø

CALACATTA STONE Ref. 189090  
POLAR STONE Ref. 196067  
MARQUINA STONE Ref. 189106

MICROTECH COUNTER DOUBLE 2Ø  
MICROTECH ENCIMERA DOBLE 2Ø

WHITE STONE Ref. 189403

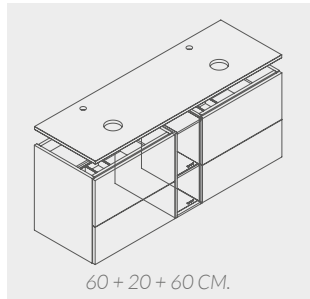

A-DOUBLE  
A-DOBLE

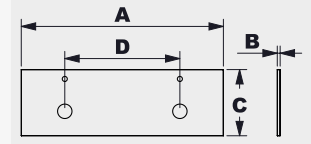

COMPACT = A: 1405 mm. B: 20 mm. C: 460 mm. D: 700 mm.  
MICROTECH = A: 1405 mm. B: 15 mm. C: 460 mm. D: 700 mm.

STEP 1  
BASE UNIT  
ARMAZÓN

STEP 2  
METAL LEGS  
PATAS METÁLICAS

STEP 3  
HANDLES  
TIRADORES

STEP 4  
COUNTER / ENCIMERA  
BASIN / LAVABO

140 CM COMBINATIONS (56")  
COMBINACIONES 140 (56")



COMPACT = A: 1405 mm. B: 20 mm. C: 460 mm. D: 350 mm.  
MICROTECH = A: 1405 mm. B: 15 mm. C: 460 mm. D: 350 mm.

COMPACT COUNTER 1Ø  
COMPACT ENCIMERA 1Ø

CALACATTA STONE Ref. 196081  
POLAR STONE Ref. 196104  
MARQUINA STONE Ref. 196098

MICROTECH COUNTER 1Ø  
MICROTECH ENCIMERA 1Ø

WHITE STONE Ref. 196180



COMPACT = A: 1405 mm. B: 20 mm. C: 460 mm. D: 350 mm.  
MICROTECH = A: 1405 mm. B: 15 mm. C: 460 mm. D: 350 mm.

COMPACT COUNTER 1Ø  
COMPACT ENCIMERA 1Ø

CALACATTA STONE Ref. 196111  
POLAR STONE Ref. 196135  
MARQUINA STONE Ref. 196128

MICROTECH COUNTER 1Ø  
MICROTECH ENCIMERA 1Ø

WHITE STONE Ref. 196197



COMPACT = A: 1405 mm. B: 20 mm. C: 460 mm. D: 700 mm.  
MICROTECH = A: 1405 mm. B: 15 mm. C: 460 mm. D: 700 mm.

COMPACT COUNTER DOUBLE 2Ø  
COMPACT ENCIMERA DOBLE 2Ø

CALACATTA STONE Ref. 189298  
POLAR STONE Ref. 196074  
MARQUINA STONE Ref. 189304

MICROTECH COUNTER DOUBLE 2Ø  
MICROTECH ENCIMERA DOBLE 2Ø

WHITE STONE Ref. 189403



ÉPOQUE





**HUMIDITY RESISTANCE**  
RESISTENTE A LA HUMEDAD



**INSTALLATION NOT REQUIRED**  
SIN INSTALACIÓN



**MAX LOAD CAPACITY**  
CAPACIDAD MÁXIMA



**DOUBLE LAYER PAINT**  
DOBLE CAPA PINTURA



**3/4" (19mm) HDF THICKNESS**  
3/4" 19MM ESPESOR



**SOFT CLOSE HARDWARE**  
CIERRE SUAVE



**CRAFTSMANSHIP**  
HECHO A MANO



**DRAWER ORGANIZER**  
CAJÓN ORGANIZADOR

	ESPECS ESPECIFICACIONES TÉCNICAS	BENEFITS BENEFICIOS
STRUCTURE ESTRUCTURA	<p>Thicknesses throughout the furniture of 19 mm. Particle board. HDF PVC edges 0.8 mm PUR technology (Reactive Polyurethane) Espesores de todo el mueble de 19 mm. Tablero partículas. HDF Cantos PVC 0.8 mm, tecnología PUR (Polyuretano reactivo).</p>	<p>Structure robustness. Humidity resistance. Robustez estructura. Resistente a la humedad.</p>
DRAWERS CAJONES	<p>12 mm ultraslim anthracite metal drawer. Drawer depth 19 mm. Full extraction. Load capacity 30 Kg Organizers included. Regulation and adjustments front. Materials: stainless steel, zamak, aluminium. Fishing technology: Anodized, PVD, electrolyc, thermosetting coating. Cajón metálico antracita ultra slim 12mm. Fondo cajón 19 mm. Extracción total. Capacidad carga 30 Kg. Organizadores incluidos. Regulación y ajuste frentes. Materiales: acero inoxidable, zamak, aluminio. Tecnología acabados: Anodizados, PVD, electrolíticos, recubrimiento termoendurecido.</p>	<p>Design, order and cleanliness. Soft close. Capacity. Wide range of metallic finishes. Resistance and durability. Diseño, orden y limpieza. Suavidad apertura / cierre silencioso. Capacidad. Amplia gama de acabados metálicos. Resistencia y durabilidad.</p>
INSTALLATION INSTALACIÓN	<p>Hangers + wall plate made Italy. Compliance with all regulations and standarts. Drain valves in faucet finishes: chrome, gold, white, black. Patented flexible siphon. Colgadores + placa de pared hecha en Italia. Cumplimiento de todas las normativas y estandares. Válvulas desagüe en acabados grifería: cromo, oro, blanco, negro. Sifón flexible patentado.</p>	<p>Reliability, safety installation. Design and combination with other elements. Maximize drawer space. Reduces costs and facilitates plumbing installation. Fiabilidad, seguridad instalación. Diseño y combinación con el resto de elementos. Maximiza el espacio del cajón. Reduce costes y facilita la instalación de fontanería.</p>
LACQUERED FINISHES ACABADOS LACADOS	<p>Double layed paint on laminated fiber. Soft matte finishes. Doble capa de pintura sobre fibra laminada. Acabados mate soft.</p>	<p>No aging. It looks like the first day. Hardness and resistance lacquered surface. No envejece. Mantiene aspecto como el primer día. Dureza y resistencia de superficies lacadas.</p>
WOOD FINISHES ACABADOS MADERA	<p>Latest technology laminates with synchronized grain. Wide range os finishes. Laminados última tecnología con veta sincronizada. Amplia gama de acabados.</p>	<p>Ultra natural realism. They improve the resistance and properties of the natural veneer. Ultrarealismo natural. Mejoran la resistencia y las propiedades de la chapa natural.</p>
BASINS LAVABOS	<p>See features / washbasin range. Ver características / gama lavabos.</p>	

# ÉPOQUE

THE BEAUTY OF ART DECO



## BASE UNIT MUEBLE

60cm  
80cm  
100cm

## FINISHES ACABADOS



BLANCO SOFT



STORM GREY SOFT



NAVY



LIGHT OAK

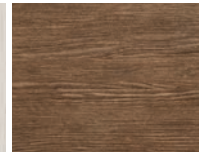

NUT OAK

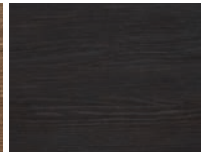

NIGHT OAK



## BASIN LAVABOS

60cm  
80cm  
100cm

## FINISHES ACABADOS



MINERAL GLOSS



MINERAL MATT



## HANDLES TIRADORES

## FINISHES ACABADOS



WHITE



BRUSHED GOLD



BRUSHED NICKEL



CHROME



BLACK

ÉPOQUE

---







# ÉPOQUE

---



ÉPOQUE

---



# ÉPOQUE

---





# ÉPOQUE

---



ÉPOQUE

---



# ÉPOQUE

CREATE YOUR ÉPOQUE  
CREA TU ÉPOQUE

STEP 1  
SELECT THE BASE UNIT  
SELECCIONA EL ARMAZÓN

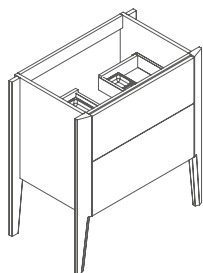

60 CM | 80 CM | 100 CM  
24" | 32" | 40"

STEP 2  
SELECT THE BASIN  
SELECCIONA EL LAVABO

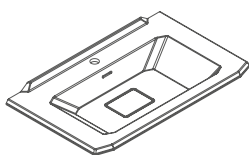

60 CM | 80 CM | 100 CM  
24" | 32" | 40"

STEP 3  
SELECT THE SET OF HANDLES  
SELECCIONA EL TIRADOR

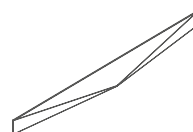

BRUSHED NICKEL | BRUSHED GOLD  
CHROME | WHITE | BLACK

COMPLETE YOUR INSTALLATION  
COMPLETA TU INSTALACIÓN



**POP UP**  
PUSH DOWN  
Ø 37 mm. 1 ¼"  
VÁLVULA CLICKER  
Ø 37 mm. 1 ¼"  
CHROME / CROMO  
Ref. 157051



**PRELOC**  
WASTE P-TRAP 1 ¼"  
SIFÓN DESAGÜE 1 ¼"  
WHITE / BLANCO  
Ref. 188291





## STEP 1 | PASO 1

SELECT THE BASE UNIT  
SELECCIONA EL ARMAZÓN

### BASE UNIT 60 (24") ARMAZÓN 60 (24")

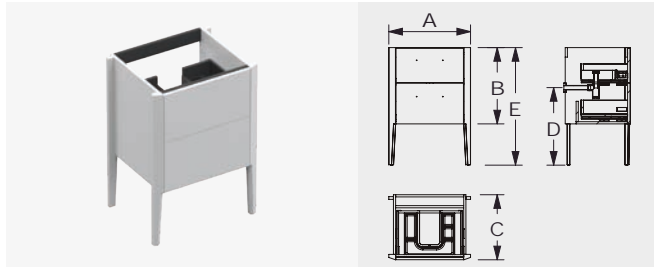

BLANCO SOFT  
STORM GREY SOFT  
NAVY  
NUT OAK  
NIGHT OAK  
LIGHT OAK

Ref. 180332  
Ref. 180325  
Ref. 181063  
Ref. 180356  
Ref. 180349  
Ref. 180318

A: 600 mm. B: 560 mm. C: 478 mm.  
D: 570-620 E: 863 mm.

### BASE UNIT 80 (32") ARMAZÓN 80 (32")

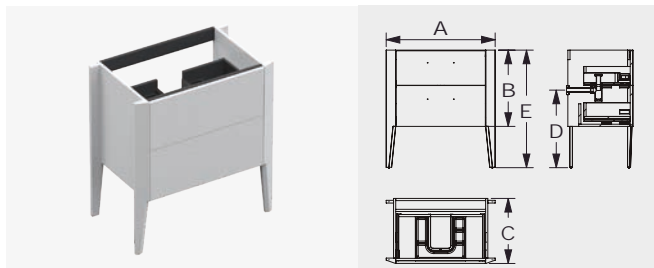

BLANCO SOFT  
STORM GREY SOFT  
NAVY  
NUT OAK  
NIGHT OAK  
LIGHT OAK

Ref. 180363  
Ref. 180387  
Ref. 181070  
Ref. 180400  
Ref. 180394  
Ref. 180370

A: 800 mm. B: 560 mm. C: 478 mm.  
D: 570-620 E: 863 mm.

### BASE UNIT 100 (40") ARMAZÓN 100 (40")

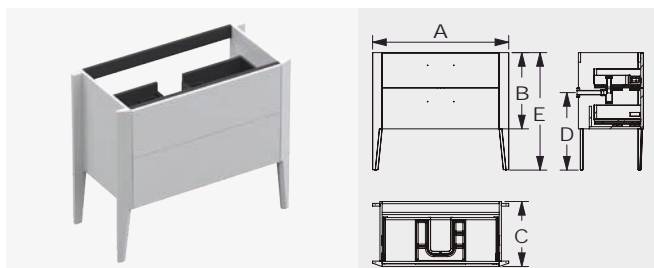

BLANCO SOFT  
STORM GREY SOFT  
NAVY  
NUT OAK  
NIGHT OAK  
LIGHT OAK

Ref. 180417  
Ref. 180455  
Ref. 181087  
Ref. 180448  
Ref. 180431  
Ref. 180424

A: 1000 mm. B: 560 mm. C: 478 mm.  
D: 570-620 E: 863 mm.

## STEP 2 | PASO 2

SELECT THE BASIN  
SELECCIONA EL LAVABO

### MX8 BASIN 60 1Ø (24") MX8 ENCIMERA 60 1Ø (24")

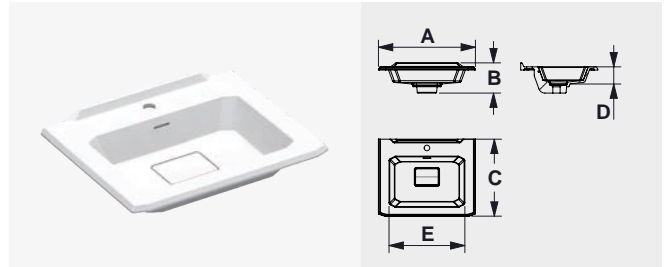

MINERAL GLOSS  
MINERAL MATT

Ref. 180561  
Ref. 180578

A: 610 mm. B: 166 mm.  
C: 485 mm. D: 96 mm.

### MX8 BASIN 80 1Ø (32") MX8 ENCIMERA 80 1Ø (32")

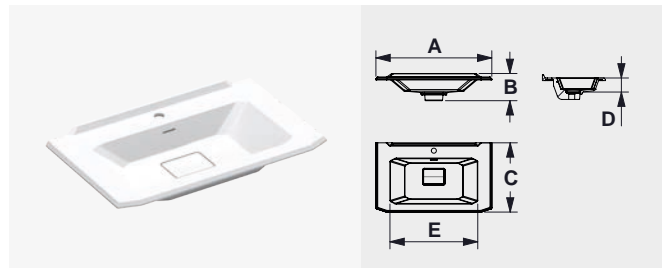

MINERAL GLOSS  
MINERAL MATT

Ref. 180585  
Ref. 180592

A: 810 mm. B: 166 mm.  
C: 485 mm. D: 96 mm.

### MX8 BASIN 100 1Ø (40") MX8 ENCIMERA 100 1Ø (40")

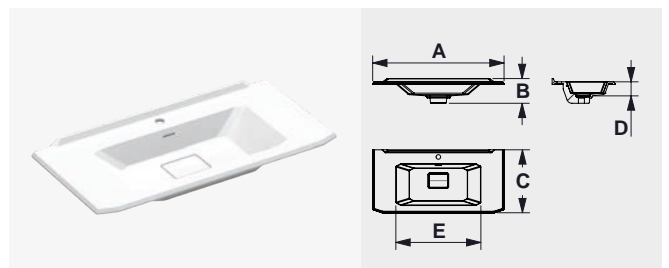

MINERAL GLOSS  
MINERAL MATT

Ref. 180615  
Ref. 180608

A: 1010 mm. B: 166 mm.  
C: 485 mm. D: 96 mm.

# ÉPOQUE

---



## FINISH OPTIONS OPCIONES DE ACABADOS

---



LIGHT OAK  
Ref. 9992225K



NUT OAK  
Ref. 9992225J

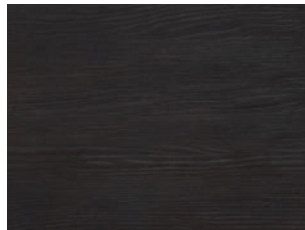

NIGHT OAK  
Ref. 9992225L



BLANCO SOFT  
Ref. 9992224O



STORM GREY SOFT  
Ref. 9992225I



NAVY  
Ref. 9992225H

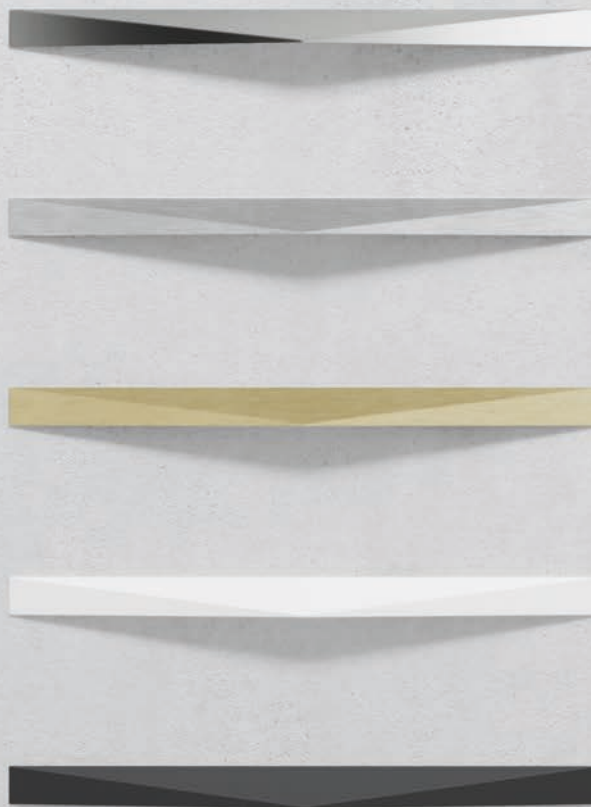

STEP 3 | PASO 3  
**SELECT THE SET OF HANDLES**  
**SELECCIONA EL TIRADOR**

**ÉPOQUE SET HANDLE**  
**ÉPOQUE SET DE TIRADORES**

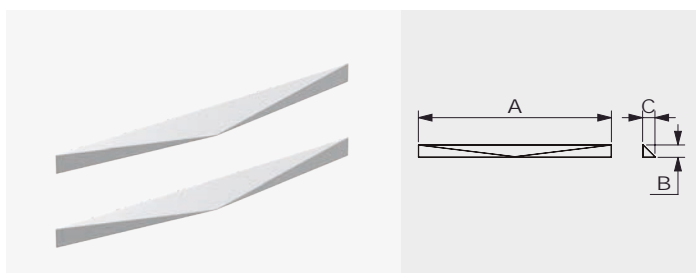

CHROME  
 BRUSHED NICKEL  
 BRUSHED GOLD  
 WHITE  
 BLACK

Ref. 181162  
 Ref. 181179  
 Ref. 181254  
 Ref. 181247  
 Ref. 181278

A: 312 mm. B: 20 mm. C: 20 mm.



CHROME

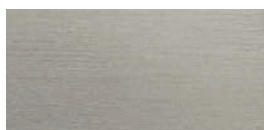

BRUSHED NICKEL



BRUSHED GOLD



WHITE



BLACK

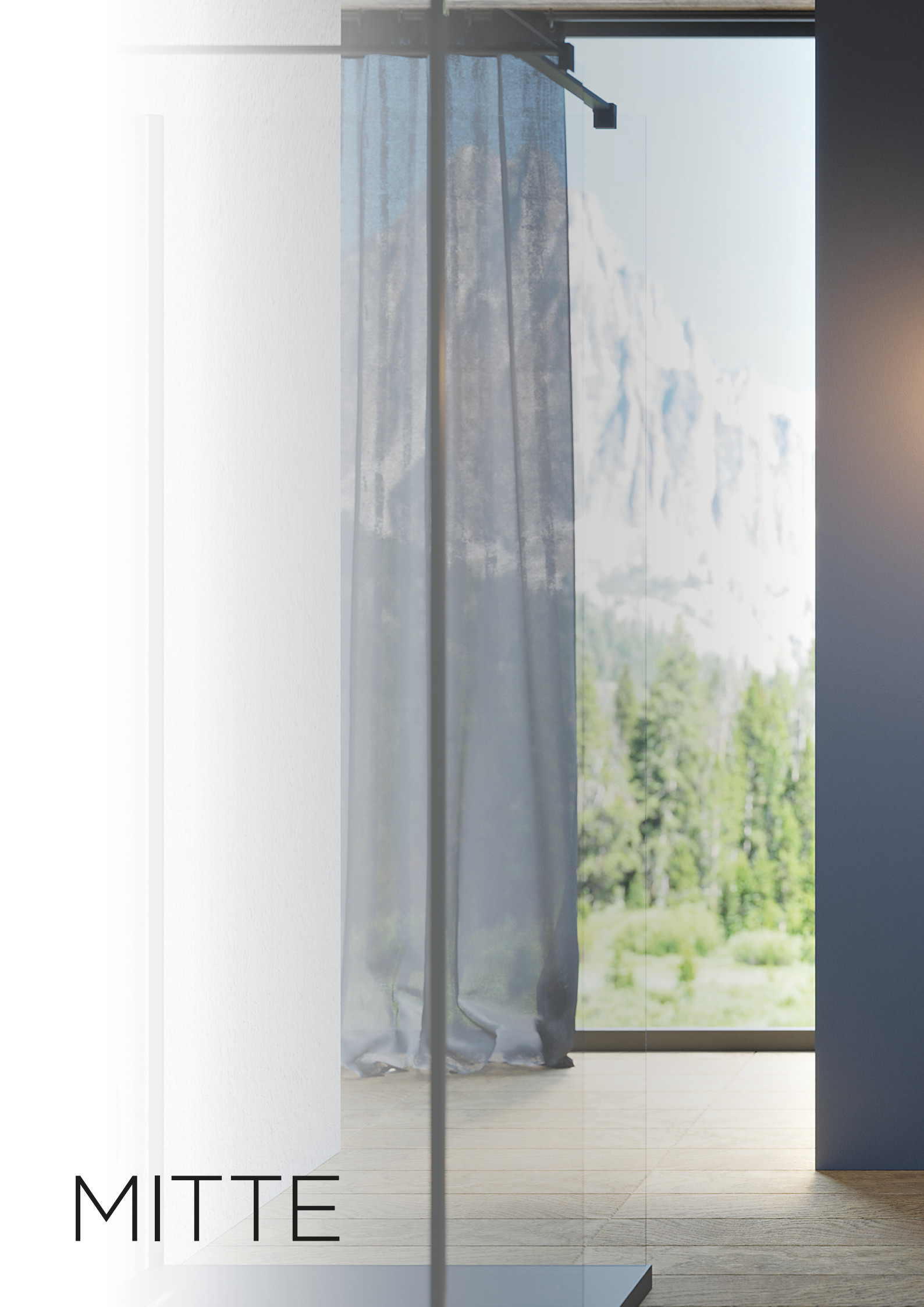

MITTE





**HUMIDITY RESISTANCE**  
RESISTENTE A LA HUMEDAD



**INSTALLATION NOT REQUIRED**  
SIN INSTALACIÓN



**MAX LOAD CAPACITY**  
CAPACIDAD MÁXIMA



**DOUBLE LAYER PAINT**  
DOBLE CAPA PINTURA



**3/4" (19mm) HDF THICKNESS**  
3/4" 19MM ESPESOR



**SOFT CLOSE HARDWARE**  
CIERRE SUAVE



**CRAFTSMANSHIP**  
HECHO A MANO



**DRAWER ORGANIZER**  
CAJÓN ORGANIZADOR

	SPECS ESPECIFICACIONES TÉCNICAS	BENEFITS BENEFICIOS
STRUCTURE ESTRUCTURA	<p>Thicknesses throughout the furniture of 19 mm. Particle board. HDF PVC edges 0.8 mm PUR technology (Reactive Polyurethane) Espesores de todo el mueble de 19 mm. Tablero partículas. HDF Cantos PVC 0.8 mm, tecnología PUR (Polyuretano reactivo).</p>	<p>Structure robustness. Humidity resistance. Estructura robusta. Resistente a la humedad.</p>
DRAWERS CAJONES	<p>12 mm ultraslim anthracite metal drawer. Drawer depth 19 mm. Full extraction. Load capacity 30 Kg Organizers included. Regulation and adjustments front. Cajón metálico antracita ultra slim 12mm. Fondo cajón 19 mm. Extracción total. Capacidad carga 30 Kg. Organizadores incluidos. Regulación y ajuste frentes.</p>	<p>Design, order and cleanliness. Soft close. Capacity. Diseño, orden y limpieza. Suavidad apertura / cierre silencioso. Capacidad.</p>
METAL FRAME ESTRUCTURA	<p>Metal aluminum frame structure 25x25mm square profile. Levelers in 4 legs. Estructura en perfiles cuadrada de aluminio 25x25mm. Niveladores en las 4 patas.</p>	<p>Improve the functionality with the accessories. Aumentar la funcionalidad con los accesorios.</p>
INSTALLATION INSTALACIÓN	<p>Hangers + wall plate made Italy. Compliance with all regulations and standards. Drain valves in faucet finishes: chrome, gold, white, black. Patented flexible siphon. Colgadores + placa de pared hecha en Italia. Cumplimiento de todas las normativas y estándares. Válvulas desagüe en acabados grifería: cromo, oro, blanco, negro. Sifón flexible patentado.</p>	<p>Reliability, safety installation. Design and combination with other elements. Maximize drawer space. Reduces costs and facilitates plumbing installation. Fiabilidad, seguridad instalación. Diseño y combinación con el resto de elementos. Maximiza el espacio del cajón. Reduce costes y facilita la instalación de fontanería.</p>
LACQUERED FINISHES ACABADOS LACADOS	<p>Double layered paint on laminated fiber. Gloss finishes. Doble capa de pintura sobre fibra laminada. Acabados brillo.</p>	<p>No aging. It looks like the first day. Hardness and resistance lacquered surface. No envejece. Mantiene aspecto como el primer día. Dureza y resistencia de superficies lacadas.</p>
WOOD FINISHES ACABADOS MADERA	<p>Latest technology laminates with synchronized grain. Laminados última tecnología con veta sincronizada.</p>	<p>Ultra natural realism. They improve the resistance and properties of the natural veneer. Ultrarealismo natural. Mejoran la resistencia y las propiedades de la chapa natural.</p>

# MITTE

NOT INDIFFERENT

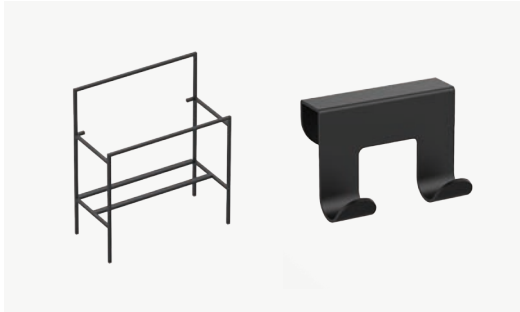

## METAL FRAME + COMPLEMENTS ESTRUCTURA + ACCESORIOS

95cm  
115cm

## FINISHES ACABADOS



BLANCO



NEGRO



## BASE UNIT ARMAZÓN

80cm  
100cm

## FINISHES ACABADOS



SNOW WOOD



RAW WOOD



SAND WOOD

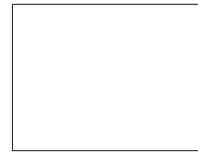

BLANCO GLOSS



TORTORA GLOSS



## BASIN LAVABO

MX10

## FINISHES ACABADOS



MINERAL GLOSS



MINERAL MATT



## COUNTER + BASIN ENCIMERA + LAVABO

80cm  
100cm

## FINISHES ACABADOS



WHITE STONE



TORTORA STONE



DARK GREY STONE



SX12



WHITE STONE



TORTORA STONE



DARK GREY STONE

MITTE







MITTE

---



MITTE

---



# MITTE

---





MITTE

---



MITTE

---



# MITTE

CREATE YOUR MITTE  
CREA TU MITTE

## STEP 1

**SELECT THE METAL FRAME**  
- Size  
- Version

**SELECCIONA LA ESTRUCTURA**  
- Tamaño  
- Versión

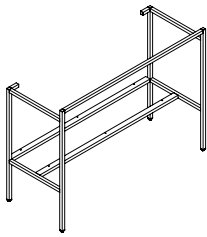

95 CM (37")  
115 CM (45")

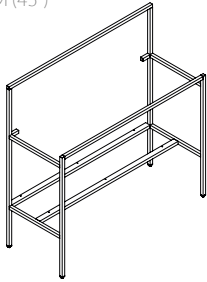

XL 95 CM (37")  
XL 115 CM (45")

## STEP 2

**SELECT THE CABINET**

**SELECCIONA EL ARMAZÓN**

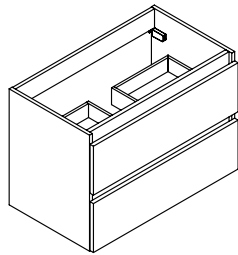

80 CM (31")

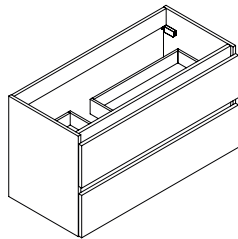

100 CM (39")

## STEP 3

**SELECT THE BASIN**  
- Basin  
- Counter & basin

**SELECCIONA EL LAVABO**  
- Lavabo  
- Encimera & lavabo

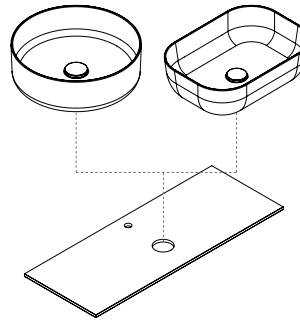
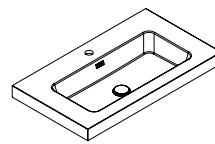

## STEP 4

**SELECT ACCESSORIES TO GET EXTRA FUNCTIONALITY**

**SELECCIONA ACCESORIOS PARA AÑADIR FUNCIONALIDAD EXTRA**

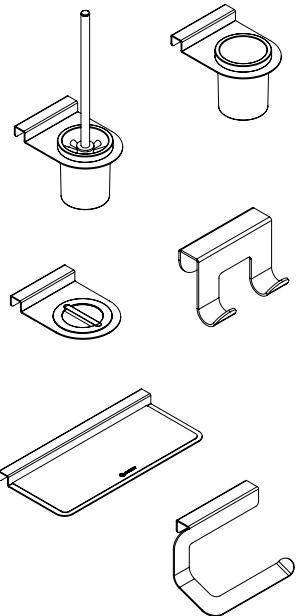

## CABINET FINISH OPTIONS OPCIONES DE ACABADOS MUEBLE



SNOW WOOD  
Ref. 9992226E

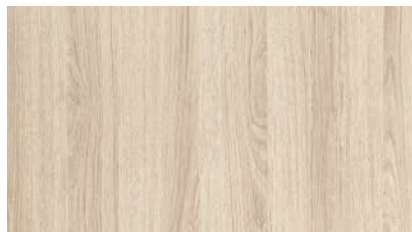

RAW WOOD  
Ref. 9992226D

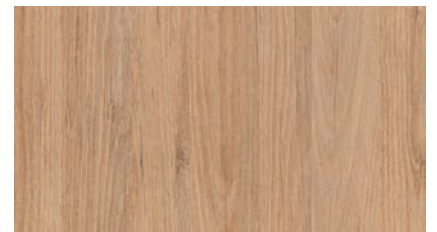

SAND WOOD  
Ref. 9992226C

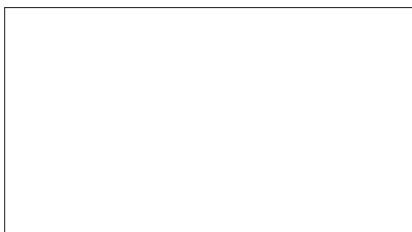

BLANCO GLOSS  
Ref. 9992225O



TORTORA GLOSS  
Ref. 9992226F



## STEP 1 - SELECT THE METAL FRAME PASO 1 - SELECCIONA LA ESTRUCTURA

### METAL FRAME 95 (37") ESTRUCTURA 95 (37")

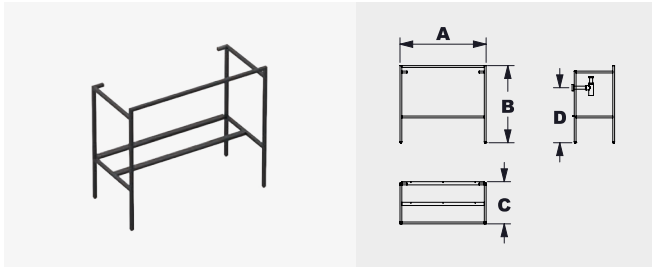

WHITE  
BLACK

Ref. 186648  
Ref. 186600

A: 950 mm. B: 840 mm.  
C: 460 mm. D: 570-620 mm.

### METAL FRAME 115 (45") ESTRUCTURA 115 (45")

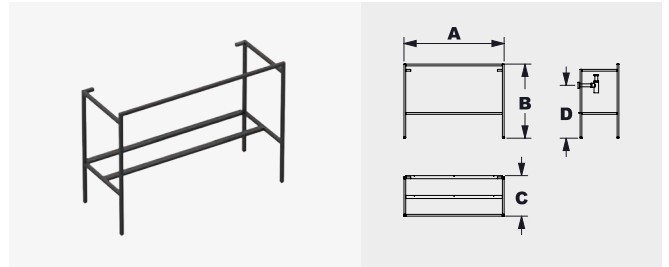

WHITE  
BLACK

Ref. 186662  
Ref. 186624

A: 1150 mm. B: 840 mm.  
C: 460 mm. D: 570-620 mm.

### XL-METAL FRAME 95 (37") ESTRUCTURA-XL 95 (37")

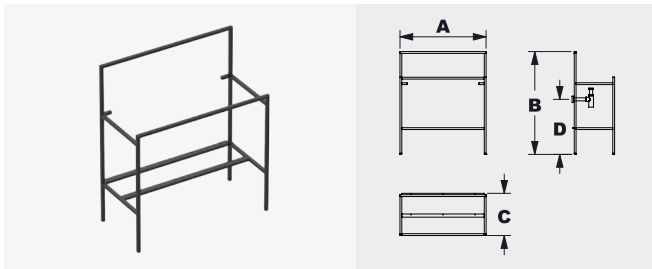

WHITE  
BLACK

Ref. 186655  
Ref. 186617

A: 950 mm. B: 1120 mm.  
C: 460 mm. D: 570-620 mm.

### XL-METAL FRAME 115 (45") ESTRUCTURA-XL 115 (45")

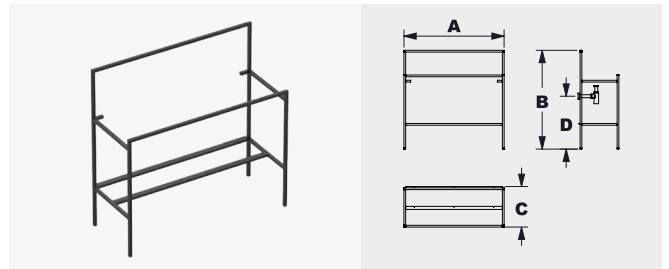

WHITE  
BLACK

Ref. 186679  
Ref. 186631

A: 1150 mm. B: 1120 mm.  
C: 460 mm. D: 570-620 mm.

## STEP 2 - SELECT THE CABINET PASO 2 - SELECCIONA EL ARMAZÓN

### BASE UNIT 80 (32") ARMAZÓN 80 (32")

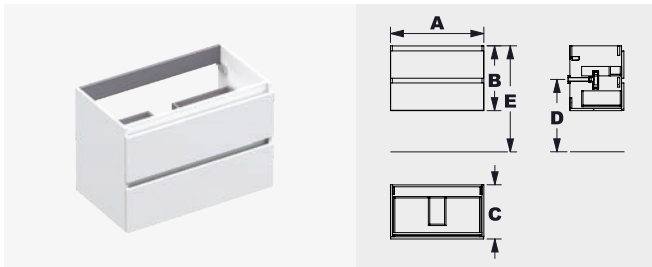

BLANCO GLOSS  
TORTORA GLOSS  
SNOW WOOD  
RAW WOOD  
SAND WOOD

Ref. 186686  
Ref. 186693  
Ref. 186716  
Ref. 186723  
Ref. 186730

A: 795 mm. B: 550 mm. C: 460 mm.  
D: 560-610 mm. E: 900 mm.

### BASE UNIT 100 (40") ARMAZÓN 100 (40")

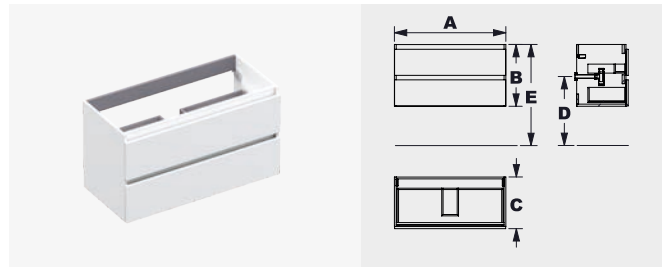

BLANCO GLOSS  
TORTORA GLOSS  
SNOW WOOD  
RAW WOOD  
SAND WOOD

Ref. 186747  
Ref. 186754  
Ref. 186778  
Ref. 186785  
Ref. 186792

A: 995 mm. B: 550 mm. C: 460 mm.  
D: 560-610 mm. E: 900 mm.



## COMPLETE YOUR INSTALLATION COMPLETA TU INSTALACIÓN

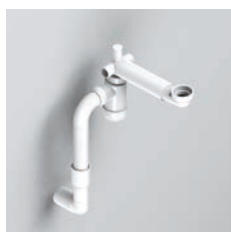

**PRELOC**  
TRAP 1 1/4"  
SIFÓN 1 1/4"  
Compatible for counter SX12 basins.  
Compatible con lavabos sobre encimera SX12

BLANC / WIT  
Ref. 188291



**CLICKER**  
PUSH DOWN  
Ø 65 mm. 1 1/4"  
VÁLVULA CLICKER  
Ø 65 mm. 1 1/4"

CHROME Ref. 123940  
WHITE Ref. 188895  
TORTORA Ref. 188901  
DARK GREY Ref. 188918

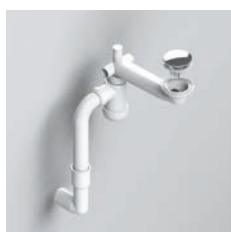

**PRELOC + CLICKER**  
TRAP 1 1/4"  
SIFÓN 1 1/4"  
Compatible for MX10 basins  
Compatible con lavabos MX10

CLICKER CHROME Ref. 161508  
CLICKER WHITE Ref. 190102

## STEP 3 - SELECT THE BASIN + COUNTER OR BASIN PASO 3 - SELECCIONA LA ENCIMERA O LAVABO + ENCIMERA PLANA

### SX12 BASIN CERAMIC 44x32 (17x12") SX12 LAVABO CERÁMICA 44x32

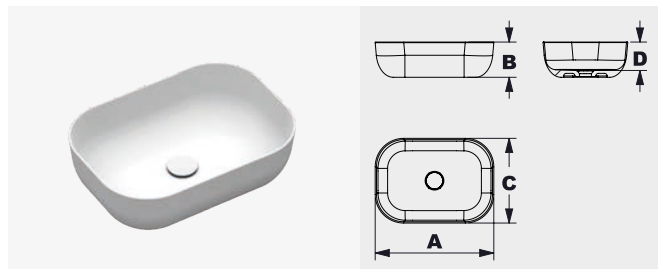

WHITE MATT  
TORTORA MATT  
DARK GREY MATT

Ref. 187362  
Ref. 187379  
Ref. 187386

A: 455 mm. B: 135 mm.  
C: 325 mm. D: 109 mm.

### SX12 BASIN CERAMIC Ø15 SX12 LAVABO CERÁMICA Ø15

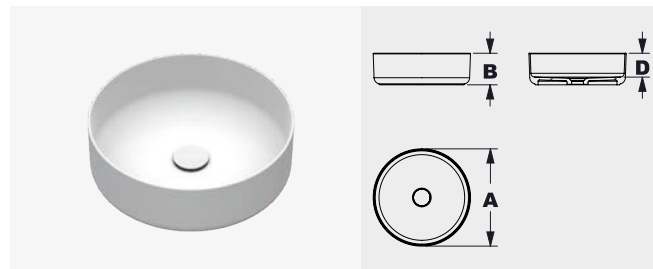

WHITE MATT  
TORTORA MATT  
DARK GREY MATT

Ref. 187331  
Ref. 187348  
Ref. 187355

A: 370 mm. B: 120 mm. D: 91 mm.

### MICROTECH COUNTER 80 1Ø (32") MICROTECH ENCIMERA 80 1Ø (32")

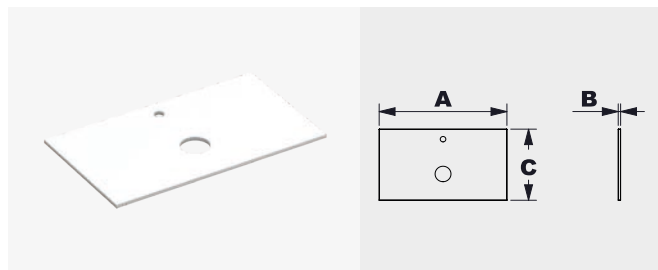

WHITE STONE  
TORTORA STONE  
DARK GREY STONE

Ref. 187393  
Ref. 187416  
Ref. 187430

A: 805 mm. B: 15 mm. C: 460 mm.

### MICROTECH COUNTER 100 1Ø (40") MICROTECH ENCIMERA 100 1Ø (40")

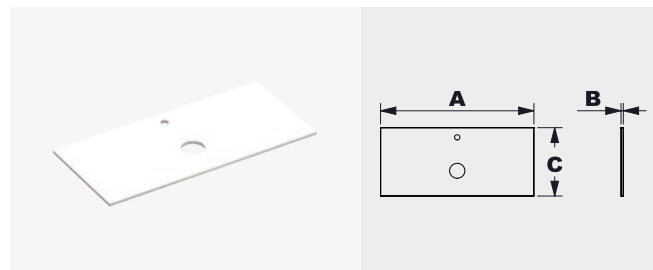

WHITE STONE  
TORTORA STONE  
DARK GREY STONE

Ref. 187409  
Ref. 187423  
Ref. 187447

A: 1005 mm. B: 15 mm. C: 460 mm.

### MX10 BASIN 80 1Ø (32") MX10 ENCIMERA 80 1Ø (32")

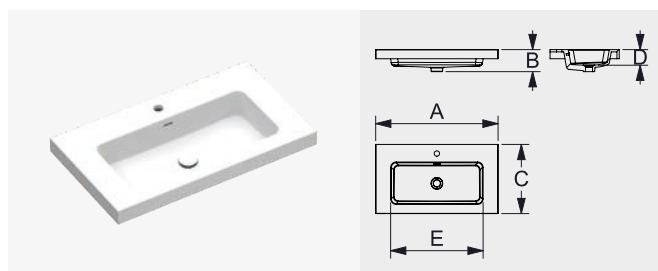

MINERAL MATT  
MINERAL GLOSS

Ref. 186907  
Ref. 186914

A: 805 mm. B: 145 mm. C: 455 mm.  
D: 100 mm. E: 600 mm.

### MX10 BASIN 100 1Ø (40") MX10 ENCIMERA 100 1Ø (40")

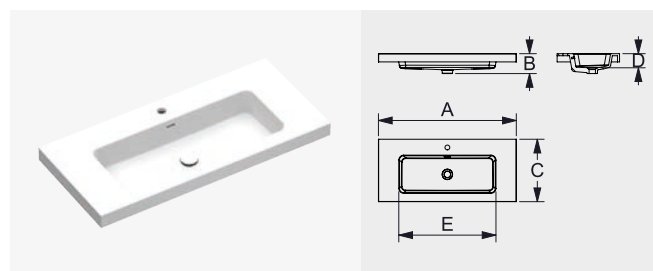

MINERAL MATT  
MINERAL GLOSS

Ref. 186921  
Ref. 186938

A: 1005 mm. B: 145 mm. C: 455 mm.  
D: 100 mm. E: 700 mm.

## FINISH OPTIONS OPCIONES DE ACABADOS

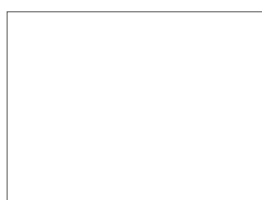

WHITE STONE



DARK GREY STONE



TORTORA STONE

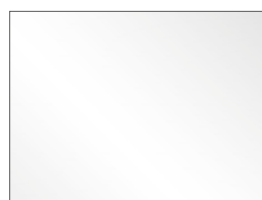

MINERAL GLOSS

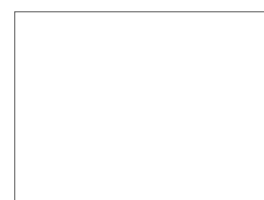

MINERAL MATT

# MITTE

---



## STEP 4 - ACCESSORIES PASO 4 - ACCESORIOS

---



HAIR STRAIGHTENER HOLDER  
SOPORTE PLANCHA

BLACK  
A: 120 mm, B: 25 mm, C: 163 mm.

Ref. 186846



HAIR DRYER HOLDER  
SOPORTE SECADOR

BLACK  
A: 120 mm, B: 25 mm, C: 163 mm.

Ref. 186839



DOUBLE ROBE HOOK  
PERCHA DOBLE

BLACK  
A: 90 mm, B: 65 mm, C: 51 mm.

Ref. 177011



**SHELF 350 MM (14")**  
**REPISA 350 MM**

BLACK  
A: 350 mm, B: 22 mm, C: 163 mm.

Ref. 186808



**TUMBLER HOLDER**  
**PORTAVASOS**

BLACK  
A: 120 mm, B: 118 mm, C: 163 mm.

Ref. 186815



**TOILET ROLL HOLDER**  
**PORTARROLLOS**

BLACK  
A: 159 mm, B: 104 mm, C: 98 mm.

Ref. 176939



**WC BRUSH SET**  
**ESCOBILLERO**

BLACK  
A: 120 mm, B: 363 mm, C: 163 mm.

Ref. 186822

# MITTE

---



## STEP 4 - ACCESSORIES PASO 4 - ACCESORIOS

---



**HAIR STRAIGHTENER HOLDER**  
SOPORTE PLANCHA

WHITE  
A: 120 mm, B: 25 mm, C: 163 mm.

Ref. 186891



**HAIR DRYER HOLDER**  
SOPORTE SECADOR

WHITE  
A: 120 mm, B: 25 mm, C: 163 mm.

Ref. 186884



**DOUBLE ROBE HOOK**  
PERCHA DOBLE

WHITE  
A: 90 mm, B: 65 mm, C: 51 mm.

Ref. 177004



**SHELF 350 MM (14")**  
**REPISA 350 MM**

WHITE  
A: 350 mm, B: 22 mm, C: 163 mm.

Ref. 186853



**TUMBLER HOLDER**  
**PORTAVASOS**

WHITE  
A: 120 mm, B: 118 mm, C: 163 mm.

Ref. 186860



**TOILET ROLL HOLDER**  
**PORTARROLLOS**

WHITE  
A: 159 mm, B: 104 mm, C: 98 mm.

Ref. 176946



**WC BRUSH SET**  
**ESCOBILLERO**

WHITE  
A: 120 mm, B: 363 mm, C: 163 mm.

Ref. 186877



PLAY







**HUMIDITY RESISTANCE**  
RESISTENTE A LA HUMEDAD



**INSTALLATION TO THE WALL**  
INSTALACIÓN A PARED



**MAX LOAD CAPACITY**  
CAPACIDAD MÁXIMA



**DOUBLE LAYER PAINT**  
DOBLE CAPA PINTURA



**3/4" (19mm) HDF THICKNESS**  
3/4" 19MM ESPESOR



**SOFT CLOSE HARDWARE**  
CIERRE SUAVE



**CRAFTSMANSHIP**  
HECHO A MANO



**DRAWER ORGANIZER**  
CAJÓN ORGANIZADOR

	SPECS ESPECIFICACIONES TÉCNICAS	BENEFITS BENEFICIOS
STRUCTURE ESTRUCTURA	<p>Thicknesses throughout the furniture of 19 mm. Particle board. HDF PVC edges 0.8 mm PUR technology (Reactive Polyurethane) Espesores de todo el mueble de 19 mm. Tablero partículas. HDF Cantos PVC 0.8 mm, tecnología PUR (Polyuretano reactivo).</p>	<p>Structure robustness. Humidity resistance. Estructura robusta. Resistente a la humedad.</p>
DRAWERS CAJONES	<p>12 mm ultraslim anthracite metal drawer. Drawer depth 19 mm. Full extraction. Load capacity 30 Kg Organizers included. Regulation and adjustments front. Cajón metálico antracita ultra slim 12mm. Fondo cajón 19 mm. Extracción total. Capacidad carga 30 Kg. Organizadores incluidos. Regulación y ajuste frentes.</p>	<p>Design, order and cleanliness. Soft close. Capacity. Diseño, orden y limpieza. Suavidad apertura / cierre silencioso. Capacidad.</p>
HANDLES TIRADORES	<p>Materials: stainless steel, zamak, aluminium. Fishing technology: Anodized, PVD, electrolyc, thermosetting coating. Materiales: acero inoxidable, zamak, aluminio. Tecnología acabados: Anodizados, PVD, electrolíticos, recubrimiento termoendurecido.</p>	<p>Wide range of metallic finishes. Resistance and durability. Amplia gama de acabados metálicos. Resistencia y durabilidad.</p>
INSTALLATION INSTALACIÓN	<p>Hangers + wall plate made Italy. Compliance with all regulations and standarts. Drain valves in faucet finishes: chrome, gold, white, black. Patented flexible siphon. Colgadores + placa de pared hecha en Italia. Cumplimiento de todas las normativas y estandares. Válvulas desagüe en acabados grifería: cromo, oro, blanco, negro. Sifón flexible patentado.</p>	<p>Reliability, safety installation. Design and combination with other elements. Maximize drawer space. Reduces costs and facilitates plumbing installation. Fiabilidad, seguridad instalación. Diseño y combinación con el resto de elementos. Maximiza el espacio del cajón. Reduce costes y facilita la instalación de fontanería.</p>
LACQUERED FINISHES ACABADOS LACADOS	<p>Double layed paint on laminated fiber. Soft matte finishes. Doble capa de pintura sobre fibra laminada. Acabados mate soft.</p>	<p>No aging. It looks like the first day. Hardness and resistance lacquered surface. No envejece. Mantiene aspecto como el primer día. Dureza y resistencia de superficies lacadas.</p>
WOOD FINISHES ACABADOS MADERA	<p>Latest technology laminates with synchronized grain. Laminados última tecnología con veta sincronizada.</p>	<p>Ultra natural realism. They improve the resistance and properties of the natural veneer. Ultrarealismo natural. Mejoran la resistencia y las propiedades de la chapa natural.</p>

# PLAY

CONTEMPORARY NEOCLASSIC



**BASE UNIT  
MUEBLE**

**FINISHES  
ACABADOS**

80cm  
100cm



OAKWOOD



TOBACCO WOOD



BLANCO SOFT



STORM GREY SOFT



**BASIN  
LAVABO**

**FINISHES  
ACABADOS**

MX1  
MX3  
SX7

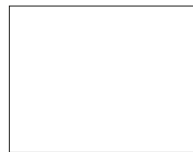

MINERAL MARMO



MINERAL SOLID



CERAMIC



**WALL VITRINE  
COLUMNNA**

**FINISHES  
ACABADOS**

160cm

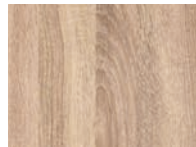

OAKWOOD

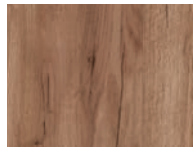

TOBACCO WOOD



BLANCO SOFT



STORM GREY SOFT



**HANDLES  
TIRADORES**

**FINISHES  
ACABADOS**



WHITE



BRUSHED GOLD



BRUSHED NICKEL



CHROME



BLACK

PLAY

---





PLAY

---









PLAY



# PLAY

CREATE YOUR PLAY  
CREA TU PLAY

STEP 1  
SELECT THE BASE UNIT  
SELECCIONA EL ARMAZÓN

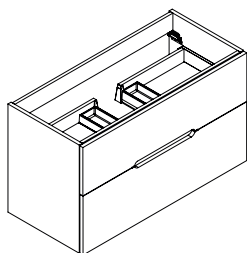

80 CM | 100 CM  
32" | 40"

STEP 2  
SELECT THE BASIN  
SELECCIONA EL LAVABO

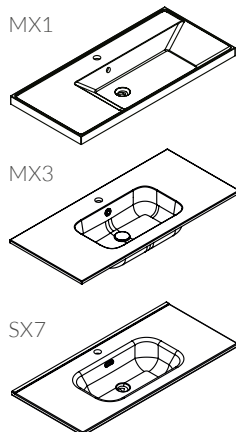

80 CM | 100 CM  
32" | 40"

STEP 3  
SELECT THE WALL VITRINE  
SELECCIONA LA COLUMNA

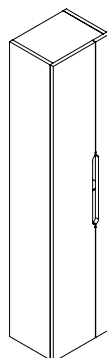

STEP 4  
SELECT THE SET OF HANDLES  
SELECCIONA LOS TIRADORES

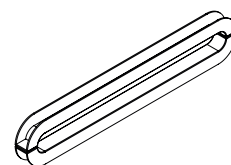

BRUSHED NICKEL  
BRUSHED GOLD  
CHROME | WHITE | BLACK

STEP 1 - SELECT THE BASE UNIT  
STEP 1 - SELECCIONA EL ARMAZÓN

BASE UNIT 80 (32")  
ARMAZÓN 80 (32")

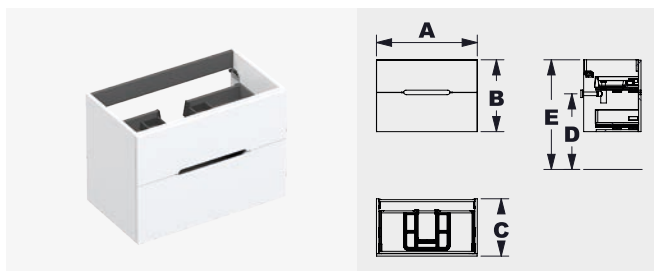

BLANCO SOFT  
STORM GREY SOFT  
OAKWOOD  
TOBACCO WOOD

Ref. 186952 A: 800 mm. B: 570 mm. C: 458 mm.  
Ref. 186969 D: 650 mm. E: 890 mm.  
Ref. 186976  
Ref. 187737

BASE UNIT 100 (40")  
ARMAZÓN 100 (40")

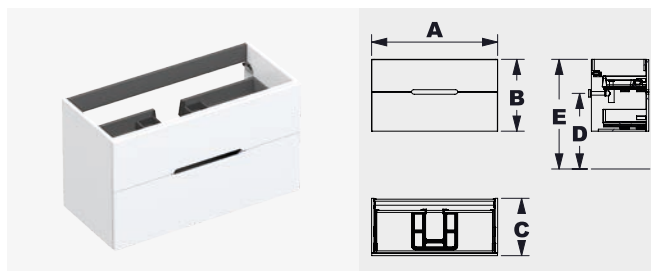

BLANCO SOFT  
STORM GREY SOFT  
OAKWOOD  
TOBACCO WOOD

Ref. 186983 A: 1000 mm. B: 570 mm. C: 458 mm.  
Ref. 186990 D: 650 mm. E: 890 mm.  
Ref. 187003  
Ref. 187744

FINISH OPTIONS  
OPCIONES DE ACABADOS



BLANCO SOFT  
Ref. 9992224O



STORM GREY SOFT  
Ref. 9992226G

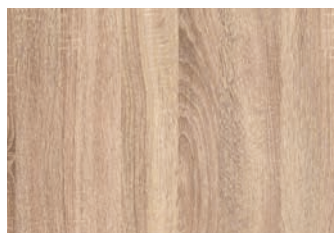

OAK WOOD  
Ref. 9992225G

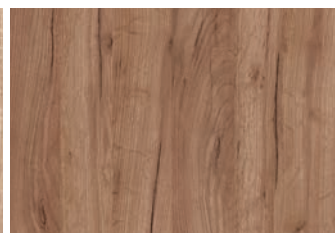

TOBACCO WOOD  
Ref. 9992226A

STEP 2 - SELECT THE BASIN  
STEP 2 - SELECCIONA EL LAVABO

**MX1 BASIN 80 1Ø (32")**  
**MX1 ENCIMERA 80 1Ø (32")**

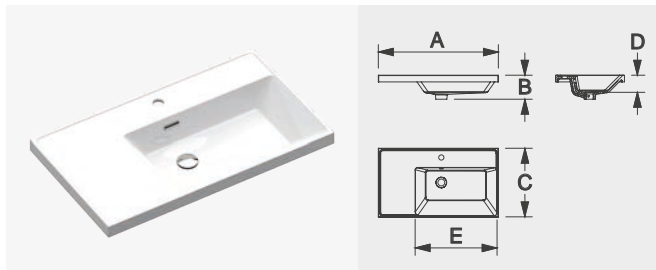

MINERAL MARMO®

Ref. 161171

A: 806 mm. B: 161 mm. C: 463 mm.  
D: 115 mm. E: 546 mm.  
Available with ØØ Disponible en ØØ.

**MX1 BASIN 100 1Ø (40")**  
**MX1 ENCIMERA 100 1Ø (40")**

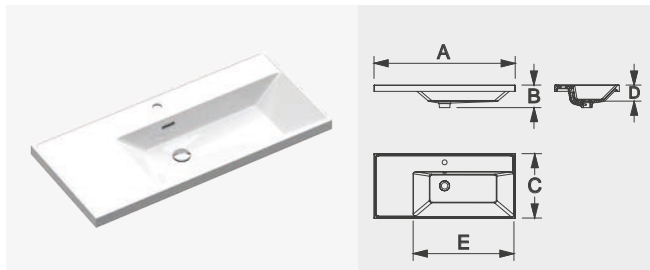

MINERAL MARMO®

Ref. 161188

A: 1006 mm. B: 161 mm. C: 463 mm.  
D: 115 mm. E: 718 mm.  
Available with ØØ Disponible en ØØ.

**MX3 BASIN 80 1Ø (32")**  
**MX3 ENCIMERA 80 1Ø (32")**

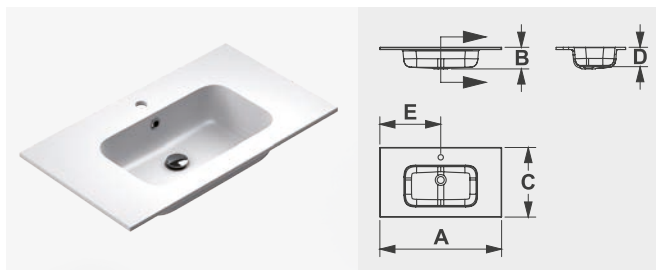

MINERAL SOLID®

Ref. 168873

A: 805 mm. B: 143 mm. C: 460 mm.  
D: 128 mm. E: 400 mm.

**MX3 BASIN 100 1Ø (40")**  
**MX3 ENCIMERA 100 1Ø (40")**

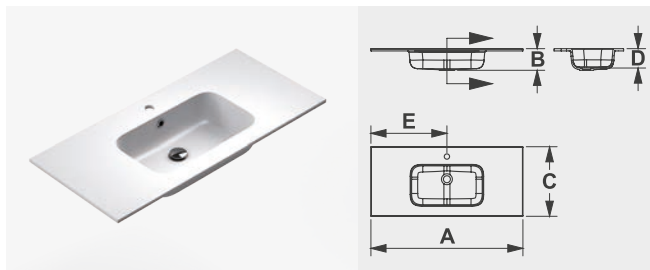

MINERAL SOLID®

Ref. 168897

A: 1005 mm. B: 143 mm. C: 460 mm.  
D: 128 mm. E: 500 mm.

**SX7 BASIN 80 1Ø (32")**  
**SX7 ENCIMERA 80 1Ø (32")**

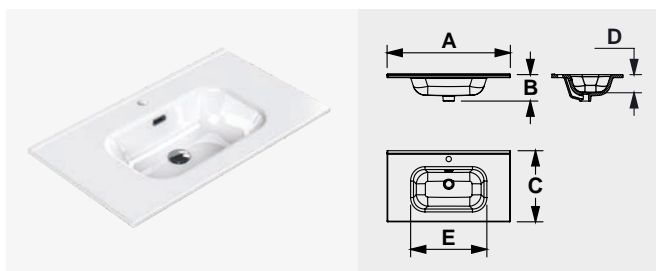

CERAMIC / CERÁMICA

Ref. 161423

A: 815 mm. B: 175 mm. C: 465 mm.  
D: 120 mm. E: 500 mm.

**SX7 BASIN 100 1Ø (40")**  
**SX7 ENCIMERA 100 1Ø (40")**

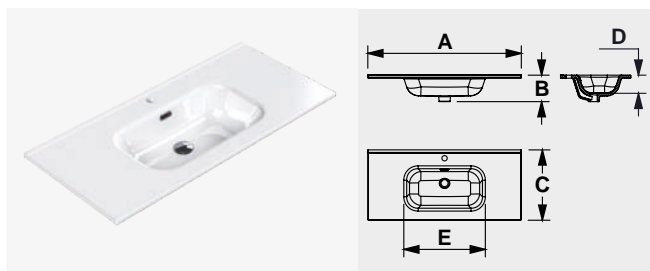

CERAMIC / CERÁMICA

Ref. 161430

A: 1015 mm. B: 175 mm. C: 465 mm.  
D: 120 mm. E: 505 mm.



STEP 3 - SELECT THE WALL VITRINE  
STEP 3 - SELECCIONA LA COLUMNA

WALL VITRINE 160 (64")  
COLUMNA 160 (64")

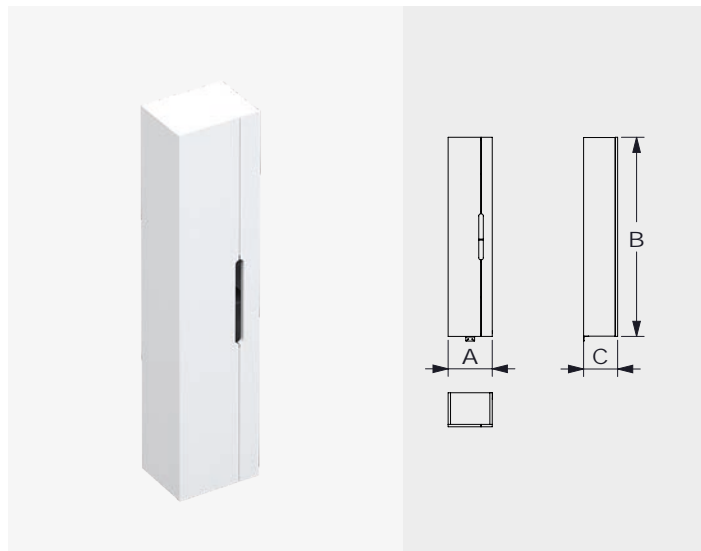

BLANCO SOFT  
STORM GREY SOFT  
OAK WOOD  
TOBACCO WOOD

Ref. 187010 A:350 mm. B: 1580 mm. C: 270 mm.  
Ref. 187027  
Ref. 187034  
Ref. 187751

FINISH OPTIONS  
OPCIONES DE ACABADOS



BLANCO SOFT  
Ref. 9992224O



STORM GREY SOFT  
Ref. 9992226G

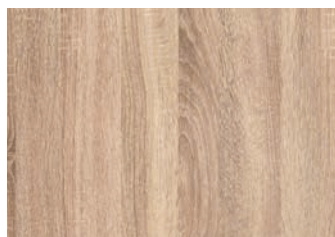

OAK WOOD  
Ref. 9992225G

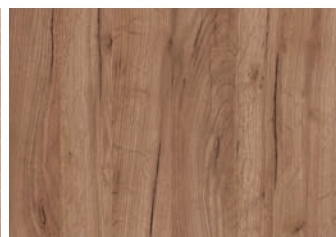

TOBACCO WOOD  
Ref. 9992226A

COMPLETE YOUR INSTALLATION  
COMPLETA TU INSTALACIÓN

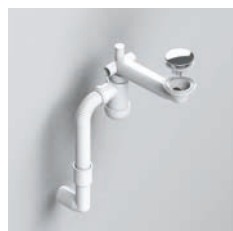

**PRELOC + CLICKER**  
TRAP 1 1/4"  
SIFÓN 1 1/4"

CLICKER CHROME Ref. 161508  
CLICKER WHITE Ref. 190102

PLAY



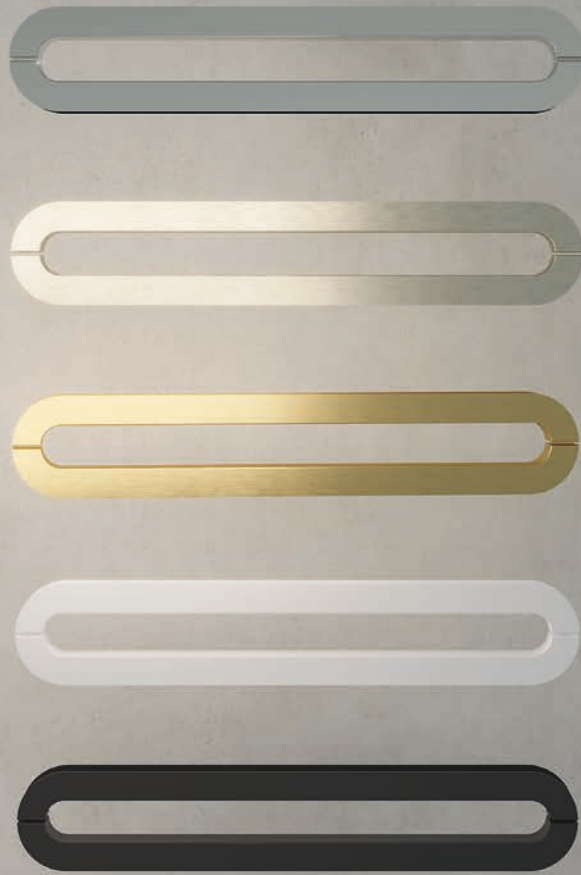

STEP 4 - SELECT THE SET OF HANDLES  
 STEP 4 - SELECCIONA LOS TIRADORES

PLAY SET HANDLE  
 PLAY SET DE TIRADORES

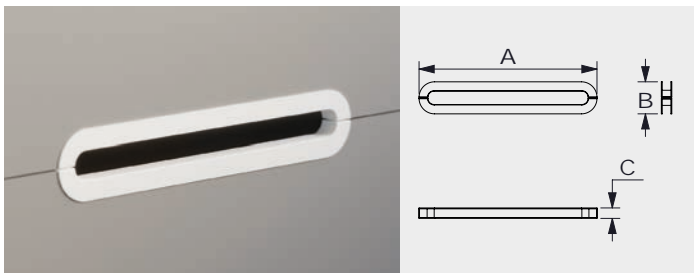

CHROME / CROMO  
 BRUSHED NICKEL  
 BRUSHED GOLD  
 WHITE  
 BLACK

Ref. 181155  
 Ref. 181131  
 Ref. 181124  
 Ref. 182039  
 Ref. 181148

A: 400 mm. B: 72 mm. C: 24 mm.



CHROME / CROMO



BRUSHED NICKEL



BRUSHED GOLD



WHITE



BLACK



CODE







**HUMIDITY RESISTANCE**  
RESISTENTE A LA HUMEDAD



**INSTALLATION TO THE WALL**  
INSTALACIÓN A PARED



**MAX LOAD CAPACITY**  
CAPACIDAD MÁXIMA



**DOUBLE LAYER PAINT**  
DOBLE CAPA PINTURA



**3/4" (19mm) HDF THICKNESS**  
3/4" 19MM ESPESOR



**SOFT CLOSE HARDWARE**  
CIERRE SUAVE



**CRAFTSMANSHIP**  
HECHO A MANO



**DRAWER ORGANIZER**  
CAJÓN ORGANIZADOR

### SPECS ESPECIFICACIONES TÉCNICAS

### BENEFITS BENEFICIOS

	SPECS ESPECIFICACIONES TÉCNICAS	BENEFITS BENEFICIOS
STRUCTURE ESTRUCTURA	<p>Thicknesses throughout the furniture of 19 mm. Particle board. HDF PVC edges 0.8 mm PUR technology (Reactive Polyurethane) Espesores de todo el mueble de 19 mm. Tablero partículas. HDF Cantos PVC 0.8 mm, tecnología PUR (Polyuretano reactivo).</p>	<p>Structure robustness. Humidity resistance. Estructura robusta. Resistente a la humedad.</p>
DRAWERS CAJONES  + DOORS PUERTAS	<p>12 mm ultraslim anthracite metal drawer. Drawer depth 19 mm. Full extraction. Load capacity 30 Kg Organizers included. Regulation and adjustments front. Doors 80 and 100 cm. Cajón metálico antracita ultra slim 12mm. Fondo cajón 19 mm. Extracción total. Capacidad carga 30 Kg. Organizadores incluidos. Regulación y ajuste frentes. Puertas de 80 y 100 cm.</p>	<p>Design, order and cleanliness. Soft close. Capacity. Diseño, orden y limpieza. Suavidad apertura / cierre silencioso. Capacidad.</p>
INSTALLATION INSTALACIÓN	<p>Hangers + wall plate made Italy. Compliance with all regulations and standarts. Drain valves in faucet finishes: chrome, gold, white, black. Patented flexible siphon. Colgadores + placa de pared hecha en Italia. Cumplimiento de todas las normativas y estandares. Válvulas desagüe en acabados grifería: cromo, oro, blanco, negro. Sifón flexible patentado.</p>	<p>Reliability, safety installation. Design and combination with other elements. Maximize drawer space. Reduces costs and facilitates plumbing installation. Fiabilidad, seguridad instalación. Diseño y combinación con el resto de elementos. Maximiza el espacio del cajón. Reduce costes y facilita la instalación de fontanería.</p>
LACQUERED FINISHES ACABADOS LACADOS	<p>Double layed paint on laminated fiber. Soft matte finishes. Glossy white finish. Doble capa de pintura sobre fibra laminada. Acabados mate soft. Acabado blanco brillo.</p>	<p>No aging. It looks like the first day. Hardness and resistance lacquered surface. No envejece. Mantiene aspecto como el primer día. Dureza y resistencia de superficies lacadas.</p>
WOOD FINISHES ACABADOS MADERA	<p>Latest technology laminates with synchronized grain. Laminados última tecnología con veta sincronizada.</p>	<p>Ultra natural realism. They improve the resistance and properties of the natural veneer. Ultrarealismo natural. Mejoran la resistencia y las propiedades de la chapa natural.</p>

# CODE

DISCREET AND SIMPLE EVERYWHERE



## BASE UNIT MUEBLE

60cm  
80cm  
100cm  
120cm



NORDIC WOOD



OAK WOOD

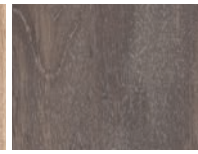

STORM WOOD

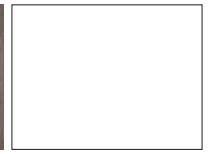

BLANCO GLOSS

## FINISHES ACABADOS



## BASIN LAVABO

MX1  
SX7



MINERAL MARMO



CERAMIC

## FINISHES ACABADOS



## WALL VITRINE COLUMNNA

120cm



NORDIC WOOD



OAK WOOD



STORM WOOD



BLANCO GLOSS

## FINISHES ACABADOS

CODE



CODE

---



CODE

---



CODE

---



CODE

---





CODE

---





CODE

---



# CODE

CREATE YOUR CODE  
CREA TU CODE

STEP 1  
SELECT THE BASE UNIT  
SELECCIONA EL ARMAZÓN

STEP 2  
SELECT THE BASIN  
SELECCIONA EL LAVABO

STEP 3  
SELECT THE COMPLEMENTS  
SELECCIONA LOS COMPLEMENTOS

## STEP 1 - SELECT THE BASE UNIT STEP 1 - SELECCIONA EL ARMAZÓN

### BASE UNIT 60 (24") ARMAZÓN 60 (24")

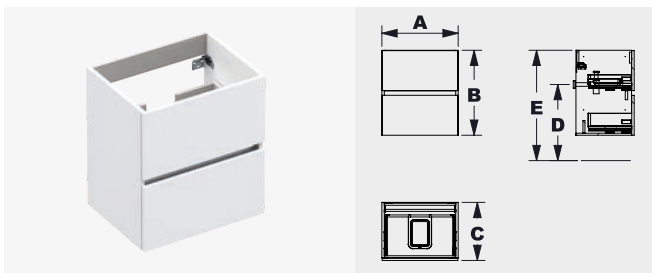

BLANCO GLOSS  
NORDIC WOOD  
OAK WOOD  
STORM WOOD

Ref. 187041  
Ref. 187065  
Ref. 187072  
Ref. 187096

A: 600 mm. B: 670 mm. C: 458 mm.  
D: 570-620 mm. E: 870 mm.

### BASE UNIT 80 (32") ARMAZÓN 80 (32")

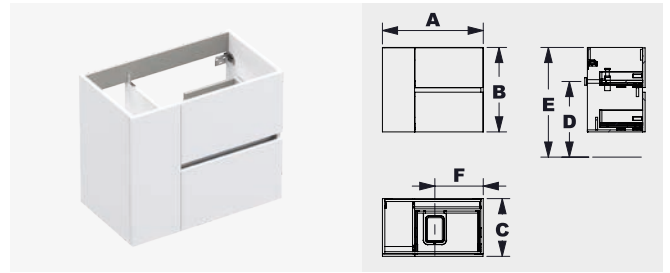

BLANCO GLOSS  
NORDIC WOOD  
OAK WOOD  
STORM WOOD

Ref. 187102  
Ref. 187126  
Ref. 187133  
Ref. 187157

A: 800 mm. B: 670 mm. C: 458 mm.  
D: 570-620 mm. E: 870 mm. F: 386 mm.

### BASE UNIT 100 (40") ARMAZÓN 100 (40")

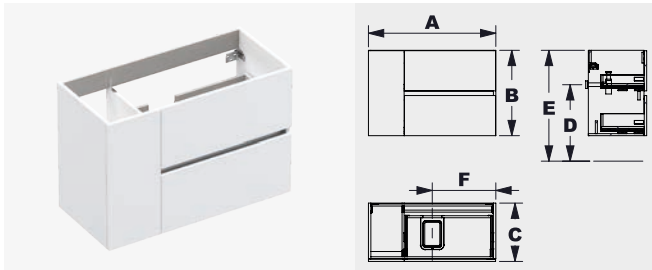

BLANCO GLOSS  
NORDIC WOOD  
OAK WOOD  
STORM WOOD

Ref. 187164  
Ref. 187188  
Ref. 187195  
Ref. 187218

A: 1000 mm. B: 670 mm. C: 458 mm.  
D: 570-620 mm. E: 870 mm. F: 499 mm.

### BASE UNIT 120 (47") ARMAZÓN 120 (47")

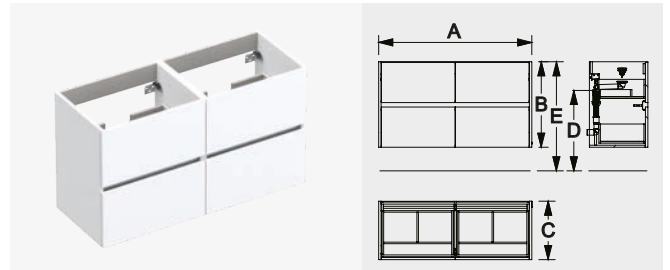

BLANCO GLOSS  
NORDIC WOOD  
OAK WOOD  
STORM WOOD

Ref. 188581  
Ref. 188598  
Ref. 188604  
Ref. 188611

A: 1200 mm. B: 670 mm. C: 458 mm.  
D: 570-620 mm. E: 870 mm. F: 601 mm.

## FINISH OPTIONS OPCIONES DE ACABADOS



BLANCO GLOSS  
Ref. 9992225O



NORDIC WOOD  
Ref. 9992225Y

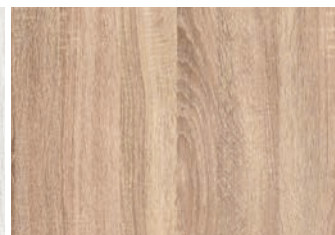

OAK WOOD  
Ref. 9992225V

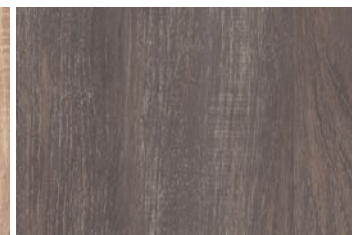

STORM WOOD  
Ref. 9992226B

STEP 2 - SELECT THE BASIN  
STEP 2 - SELECCIONA EL LAVABO

**SX7 BASIN 60 1Ø (24")**  
**SX7 ENCIMERA 60 1Ø (24")**

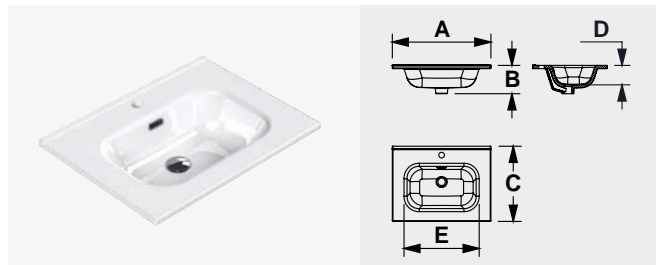

CERAMIC / CERÁMICA

Ref. 161416

A: 615 mm. B: 175 mm. C: 465 mm.  
D: 120 mm. E: 465 mm.

**MX1 BASIN 60 1Ø (24")**  
**MX1 ENCIMERA 60 1Ø (24")**

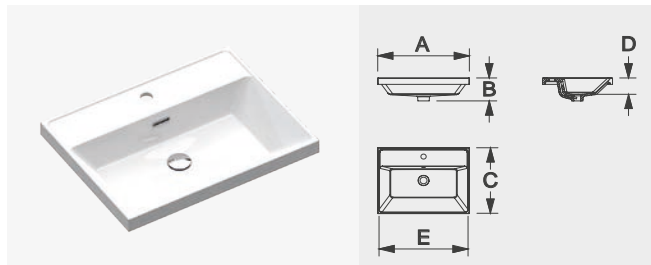

MINERAL MARMO®

Ref. 161195

A: 606 mm. B: 161 mm. C: 463 mm.  
D: 115 mm. E: 585 mm.

Available with ØØ Disponible en ØØ.

**SX7 BASIN 80 1Ø (32")**  
**SX7 ENCIMERA 80 1Ø (32")**

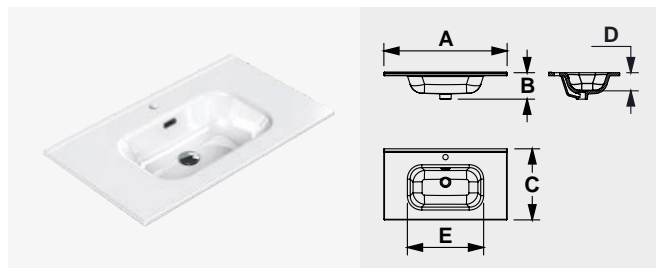

CERAMIC / CERÁMICA

Ref. 161423

A: 815 mm. B: 175 mm. C: 465 mm.  
D: 120 mm. E: 500 mm.

**MX1 BASIN 80 1Ø (32")**  
**MX1 ENCIMERA 80 1Ø (32")**

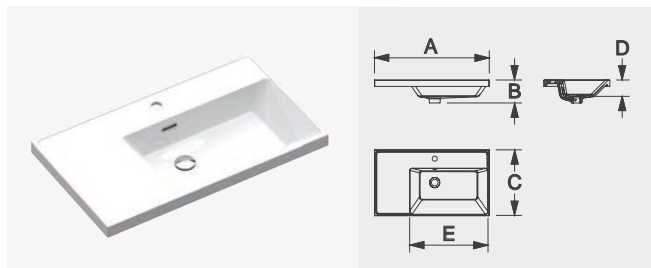

MINERAL MARMO®

Ref. 161171

A: 806 mm. B: 161 mm. C: 463 mm.  
D: 115 mm. E: 546 mm.

Available with ØØ Disponible en ØØ.

**SX7 BASIN 100 1Ø (40")**  
**SX7 ENCIMERA 100 1Ø (40")**

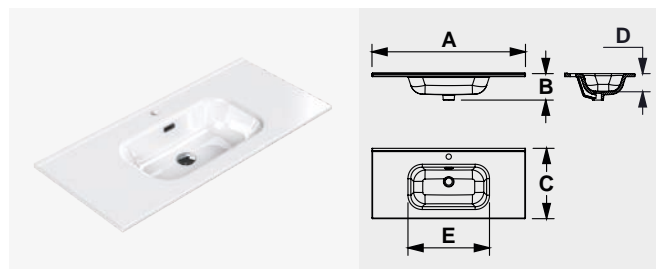

CERAMIC / CERÁMICA

Ref. 161430

A: 1015 mm. B: 175 mm. C: 465 mm.  
D: 120 mm. E: 535 mm.

**MX1 BASIN 100 1Ø (40")**  
**MX1 ENCIMERA 100 1Ø (40")**

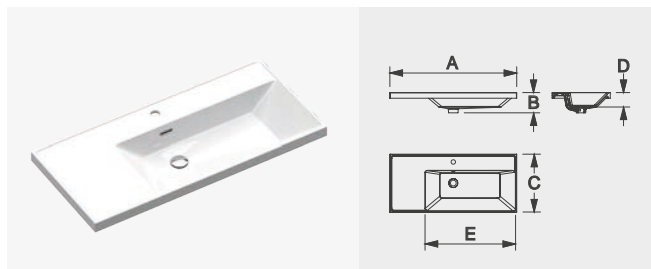

MINERAL MARMO®

Ref. 161188

A: 1006 mm. B: 161 mm. C: 463 mm.  
D: 115 mm. E: 718 mm.

Available with ØØ Disponible en ØØ.

**SX7 BASIN 120 1Ø DOUBLE (48")**  
**SX7 ENCIMERA DOBLE 120 1Ø (48")**

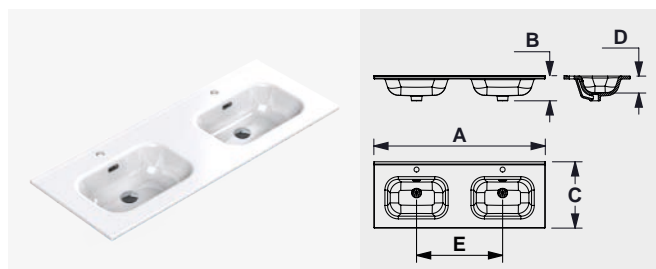

CERAMIC / CERÁMICA

Ref. 161447

A: 1215 mm. B: 175 mm. C: 465 mm.  
D: 120 mm. E: 610 mm.

**MX1 BASIN 120 1Ø DOUBLE (48")**  
**MX1 ENCIMERA DOBLE 120 1Ø (48")**

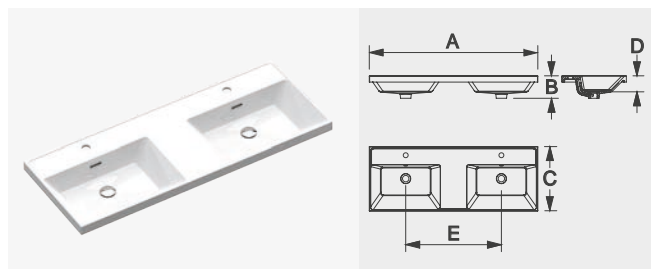

MINERAL MARMO®

Ref. 161201

A: 1206 mm. B: 161 mm. C: 463 mm.  
D: 115 mm. E: 687 mm.

Available with ØØ Disponible en ØØ.

CODE



STEP 3 - SELECT THE COMPLEMENTS  
STEP 3 - SELECCIONA LOS COMPLEMENTOS

WALL VITRINE 120 (48")  
COLUMNA 120 (48")

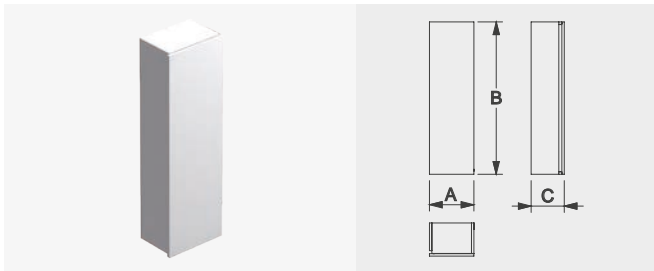

BLANCO GLOSS  
NORDICWOOD  
OAKWOOD  
STORMWOOD

Ref. 161379  
Ref. 187225  
Ref. 172702  
Ref. 187256

A: 350 mm. B: 1200 mm. C: 261 mm.

TRAP COVER TRAY  
BANDEJA CUBRE SIFÓN

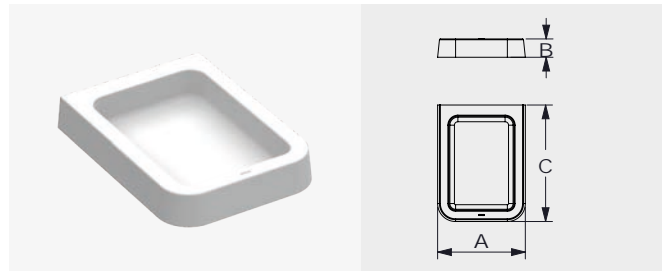

WHITE / BLANCO

Ref. 190119

COMPLETE YOUR INSTALLATION  
COMPLETA TU INSTALACIÓN

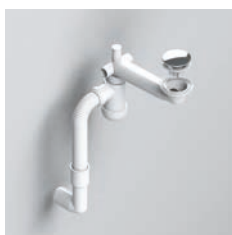

PRELOC + CLICKER  
TRAP 1 1/4"  
SIFÓN 1 1/4"

CLICKER CHROME Ref. 161508  
CLICKER WHITE Ref. 190102

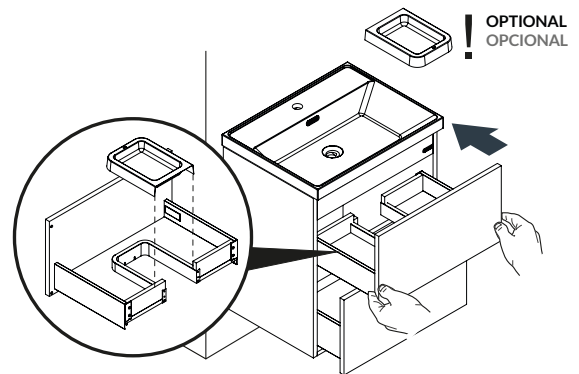

CODE



PUZZLE









**HUMIDITY RESISTANCE**  
RESISTENTE A LA HUMEDAD



**INSTALLATION TO THE WALL**  
INSTALACIÓN A PARED



**MAX LOAD CAPACITY**  
CAPACIDAD MÁXIMA



**DOUBLE LAYER PAINT**  
DOBLE CAPA PINTURA



**3/4" (19mm) HDF THICKNESS**  
3/4" 19MM ESPESOR



**SOFT CLOSE HARDWARE**  
CIERRE SUAVE



**CRAFTSMANSHIP**  
HECHO A MANO



**DRAWER ORGANIZER**  
CAJÓN ORGANIZADOR

	SPECS ESPECIFICACIONES TÉCNICAS	BENEFITS BENEFICIOS
STRUCTURE ESTRUCTURA	<p>Thicknesses throughout the furniture of 19 mm. Particle board. HDF PVC edges 0.8 mm PUR technology (Reactive Polyurethane) Espesores de todo el mueble de 19 mm. Tablero partículas. HDF Cantos PVC 0.8 mm, tecnología PUR (Polyuretano reactivo).</p>	<p>Structure robustness. Humidity resistance. Estructura robusta. Resistente a la humedad.</p>
DOORS PUERTAS	<p>Hinges with brake. Bisagras con freno.</p>	<p>Soft close. Opening design for each design. Suavidad apertura / cierre silencioso. Soluciones de apertura para cada diseño.</p>
INSTALLATION INSTALACIÓN	<p>Hangers + wall plate made Italy. Compliance with all regulations and standards. Drain valves in faucet finishes: chrome, gold, white, black. Patented flexible siphon. Colgadores + placa de pared hecha en Italia. Cumplimiento de todas las normativas y estándares. Válvulas desagüe en acabados grifería: cromo, oro, blanco, negro. Sifón flexible patentado.</p>	<p>Reliability, safety installation. Design and combination with other elements. Maximize drawer space. Reduces costs and facilitates plumbing installation. Fiabilidad, seguridad instalación. Diseño y combinación con el resto de elementos. Maximiza el espacio del cajón. Reduce costes y facilita la instalación de fontanería.</p>
LACQUERED FINISHES ACABADOS LACADOS	<p>Double layered paint on laminated fiber. Soft matte finishes. Doble capa de pintura sobre fibra laminada. Acabados mate soft.</p>	<p>No aging. It looks like the first day. Hardness and resistance lacquered surface. No envejece. Mantiene aspecto como el primer día. Dureza y resistencia de superficies lacadas.</p>
WOOD FINISHES ACABADOS MADERA	<p>Latest technology laminates with synchronized grain. Laminados última tecnología con veta sincronizada.</p>	<p>Ultra natural realism. They improve the resistance and properties of the natural veneer. Ultrarealismo natural. Mejoran la resistencia y las propiedades de la chapa natural.</p>

# PUZZLE

MORE SPACE



**BASE UNIT**  
MÓDULOS

50cm

**FINISHES**  
ACABADOS

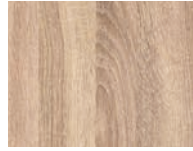

OAK WOOD

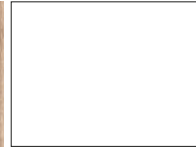

BLANCO SOFT



STORM GREY SOFT



**BASIN**  
LAVABO

MX4

**FINISHES**  
ACABADOS



MINERAL SOLID

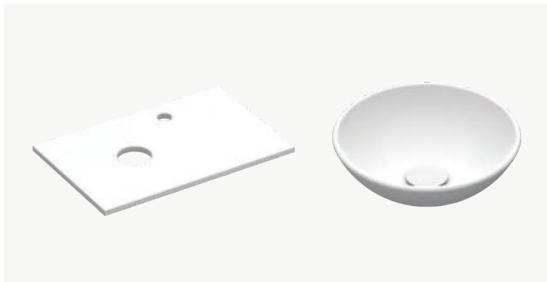

**COUNTER + BASIN**  
ENCIMERA + LAVABO

50cm

**FINISHES**  
ACABADOS



WHITE STONE



TORTORA STONE

PUZZLE

---



# PUZZLE

---



# PUZZLE

---



PUZZLE

---



# PUZZLE

## BASE UNIT 50 (20") ARMAZÓN 50 (20")

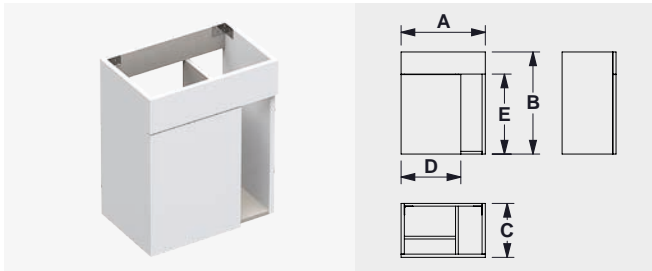

BLANCO SOFT  
STORM GREY SOFT  
OAKWOOD

Ref. 190133 A: 495 mm. B: 600 mm. C: 317 mm.  
Ref. 190140 D: 351 mm. E: 470 mm.  
Ref. 173075

Left door open push system.  
Puerta apertura izquierda push.

## MX4 BASIN 50 1Ø (20") MX4 ENCIMERA 50 1Ø (20")

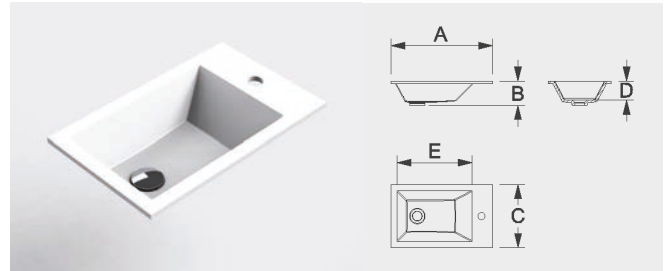

MINERAL SOLID®

Ref. 163809

A: 500 mm. B: 118 mm. C: 320 mm.  
D: 92 mm. E: 370 mm.

Available with ØØ  
Disponible en ØØ

## MICROTECH COUNTER 500 MM. 1Ø (20") MICROTECH ENCIMERA 500 MM. 1Ø (20")

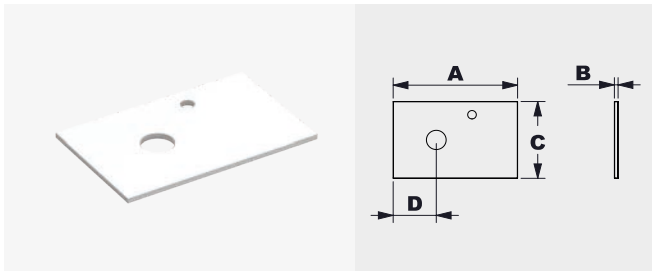

WHITE STONE  
TORTORA STONE

Ref. 190157  
Ref. 190164

A: 505 mm. B: 15 mm.  
C: 320 mm. D: 175 mm.

## SX12 BASIN CERAMIC Ø28 (11") SX12 LAVABO CERÁMICA Ø28 (11")

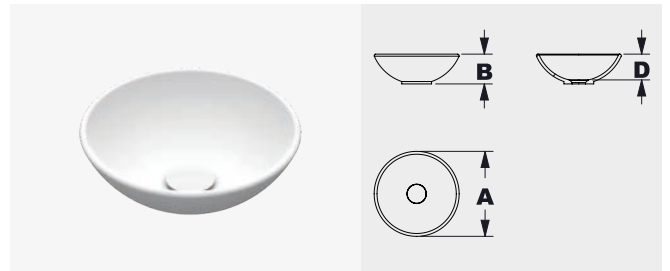

WHITE MATT  
TORTORA MATT

Ref. 190171  
Ref. 190188

A: 285 mm. B: 100 mm. D: 87 mm.

## ADHESIVE TOWEL BAR 300 (12") TOALLERO BARRA ADHESIVO 300 (12")

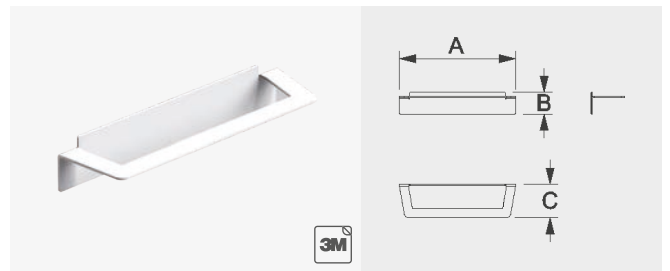

WHITE / BLANCO

Ref. 157365

A: 285 mm. B: 53 mm. C: 82 mm.

Adhesive fastening system.  
Fijación adhesiva.

## COMPLETE YOUR INSTALLATION COMPLETA TU INSTALACIÓN



TRAP  
WASTEP-TRAP 1¼"  
SIFÓN DESAGÜE 1¼"

CHROME / CROMO  
Ref. 097388



CLICKER  
PUSH DOWN  
Ø 65 Mm. 1 ¼"  
VÁLVULA CLICKER  
Ø 65 Mm. 1 ¼"

CHROME Ref. 123940  
WHITE Ref. 188895  
TORTORA Ref. 188901





## COUNTER + BASIN FINISH OPTIONS OPCIONES DE ACABADOS ENCIMERA + LAVABO



WHITE STONE



TORTORA STONE

## BASE UNIT FINISH OPTIONS OPCIONES DE ACABADOS MUEBLE



BLANCO SOFT  
Ref. 99922240



STORM GREY SOFT  
Ref. 9992225E

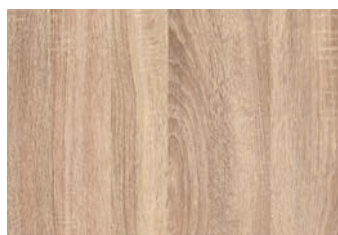

OAKWOOD  
Ref. 9992225G

ÉPOQUE



# MIRRORS & LIGHTS ESPEJOS & ILUMINACIÓN

MIRRORS ESPEJOS	CM CM
BASIC	80   90   100   120
BASIC Ø	60   80
LLUNA Ø	80
NOVA Ø	80
ÉPOQUE	81
ALUGLASS	80   90   100   120
VORA	80   90   100
ALULIGHT	80   100   120
ALUMINIUM LIGTH	80   100   120
BACK LIGHT	80   100
CABINETS	60   80   100   120

LIGHTS LUCES	MM MM	FINISH ACABADO
F09 LED	515	ALUMINIUM
F1 LED	300   450   600	CHROME
F12	300	CHROME   BLACK
F13	450	CHROME
F14	600	CHROME
F18	300	CHROME

## Color temperature / Temperatura de color

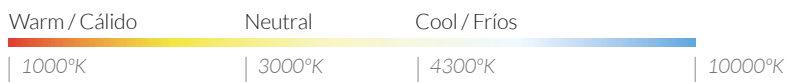

## Icon legend / Leyenda iconos

- Protection IP 20
- Zone 3
- Power
- LED
- Protection IP 44
- Zone 2
- Demister
- Class 2

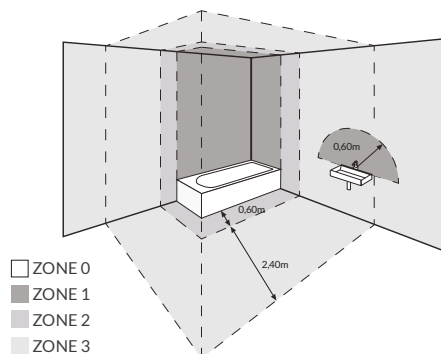

BASIC



# MIRRORS / ESPEJOS



## BASIC

A (cm)	B (cm)	C (cm)	Ref.
80	50	2	189816
80	60	2	154296
90	70	2	154302
100	40	2	119370
100	80	2	154319
120	80	2	189823

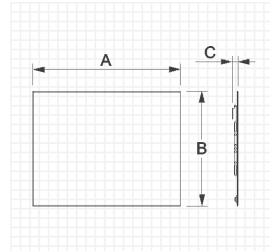

- 4mm beveled glass mirror.
- Horizontal and vertical fixation system.
- Luna biselada de 4 mm.
- Sistema de instalación vertical y horizontal.



## BASIC

AØ(cm)	C (cm)	Ref.
60	3	184835
80	3	184842

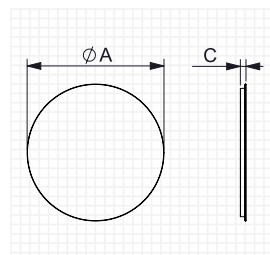

- 4mm polished edge glass.
- Luna canto pulido 4 mm.

NOVA



# LLUNA

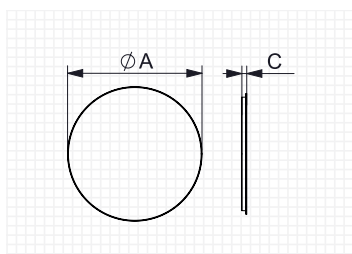

## NOVA

AØ (cm)	C (cm)	Watt	LM	Ref.
80	3	21,7	2170	184743

**A++** **ZONE 2** **IP44** **TT** **5500°K**

- Back LED light.
- 4mm beveled glass mirror.
- Luz LED retroiluminado.
- Luna biselada de 4 mm.

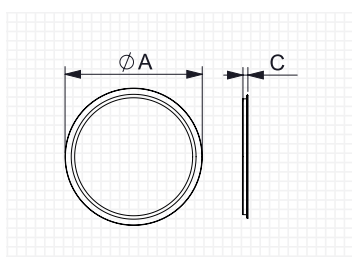

## LLUNA

AØ (cm)	C (cm)	Watt	LM	Ref.
80	3	20,6	2060	184767

**A++** **ZONE 2** **IP44** **TT** **5500°K**

- Front LED light.
- 4mm beveled glass mirror.
- Luz LED frontal.
- Luna biselada de 4 mm.

# MIRRORS / ESPEJOS



## ÉPOQUE

A (cm)	B (cm)	C (cm)	Watt	LM	Ref.
81	81	3	2400	2400	184729

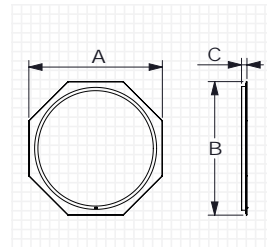

- Front LED light.
- 4mm beveled glass mirror.
- Luz LED frontal.
- Luna biselada de 4 mm.



## ALUGLASS

A (cm)	B (cm)	C (cm)	Ref.	Finish
80	60	2,5	162000	ALU
80	60	2,5	183654	BLACK
100	70	2,5	162017	ALU
100	70	2,5	189892	BLACK
120	80	2,5	162024	ALU
120	80	2,5	189908	BLACK

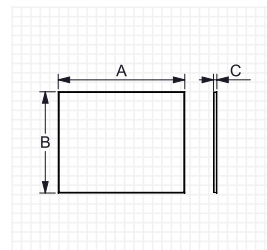

- Glass mirror with pvc aluminum frame.
- Horizontal and vertical fixation system.
- Luna con marco pvc de aluminio.
- Sistema de colocación horizontal y vertical.



## VORA

A (cm)	B (cm)	C (cm)	Watt	LM	Ref.
90	45	2,5	24	2400	186488
80	60	2,5	24,6	2460	186471
100	80	2,5	32	3200	186495

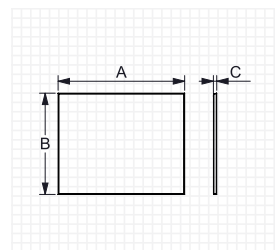

- Back LED light.
- 4mm beveled glass mirror.
- Horizontal and vertical fixation system.
- Luz LED retroiluminado.
- Luna biselada de 4 mm.
- Sistema de colocación horizontal y vertical.





# MIRRORS / ESPEJOS



## ALULIGHT

A (cm)	B (cm)	C (cm)	Watt	LM	Ref.
80	60	2,5	4,3	430	164103
100	80	2,5	8,1	810	164110
120	80	2,5	10	1000	164127

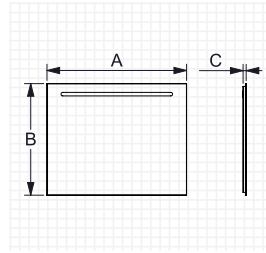

- Front LED light.
- 4mm beveled glass mirror.
- Horizontal and vertical fixation system.
- Luz LED frontal.
- Luna biselada de 4 mm.
- Sistema de colocación horizontal y vertical.

**A++** ZONE 2 IP44 TT 5500°K



## ALUMINIUM LIGHT

A (cm)	B (cm)	C (mm)	Watt	LM	Ref.	Finish
80	60	28	25	2112	161126	ALU
80	60	28	25	2112	189946	BLACK
100	80	28	33	1756	161133	ALU
100	80	28	33	1756	189953	BLACK
120	80	28	37	3072	168248	ALU
120	80	28	37	3072	189960	BLACK

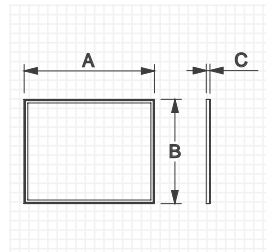

- Front LED light.
- Glass mirror with pvc aluminum frame.
- Horizontal and vertical fixation system.
- Luz LED frontal.
- Luna con marco pvc de aluminio.
- Sistema de colocación horizontal y vertical.

**A++** ZONE 2 IP44 TT 5500°K



## BACK LIGHT

A (cm)	B (cm)	C (cm)	Watt	LM	Ref.
80	60	2,5	25	2112	161140
100	80	2,5	33	1756	161157

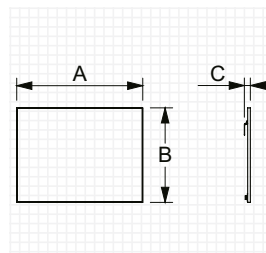

- Back LED light.
- 4mm beveled glass mirror.
- Horizontal and vertical fixation system.
- Luz LED retroiluminado.
- Luna biselada de 4 mm.
- Sistema de colocación horizontal y vertical.

**A++** ZONE 2 IP44 TT 5500°K

# CABINETS





#### CABINET LED

DOORS	A (cm)	B (cm)	C (cm)	LM	Watt	Ref.
2	60	65	15	882	12W	167258
2	80	65	15	882	12W	167265
3	100	65	15	882	12W	167272
3	120	65	15	882	12W	167289

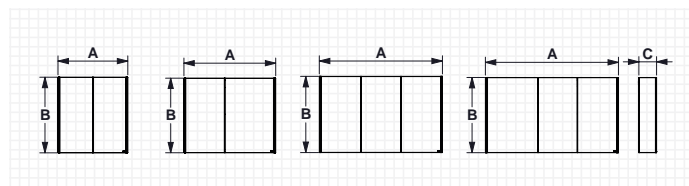

- Double glass mirror doors. (Interior / Exterior)
- Soft-close system.
- Adjustable glass shelf.
- Interior sock.
- Puertas de doble luna espejo. (Interior/Exterior).
- Cierre amortiguado.
- Estante de cristal regulable.
- Enchufe interior.

**5500°K**

# LIGHTS

## F09 LED



- Installation screwed or stuck on the mirror.
- Colocación: pegado o atornillado a espejo.
- Installation screwed for cabinet mirror.
- Colocación sobre espejo cabinet.

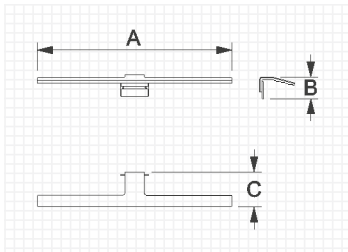

5000°K

MODEL	A (mm)	B (mm)	C (mm)	LM	Watt	Ref.
CABINET	515	57	130	554	9,5	154531
MIRROR	515	57	93	554	9,5	154494

## F1 LED



- Installation screwed or clipped on mirror, clip hardware included.
- Colocación atornillado al espejo o con pinza sobre luna.

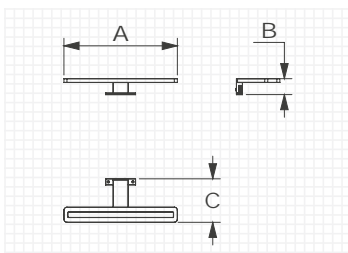

6000°K

A (mm)	B (mm)	C (mm)	LM	Watt	Ref.
300	42	115	550	7	177585
450	42	115	600	7	177592
600	42	115	1275	17	177608

## F12 - F13 - F14 - F18 LED



F12



F13



F14



F18

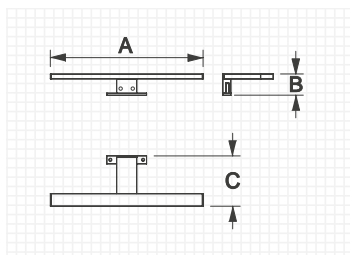

**A++** **ZONE 2** **IP44** **TT** **6000°K**

- Installation screwed or clipped on mirror, clip hardware included.
- Colocación atornillado a espejo o con pinzas sobre luna. Pinza incl.

MODEL	A (mm)	B (mm)	C (mm)	LM	W	Finish	Ref.
F12	300	42	115	550	7	CHROME	162048
F12	300	42	115	550	7	BLACK	189984
F13	450	42	115	600	7	CHROME	162055
F14	600	42	103	1275	14	CHROME	191277
F18	300	42	115	400	5,4	CHROME	164288



## GUARANTEE

Sonia guarantee is 10 years for accessory and 3 years for furniture, wash basins, mirrors, lighting and contract equipment. Always from the purchase date.

And only covering materials and manufacturing process defects.

The guarantee will not cover problems consequence of misuse, wrong maintenance, product modifications and the wear caused by normal use of the products.

In order to submit a claim the product, the original invoice and this document should be hand into the place you bought it.

Recomendations:

- Always clean with a cloth dampened with water and then dried.
- Do not use products or scouring pads that may damage the surface.
- Always follow the cleaning, maintenance and installation instructions you will find with each product.
- Use the product according to its functionality.

## GARANTÍA

Sonia garantiza, a partir de la fecha de compra, por un periodo de 10 años de garantía en todos sus accesorios. Para la gama de muebles, lavabos, espejos, iluminación y artículos contract, el periodo de garantía será de 3 años.

Esta garantía cubre los problemas que tengan origen en defectos de fabricación o materiales.

La garantía no cubre los desperfectos ocasionados por el mal uso, mantenimiento indebido, modificaciones o reparaciones realizadas por terceros y el desgaste originado por el uso normal de los productos.

En caso de incidencia, deberá entregarse el producto en el establecimiento de compra acompañado de esta garantía y la factura de compra original.

Recomendaciones:

- Limpiar siempre con un paño humedecido con agua y posteriormente secar.
- No usar productos ni esponjas abrasivas que puedan dañar la superficie.
- Seguir siempre las indicaciones de limpieza, mantenimiento y montaje que incluya el producto.
- Hacer uso del producto según la naturaleza para la que ha sido diseñado.



# QUALITY CALIDAD

With the commitment to continually improve its products, processes, services and systems, Sonia has implemented ISO 9001. This commitment is reflected in our Quality Policy, which provides a reference framework for establishing management objectives as well as guiding all its processes towards the satisfaction of business stakeholders:

Satisfaction of expectations of business stakeholders.

Continuous improvement of the Management System, Products, Services and Processes.

Compliance with legal, technical and market requirements.

Accomplishment of the goals

Integration of the value chain.

## **Furniture:**

UNE EN 14749, Domestic and kitchen storage units and worktops - Safety requirements and test methods.

UNE 56867, Bathroom furniture. Testing of surface finishes.

UNE 56868, Bathroom furniture. Physical test methods.

## **Basins:**

UNE 67001, Ceramic sanitary ware. Technical specifications.

UNE EN 31, Wash basins - Connecting dimensions.

UNE EN 14688, Sanitary appliances - Wash basins - Functional requirements and test methods.

## **Accessories:**

UNE 67100, Bathroom accessories. Definitions, general characteristics and tests:

Corrosion tests:

UNE-EN-ISO 9227. Corrosion tests in artificial atmospheres - Salt spray tests.

EN-ISO 10289. Methods for corrosion testing of metallic and other inorganic coatings on metallic substrates - Rating of test specimens and manufactured articles subjected to corrosion tests.

Sonia standard test: 216 hours vs 96 hours as per the norm.

UNE-EN ISO 27874. Metallic and other inorganic coatings - Electrodeposited gold and gold alloy coatings for electrical, electronic and engineering purposes - Specification and test methods .

ISO 4524-2. Metallic coatings. Test methods for electrodeposited gold and gold alloys coatings. Part 2: Environmental tests.

Adhesion tests:

UNE-EN 248. Sanitary tapware - General specification for electrodeposited coatings of Ni-Cr.

UNE-EN ISO 27874. Metallic and other inorganic coatings - Electrodeposited gold and gold alloy coatings for electrical, electronic and engineering purposes - Specification and test methods.

UNE-EN ISO 2409. Paints and varnishes. Cross-cut test.

Sonia con el compromiso de mejorar continuamente sus productos, procesos, servicios y sistemas ha implementado la ISO 9001. Este compromiso se plasma en nuestra Política de Calidad que proporciona un marco de referencia para el establecimiento de los objetivos de gestión así como orientar todos sus procesos hacia la satisfacción de las partes interesadas del negocio:

Satisfacción de expectativas de las partes interesadas del negocio.

Mejora continua del Sistema de Gestión, Productos, Servicios y Procesos.

Cumplimiento de los requisitos legales, técnicos y de mercado.

Cumplimiento de los objetivos

Integración de la cadena de valor.

## **Mueble:**

UNE EN 14749, Muebles contenedores y planos de trabajo para uso doméstico y en cocinas. Requisitos de seguridad y métodos de ensayo.

UNE 56867, Muebles de Baño ensayos de revestimientos superficiales.

UNE 56868, Muebles de Baño ensayos físicos.

## **Lavabos**

UNE 67001, Aparatos sanitarios cerámicos. Especificaciones técnicas.

UNE EN 31, Lavabos. Cotas de conexión.

UNE EN 14688, Aparatos sanitarios. Lavabos. Requisitos funcionales y métodos de ensayo.

## **Accesorios**

UNE 67100, Accesorios de baño. Definiciones, características generales y ensayos:

Ensayos de corrosión

UNE-EN-ISO 9227. Ensayos de corrosión en atmósferas artificiales. Ensayos de niebla salina.

EN-ISO 10289. Métodos de ensayo de corrosión de recubrimientos metálicos y no orgánicos sobre sustratos metálicos. Clasificación de probetas y piezas de protección sometidas a ensayos de corrosión.

Hacemos 216 horas de ensayo frente a las 96 que marca la norma.

UNE-EN ISO 27874. Recubrimientos metálicos y otros recubrimientos inorgánicos. Recubrimientos electrolíticos de oro y aleaciones de oro para usos eléctricos, electrónicos e industriales. Especificaciones y métodos de ensayo.

ISO 4524-2. Recubrimientos metálicos. Métodos de ensayo de los depósitos electrolíticos de oro y aleaciones de oro. Parte 2: ensayos climáticos.

## **Ensayos de Adherencia**

UNE-EN 248. Grifería sanitaria. Especificaciones técnicas generales de los revestimientos electrolíticos de Ni-Cr.

UNE-EN ISO 27874. Recubrimientos metálicos y otros recubrimientos inorgánicos. Recubrimientos electrolíticos de oro y aleaciones de oro para usos eléctricos, electrónicos e industriales. Especificaciones y métodos de ensayo.

UNE-EN ISO 2409. Pinturas y barnices. Ensayo de corte por enrejado.

# MAINTENANCE

## Care & Maintenance Bathroom Accessories

Sonia Accessories are known and admired for the long lasting quality and intense gloss in their finish.

In order to maintain your Sonia accessories with its brand new luster, it is important to follow some simple instructions:

- Use only neutral non-abrasive detergents.
- It is recommended to use a soft cloth, do not use abrasive cleaners, steel wool or pads.
- Do not spray cleaning agents directly on the accessories under any circumstance, spray on the cloth, since spray liquid can come into openings or holes of the products and cause damages.
- The use of steam cleaners is not recommended since the extreme high temperature of steam can compromise the integrity of the coating finish of the product.

## Furniture Maintenance

### GENERAL INFORMATION FOR ALL SURFACES:

The beauty and the life of our wood finish products will endure for years depending on the care they receive.

Sonia furniture is manufactured using materials ideal for use in an often-humid bathroom environment. Nevertheless, in bath design, it is always important to ensure the furniture is placed at a clear distance from your bath or shower to avoid continuous direct splashes of water and soap residue. When splashed with water, wipe furniture dry on order to minimize the risk of damage.

### Cleaning instructions:

- We recommend cleaning with a soft damp cloth and a mild all-purpose cleaning agent. (Spray the cleaning agent on to a damp cloth and wipe the surface. Never spray directly onto the furniture).
- We advise against vigorous rubbing as this may cause stains and damage.
- It is very important to keep the cabinet surfaces dry. Wipe up spills immediately using a dry cloth with a "blotting" motion, rather than wiping the spill from the cabinet surface. Pay special attention to areas where water is common, such as the sink and dishwasher, and do not allow water and detergents to dry on the cabinet surface.
- Wipe with a damp cloth wrung in clean water to remove the cleaning agent and to avoid stains and stripes.

- Avoid using dry cloths and paper tissue for furniture with matt and high-gloss surfaces, as these may scratch the surface.

- Do not use abrasive cleaning agents or cleaning agents that contain ammonia, bleach or other strong solvents as these will damage the furniture.

- Avoid excessive moisture. This is one of the worst enemies of any finish. Avoid draping wet towels over cabinet doors. Do not attach towel racks to door interiors. Immediately dry off any areas where water has spilled.

- Avoid excessive heat. Avoid placing cabinet appliances where the heat is directed onto cabinet surfaces. The stability of the wood and finish can be negatively impacted.

### Final thoughts

Wood products and their finish are only as good as the care they receive. Proper care as recommended will extend the life and beauty of your cabinet. Remember, leaving water or other moisture on the cabinet surface for extended periods of time will harm the finish.

# MANTENIMIENTO

## Mantenimiento accesorios baño

Los accesorios de Sonia son admirados por su calidad y brillo intenso que perdura a lo largo de la vida.

Para que tus accesorios conserven el brillo del primer día es importante seguir unas sencillas instrucciones de mantenimiento:

- Usar sólo detergentes neutros no abrasivos.
- Es recomendable utilizar un paño suave, no utilizar utensilios abrasivos, esponjas metálicas o estropajos.
- No conviene rociar agentes limpiadores en ningún caso sobre los accesorios, sino sobre el paño, cualquier líquido pulverizado puede entrar en aperturas o hendiduras de los productos y causar daños.
- La utilización de limpiadores a vapor no está permitida, las altas temperaturas pueden dañar los productos.

## Mantenimiento mobiliario

### INFORMACION GENERAL PARA TODAS LAS SUPERFICIES:

La belleza de los productos acabados en madera permanecerá intacta durante años si les damos los cuidados adecuados.

La selección de materiales para los cuartos de baño de Sonia la hacemos cuidadosamente con los materiales adecuados para el uso en ambientes húmedos. Es conveniente, sin embargo, asegurarnos de que en su instalación guardamos una distancia de seguridad prudencial con la ducha o bañera para evitar salpicaduras directas o residuos de jabón, y en caso de que se produzcan proceder a secar el mueble para minimizar posibles daños.

### Instrucciones de limpieza:

- Recomendamos limpiar su mueble con un paño suave y un limpiador multiusos no abrasivo. (Coloque el agente limpiador directamente en el paño y limpie entonces la superficie, por favor no dirija el pulverizador directamente hacia el mueble).
- Frótelo suavemente, el hacerlo

vigorosamente podría causar manchas o daños.

- Es muy importante mantener las superficies del mueble secas, le recomendamos poner atención en las zonas donde el agua es habitual, como zonas próximas al lavamanos, y secar con un paño los excesos de agua o jabones.

- En muebles con brillo le recomendamos no utilizar toallas de papel o paños secos que podrían rallar la superficie.

- No utilizar agentes abrasivos que contengan amoníaco, lejía o disolventes que puedan dañar la Madera.

- Los excesos de agua son los peores enemigos de la madera, evite limpiarlos por dentro o fuera con ninguna fuente directa de agua, y recordar siempre secar los excesos.

- Evite fuentes de calor directas, tipo limpiadores de vapor, hacia las superficies de su mueble.

Recuerde, el agua o cualquier líquido estancado en la superficie de su mueble dañaría el acabado y no estaría cubierto por ninguna garantía.



# TRANSPORT GUARRANTIES

At Sonia we have a real passion for quality that is why we apply strict guidelines for each and every process, starting from the entry of the materials into our warehouses, all the way through to the shipment of the correctly packed goods. That way we can guarantee that our clients can continue to enjoy the beauty and quality of our products.

To facilitate this there is a time period, during the transport of the goods, where we will need your close collaboration in order to ensure the maximum quality of the products.

We expect you to examine the materials once you have received them in order to make sure that it was delivered to you in perfect condition, because we provide up to 48 hours to make a claim in case of damages:

1. If you are absolutely sure that the material was delivered in perfect condition, please sign the delivery note without any further remarks.
2. In the case of any issues, or if you are not able to properly examine the goods then please add the following text in the delivery note: "Damaged packaging".
3. In case of damage to the materials themselves, the delivery note should be marked with the text "Damaged goods".

By performing these easy steps, the transport agencies and the insurance companies will be able to respond quickly and effectively for any damage caused during transport, if not Sonia SA will not be held responsible for any replacement cost.

Please contact us via email:

sonia.export@sonia-sa.com (International)

sonia.nacional@sonia-sa.com (Spain/Portugal)

Many thanks for your kind cooperation,

Logistics department Sonia, S.A.

# GARANTÍAS DE TRANSPORTE

En Sonia tenemos verdadera obsesión por la calidad, y así implementamos estrictos seguimientos en cada uno de los procesos, desde la entrada de las materias primas en nuestros almacenes, hasta la salida del producto, adecuadamente embalado para garantizar que nuestros clientes sigan disfrutando de la belleza y calidad de nuestros productos.

Hay un tramo, durante el transporte, en el que necesitamos vuestra estrecha colaboración para poder seguir garantizándoos la máxima calidad del producto:

1. Necesitamos que observéis la mercancía a su recepción para aseguraros de que llegó en perfectas condiciones, en este único caso, si estáis completamente seguros de que la mercancía llegó perfecta, por favor, firmad el albarán de entrega sin reserva.
2. En caso de duda, o de no poder examinarlo adecuadamente, añadir en el albarán la frase "embalaje dañado".
3. En caso de daño, tenemos como máximo 48 horas para reclamar, en el albarán evidenciar "mercancía dañada/rota".

Con estos simples pasos las empresas de transporte o los seguros se harán cargo de cualquier desperfecto durante el traslado.

Por favor, contactad vía e-mail:

sonia.export@sonia-sa.com (Fuera de territorio español)

sonia.nacional@sonia-sa.com (En España)

Muchas gracias por vuestra colaboración,

Departamento Logística Sonia, S.A.

# SALES AND TERMS CONDITIONS

## **PRICES**

Prices are subjected to change without notice and are exclusive of any shipping, delivery, packaging or handling charges that may apply.

## **DELIVERIES**

Sonia S.A. will not be held responsible for delays in deliveries due to circumstances beyond its control such as fires, strikes, acts of nature, material shortages, accidents transportation delays, natural disasters or any other contingencies of such nature.

## **CLAIMS**

All claims are to be made within 30 days after receipt of goods. **NO CLAIM WILL BE ACCEPTED AFTER THE 30 DAYS DEADLINE.** It is your responsibility to inspect the products once received, especially when the product is going to a job site. Notify carrier immediately in writing and request an inspection report, which shows the exact procedures for filing a claim. Keep all packaging material until your claim has been settled. Sonia S.A. has packaged the material to exceed normal shipping requirements and will not be responsible for poorly packaged returned fixtures resulting in additional damages. **DO NOT RETURN ANY MATERIAL WITHOUT WRITTEN CONSENT** from Sonia S.A. Seller's responsibility ceases when the products are delivered in good conditions to the carrier.

Replacements will only be shipped ground. If any other special shipment is required, customer will be responsible for additional charges.

## **180 DAY RETURN POLICY**

Products may not be returned for credit or replacement without prior inspection and **WRITTEN AUTHORIZATION FROM Sonia S.A.** All R.G.A.'s must be requested in writing. The request must include P.O. number, invoice number (if available) and reason for return, after receiving your request, we will fax an approval that **MUST BE INCLUDED** with your return. Our restocking fee is 25%. In the event a product needs to be re-boxed for resale, we will charge a 15% net reboxing fee.

Orders including special order, project or display **CANNOT** be cancelled or returned.

## **WOOD PRODUCTS**

A majority of our products are crafted from noble woods and various finishes. Because of the natural variations inherent to this natural material, minor differences in the look and finish are expected and are not considered manufacturing defects. We cannot guarantee an exact match on any of our products.

# CONDICIONES GENERALES DE VENTA

1. Todos los pedidos se entenderán como compra en firme y estarán sujetos a la aprobación de nuestro Departamento Comercial.

2. El destinatario deberá comprobar que el material recibido, coincide con su pedido, y con el albarán que se adjunta. Así mismo deberá revisar que el material está en perfecto estado.

· Cualquier reclamación por rotura o daños en transporte deberá notificarse por escrito a Sonia, S.A. en las 24 horas siguientes a la entrega del material, de no ser así Sonia, S.A. no está obligada a reponer el material sin cargo.

· Las reclamaciones por diferencias en el material recibido, deberán realizarse en las 48 horas siguientes a la recepción del mismo.

3. Todos los pedidos superiores a 70€ se servirán a portes pagados.

Los pedidos inferiores a esta cantidad, quedarán retenidos hasta agruparlos a posteriores hasta superar el importe mínimo, a no ser que se indique lo contrario. De ser así irán cargados en factura 8€ en concepto de portes o enviados a portes debidos por la agencia que se nos indique.

Para el suministro de pedidos a portes pagados en Canarias:

- Tenerife y Las Palmas: Pedidos superiores a 1.000€
- Lanzarote, Fuerteventura e Islas Menores: Pedidos superiores a 1.500€
- Ceuta y Melilla: Pedidos superiores a 1.000€

Toda reclamación efectuada después de 8 días ajena a motivos imputables a Sonia, S.A. no será atendida.

4. Todas las facturas inferiores a 60€ se emitirán con vencimiento 15 días independientemente del plazo de pago habitual.

5. Los precios que aparecen en la tarifa no incluyen el I.V.A., se incrementarán en todas las facturas el régimen general.

6. Devoluciones: No se admitirán devoluciones de mercancías que no hayan sido previamente notificadas por escrito y autorizadas por nuestro Dpto. Comercial.

No se admitirán devoluciones de artículos especiales.

Las devoluciones autorizadas se realizarán a través de nuestro transportista habitual.

No se admitirán cargos de otra empresa de transportes que no sea la autorizada.

El cliente se hará cargo de las devoluciones originadas por motivos ajenos a Sonia, S.A., previa autorización de nuestro Dpto. Comercial pudiendo elegir la agencia de transportes que estime oportuno para realizar dicha devolución, asegurándose de que el producto esté en buenas condiciones y sea embalado correctamente para su transporte.

La mercancía deberá venir acompañada de una hoja con la relación del material autorizado; en caso contrario Sonia, S.A. podría no hacerse cargo de la mercancía.

Una vez recepcionada y aceptada, se expedirá la factura de abono correspondiente con una depreciación del 20% sobre el importe facturado, en concepto de manipulación, revisión y cambio de embalaje del producto devuelto, dicha cantidad será descontada en futuras compras.

7. Impagados:

Cualquier impagado que se produzca traerá como consecuencia la comunicación del mismo a nuestra compañía de Riesgo y la retención de los pedidos en curso hasta no tener cancelado dicho impagado.

Sonia, S.A. es el propietario de la mercancía hasta el pago completo de la misma.

8. Tribunales:

En caso de litigio ambas partes se someten a los tribunales de Valencia, rehusando a los que le correspondiesen por fuero propio.

9. Aceptación:

El hecho de cursar un pedido a Sonia, S.A. implica la aceptación de estas condiciones generales de venta.

10. Sonia, S.A. se reserva el derecho de modificar el diseño para mejora de sus productos.

11. Todos nuestros productos podrán ser modificados por exigencias de diseño y calidad sin previo aviso.

Toda la documentación fotográfica y/o diseño técnico reflejada en los folletos, catálogos y demás instrumentos publicitarios tienen valor indicativo, por lo que el cliente no podrá acogerse a ellos en caso de posibles quejas por disconformidad o diferencia con los productos suministrados siempre y cuando no afecte al uso que al que va destinado el producto. Todas las reclamaciones derivadas por este motivo, deberán realizarse con un plazo máximo de 7 días siguientes a la entrega de la mercancía en su lugar de destino.

Prices show in this catalogue are valid except for typographical errors.  
Los precios indicados en este catálogo son válidos salvo error tipográfico.

Edition 1.1  
Edición 1.1





SONIA  
Valencia - Spain  
[www.soniabath.com](http://www.soniabath.com)  
© 2022 Sonia, S.A.

CONTACT  
T. 96 317 10 68  
F. 96 317 11 61  
[sonia.nacional@soniabath.com](mailto:sonia.nacional@soniabath.com)

INTERNATIONAL  
T. +34 96 317 10 67  
F. +34 96 317 10 69  
[sonia.export@soniabath.com](mailto:sonia.export@soniabath.com)