

NATURAL CERAMIC · NATURAL CE
CERAMICA NATURALE · CERAMICA
CÉRAMIQUE NATURELLE · CÉRAMI
CERÁMICA NATURAL
NATURAL CERAMIC · NATURAL CE
CERAMICA NATURALE · CERAMICA
CÉRAMIQUE NATURELLE · CÉRAMI
CERÁMICA NATURAL · CERÁMICA N
NATURAL CERAMIC · NATURAL CE
CERAMICA NATURALE · CERAMICA
CÉRAMIQUE NATURELLE · CÉRAMI
CERÁMICA NATURAL · CERÁMICA N
NATURAL CERAMIC · NATURAL CE
CERAMICA NATURALE · CERAMICA
CÉRAMIQUE NATURELLE · CÉRAMI

NATUCER

CATÁLOGO GENERAL CATALOG 21/22

NATURAL CERAMIC · NATURAL C
CERAMICA NATURALE · CERAMICA
CÉRAMIQUE NATURELLE · CÉRAM
CERÁMICA NATURAL
NATURAL CERAMIC · NATURAL C
CERAMICA NATURALE · CERAMICA
CÉRAMIQUE NATURELLE · CÉRAM
CERAMICA NATURALE · CERAMICA
NATURAL CERAMIC · NATURAL CE
CERAMICA NATURALE · CERAMICA
CÉRAMIQUE NATURELLE · CÉRAM
CERÁMICA NATURAL · CERÁMICA
NATURAL CERAMIC · NATURAL C
CÉRAMIQUE NATURELLE · CÉRAM
CÉRAMIQUE NATURELLE · CÉRAM
CERÁMICA NATURAL · CERÁMICA
NATURAL CERAMIC · NATURAL C
CERAMICA NATURALE · CERAMICA
CÉRAMIQUE NATURELLE · CÉRAM

21
22

NATUCER



NATUCER

NATUCER, S.L. C/ Les Forques, 2 · 12200 Onda [Castellón] Spain · Apdo. nº 6
Tel.: + [34] 964 60 40 66 [8 líneas] · info@natucer.es · www.natucer.es

CATÁLOGO
GENERAL
CATALOG

NATUCER

CERÁMICA NATURAL



100% MADE IN SPAIN = 100% GARANTIA DE CALIDAD

100% MADE IN SPAIN = 100% QUALITY GUARANTEE

EVOLUTION
EXTRUDED PORCELAIN TILE

PORCELÁNICO
PORCELAIN TILE

White Body

ecoLinker

ANTI-BACTERIAL

www.natucer.es

NATUCER

SINCE 1989

Natucer inicia su andadura en la década de los 90, coincidiendo con el asentamiento de la revolución tecnológica española, ocurrida con la obtención de los revestimientos prensados con cocciones rápidas.

Ofrece soluciones en gres porcelánico extrusionado para interiores y exteriores.

Pavimentos que integran funcionalidad, máxima calidad y un diseño con esencia artesanal. Especialistas en todo tipo de piezas especiales que garantizan un acabado perfecto, como peldaños de gran formato o piezas específicas y técnicas para piscina.

Y revestimientos exclusivos al servicio de arquitectos, interioristas y decoradores sin limitaciones en cuanto a colores, formas, texturas, geometrías y volúmenes, para proyectos tanto residenciales como públicos o comerciales.



Natucer started out by the end of the 90's, matching up with the Spanish technological revolution and the production of pressed wall tiles through quick fire.

Gives you a lot of possibilities inside and outside porcelain tile.

Floor tiles that join the functionality with the maximum quality and a design with artisanal essence. Natucer is specialized in all type of special pieces to make a perfect finish, like large steps 48" or special technique pieces for pools. Wall tiles that have been created for architects and interior designers that looks unique and exclusive finishes, without limitation in colors, sizes, textures, 3Ds for all projects: residential, public and commercial.



PREOCUPADOS

La preocupación por el cuidado del entorno y la preservación del medioambiente han sido prioridad para la creación de esta nueva marca de la empresa Natucer.

La sostenibilidad de nuestro estilo de vida y su necesario equilibrio con el medioambiente necesita de hechos concretos y acciones tangibles. Natucer es responsable en el proceso de fabricación para minimizar su impacto en el medioambiente.

CONCERNED

Concern for the care of the environment and preservation of the environment has been a priority for the creation of this new brand The company Natucer.

The sustainability of our way of life and necessary balance to the environment needs concrete facts and tangible actions. Natucer is responsible for the manufacturing process to minimize their impact on the environment.

COMPROMETIDOS

Natucer se compromete con el cuidado del medioambiente y con los efectos que repercuten en el entorno debido a su actividad. Ha realizado importantes inversiones en infraestructura para adaptar y aplicar las mejoras técnicas y menos contaminantes en los procesos productivos. Algunos de los requisitos que se deben cumplir, entre otros, son: Vertidos, Emisiones atmosféricas y Gestión y procedimientos de residuos.

COMMITTED

Natucer is committed to caring for the environment and the effects that impact on the environment due to their activity. Has made significant investments in infrastructure to adapt and apply the best techniques and cleaner production processes. Some of the requirements to be met, among others are: Discharges. Atmospheric emissions. Waste management and procedures.



CONCIENCIA MEDIOAMBIENTAL
ENVIRONMENTAL AWARENESS

CONTAMINACIÓN ACÚSTICA REGULADA
REGULATED NOISE CONTAMINATION

CONTINUO RECICLAJE
CONTINUOUS RECYCLING



TRABAJO RESPONSABLE
RESPONSIBLE WORK

AHORRO ENERGÉTICO FUNDAMENTAL
FUNDAMENTAL ENERGY SAVINGS

EMISIONES ATMOSFÉRICAS CONTROLADAS
CONTROLLED ATMOSPHERIC EMISSIONS



UN PLANETA MÁS HABITABLE
MORE HABITABLE PLANET

GESTIÓN ADECUADA DE LOS RESIDUOS
CORRECT WASTE MANAGEMENT

VERTIDO CERO
ZERO WASTE

PIEZAS ESPECIALES

SPECIAL PIECES

Natucer cuenta con una gran variedad de piezas especiales que no sólo garantizan un acabado perfecto, sino que también permiten resolver estéticamente aspectos arquitectónicos como bordes de piscina o escaleras. Piezas diseñadas para lograr soluciones específicas para pavimentos exigentes. Natucer ofrece un pavimento ideal para emplazamientos arquitectónicos exteriores y zonas húmedas que precisen de exigentes prestaciones frente al deslizamiento. Pensado y fabricado para garantizar la máxima seguridad.

Natucer has a great variety of special pieces that not only guarantee a perfect finish, but also enables giving aesthetically ideas to architectural aspects such as edges of pool or stairs. Pieces designed to achieve specific solutions for specific floors. Natucer offers an ideal floor for humid areas and exterior architectural sites that require demanding benefits from sliding. Designed and manufactured to guarantee maximum safety.

STEP 120

25mm
ESPESOR
THICKNESS



BORDE DE PISCINA
30 x 36/4

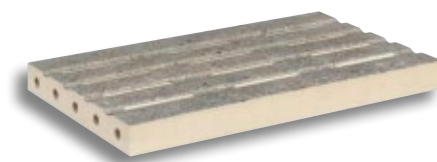

GRATING
19 x 30/2,2
18 x 36/2

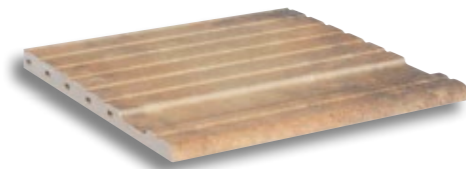

DESBORDANTE
30 x 30/2,2



REJILLA
12,5 x 30/2,2
12,5 x 60/2,2

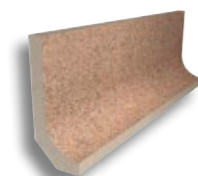

ZÓCALO ANGULAR
9,5 x 30 x 4



**ESQUINA EXTERIOR
ZÓCALO ANGULAR**
9,5 x 4



**ESQUINA INTERIOR
ZÓCALO ANGULAR**
9,5 x 4

ÁNGULO PELDAÑO CURVO 2PZ
33 x 46/4

ÁNGULO PELDAÑO CURVO 4PZ
33 x 33

ZÓCALO
9,8 x 120
9,8 x 60
9 x 36
9 x 30
9 x 25
9 x 22,5
7,5 x 80
7,5 x 60

PELDAÑO CURVO
36 x 33/4
30 x 33/4
25 x 33/4
22,5 x 33/4

VIERTE AGUAS
15 x 36/4
15 x 30/4
15 x 25/4
15 x 22,5/4

ZANQUÍN
9 x 36
9 x 30
9 x 25

ZANQUÍN 2,5
9 x 36
9 x 30

PELDAÑO ANGULAR
120 x 32/3
60 x 32/3

**REMATE PELDAÑO ANGULAR
IZQ. / DRCH.**
2,5 x 32

PELDAÑO ANGULAR
30 x 32/4
32 x 32/4

ÁNGULO PELDAÑO ANGULAR 2PZ
32 x 46/4

- PROBLEMAS + SOLUCIONES

- PROBLEMS + SOLUTIONS

MÚLTIPLES FORMATOS

MULTIPLE FORMATS

Natucer explora la geometría a través de sus diferentes formatos. Hexágonos y piezas irregulares que pasan a convivir con las formas tradicionales.

Piezas con mucho valor añadido ideales para propuestas de decoración que buscan la pureza de las líneas.

Natucer explores the geometry through different formats. Hexagons and irregular pieces that live together with traditional forms.

Pieces with added value ideal for decoration proposals seeking the purity of the lines.

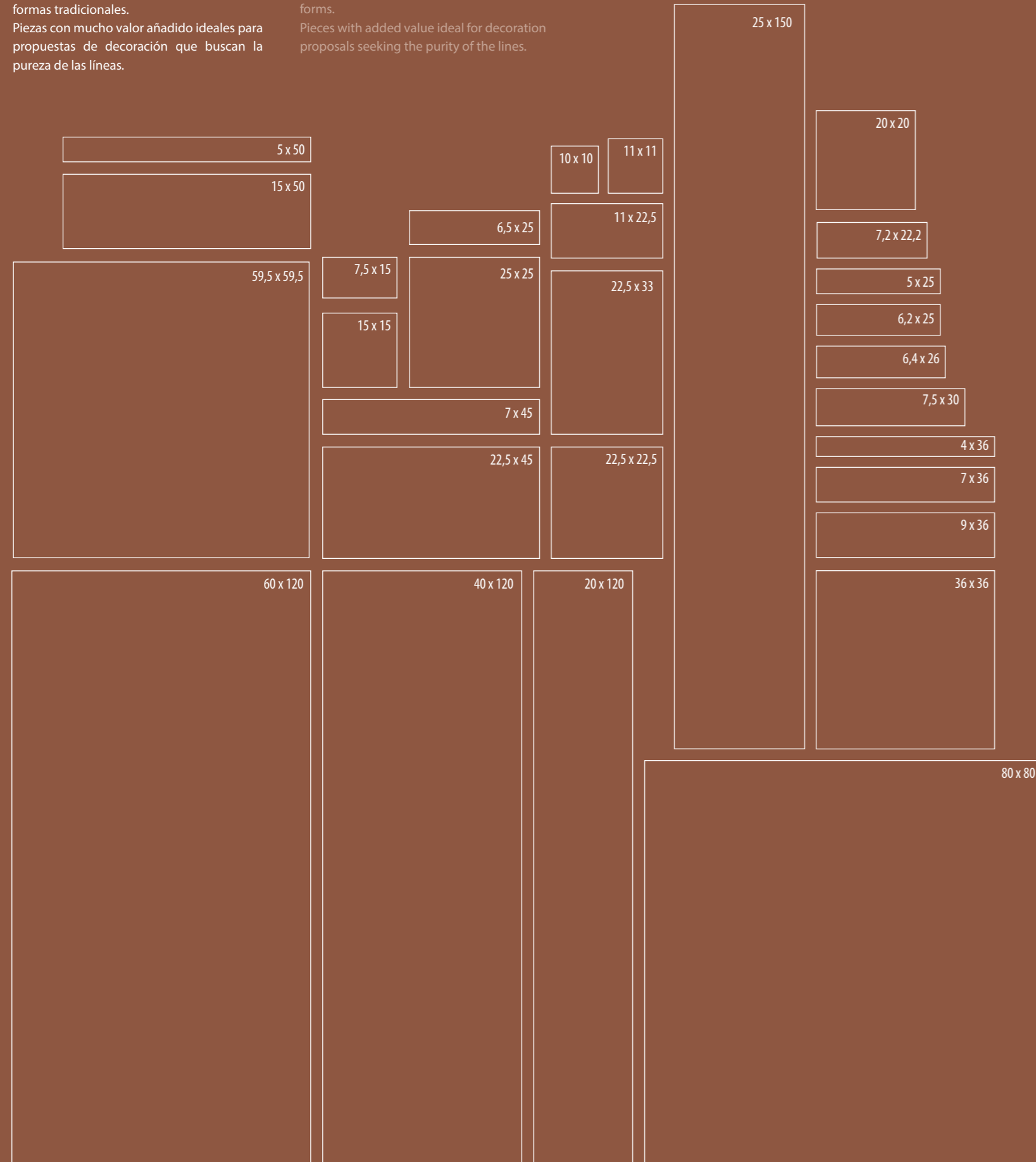

PIEZAS MODULARES

MODULAR PIECES



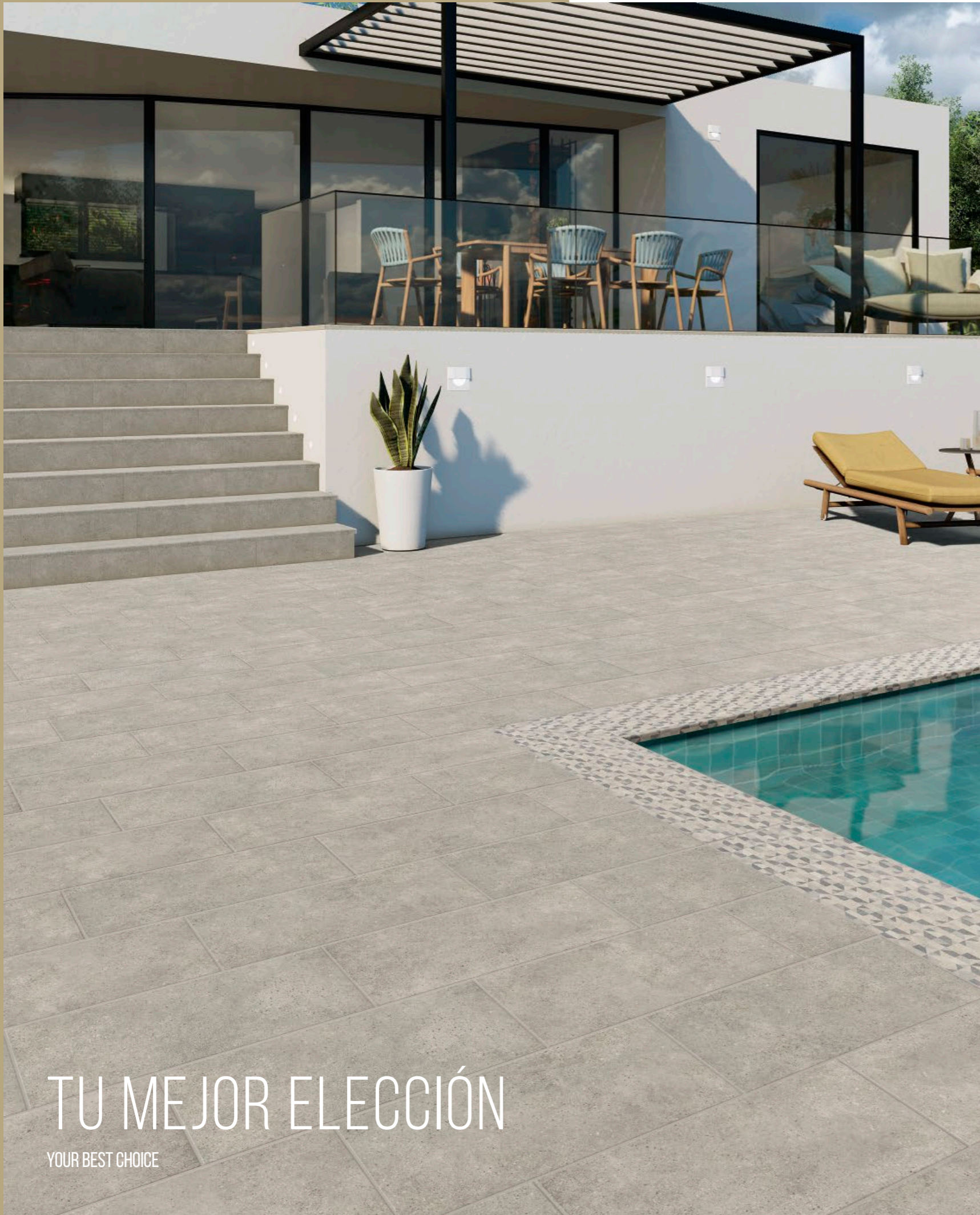

TU MEJOR ELECCIÓN

YOUR BEST CHOICE

VENTAJAS DE LA CERÁMICA

ADVANTAGES OF CERAMIC



HIGIÉNICA Y ANTIALERGÉNICA HYGIENIC AND ANTI-ALLERGENIC

La naturaleza inerte y el carácter impermeable de la cerámica permite prevenir la humedad, evitando el desarrollo de colonias de gérmenes y hongos.

The inert and impermeable nature of ceramic tiles helps to prevent damp from forming, a factor which contributes to the development of colonies of germs and fungi.



ESTÉTICA Y VERSÁTIL ESTHETIC AND VERSATILE

La cerámica es versátil y adaptable a cualquier superficie. Las diferentes posibilidades de colocación, sus texturas y volúmenes permiten diseñar libremente los espacios obteniendo resultados espectaculares.

Ceramic tiles are highly versatile and can be adapted to any surface. The various layout patterns, textures and volumes allow for a countless range of options and truly spectacular results.



IGNÍFUGA FIREPROOF

Es un material inerte e incombustible, creado a partir de arcilla.

La cerámica no se quema: es uno de los pocos materiales que, incluso en contacto directo con las llamas, no se quema, derrite, ni libera ninguna sustancia.

It is an inert, fireproof material made from sand and clay. Ceramic is one of the few materials that does not burn or release substances of any kind even when it comes into contact with a naked flame.



EFICIENCIA ENERGÉTICA ENERGY EFFICIENCY

La masa térmica inherente de los azulejos reduce el calentamiento y enfriamiento máximos, lo que ayuda a moderar los cambios de temperatura en los hogares.

The thermal mass inherent in the tiles, reduce the heating and cooling that help to moderate the change temperature in our house.



TRADICIÓN Y NATURAL TRADITION AND NATURE

Las piezas cerámicas sólo utilizan tres elementos básicos del medio ambiente: la tierra o la arcilla, el agua y el fuego.

Only three of nature's basic elements are used in the production of ceramic tiles: earth (clay), water and fire.



SEGURA SAFE

Estos productos no deslizan, son resistentes a las heladas, dificultan la adherencia de las manchas y ofrecen alta resistencia a golpes fuertes.

These products are non-slip, frost and stain resistant and are also highly resistant to heavy blows.



RESPONSABLE Y SOSTENIBLE RESPONSIBLE AND SUSTAINABLE

Es un material resistente al paso del tiempo, por lo que puede llegar a alcanzar ciclos de vida muy sostenibles. La industria está apostando por la investigación sobre reciclabilidad del material. El uso de cerámica en fachadas (fachadas ventiladas) y cubiertas consigue importantes ahorros energéticos.

They are highly resistant to wear and tear, and can therefore reach highly sustainable and lengthy life cycles. The industry is currently researching the recycling options this material offers. Furthermore, the use of ceramic tiles on façades (ventilated façades) and roofs guarantees major energy savings.



FÁCIL LIMPIEZA Y MANTENIMIENTO EASY CLEANING AND MAINTENANCE

La cerámica se caracteriza por su alta facilidad de limpieza y su capacidad de preservación frente a la suciedad y cualquier tipo de contaminación.

Ceramic tiles are easy to clean and are highly resistant to dirt and all types of contamination. In addition, the fact that ceramic is an electrical insulator means that the tiles repel electrically active atmospheric dust, thereby contributing to a more pleasant environment.



DURADERA Y RESISTENTE DURABLE AND RESISTANT

Su resistencia a los cambios bruscos de temperatura, a la humedad, a los agentes químicos y biológicos, así como su dureza y resistencia al rozamiento avalan su gran durabilidad en las edificaciones.

Ceramic tiles offer optimum levels of durability in buildings, thanks to their resistance to sudden temperature changes, damp and chemical and biological agents, as well as their hardness and scratch resistance.

SUELO ANTIDESLIZANTE
ANTISLIP FLOOR

FORMAS Y TEXTURAS
SHAPES AND TEXTURES

CON NATUCER, SIÉNTETE AUTOR DE TUS PROYECTOS WITH NATUCER, FEEL YOURSELF AS THE ARTIST OF YOUR PROJECTS

La cerámica se ha extendido por todo nuestro espacio. Sus propiedades de resistencia, versatilidad, seguridad y fácil mantenimiento además de ser antibacteriana e ignífuga han hecho que su zona de aplicación deje de limitarse a baños y cocinas.

Otra de sus ventajas es su capacidad de imitar otros materiales, que ni alcanzan las prestaciones que la cerámica ofrece ni son tan fáciles de mantener. Pudiendo así adaptarse a cualquier rincón del hogar, sea cual sea su estilo y con posibilidad de conseguir un interior coordinado con el exterior.

Tiles are all over our home. Its properties of resistance, versatility, safety and easy maintenance have made its application area no longer limited to bathrooms and kitchens.

The advantages of tiles are the ability to imitate other materials, which neither achieve the performance that ceramics offer and the easy maintain of the tiles. Thus being able to adapt to any corner of the home, whatever its style and with the possibility of achieving an interior coordinated with the outside.

BAÑO
BATHROOM

EFFECTOS ARTESANOS
ARTISAN EFFECTS

DORMITORIO
BEDROOM

POCELÁNICO METROTILE
BRICK PORCELAIN TILE

SUELOS ANTISLIP CLASE III-R11
ANTISLIP FLOORS CLASS III-R11

SISTEMA DESBORDANTE
OVERFLOW SYSTEM

PORCELÁNICO PARA EL INTERIOR DE LA PISCINA
PORCELAINIC TILES FOR THE INTERIOR OF THE POOL

SUELOS INTERIOR Y EXTERIOR
IN&OUT FLOORS

REVESTIMIENTO 3D, PORCELÁNICO EXTRUIDO
3D WALL TILES, EXTRUDED PORCELAIN

REVESTIMIENTO DE PASTA BLANCA
WALL TILES OF WHITE BODY

COCINA
KITCHEN

SUELO PORCELÁNICO CLASE I-R9
PORCELAIN TILE FLOOR CLASS I-R9

SALÓN
LIVINGROOM

PELDAÑO 120
STEP 120

INTERIORISMO Y ARQUITECTURA CONFORTABLE, SANA Y SEGURA

COMFORTABLE, HEALTHY AND SAFE INTERIOR DESIGN AND ARCHITECTURE

USO DEL CATÁLOGO

USE OF CATALOGUE

COLOR DE TIPOLOGÍA

- PAVIMENTO
Pavement
- REVESTIMIENTO
Coating

SIMBOLOGÍA

- Porcelánico
Porcelain Tile
- Gres extrusionado porcelánico
Porcelain extruded tile
- Pavimento de interior
Indoor floor tiles
- Pavimento Exterior
Outdoor floor tile
- Revestimiento
Wall tile
- Sin Mantenimiento
No maintenance
- Resistencia al rayado
Scratch resistance
- Resistente al desgaste
Wear resistance
- Resistente a la helada
Frost proof
- Resistencia a ácidos y bases
Resistance to acids and bases
- Superficie mate
Matt surface
- Superficie satinado
Glossy surface
- Superficie brillo
Surface brightness / shine
- Superficie semibrillo
Surface semi-gloss
- Destonificado Armonioso
Controlled destonification
- Modularidad
Modularity
- Rectificado
Rectified
- Diseños Diferentes
Different Designs
- Enmallado
On a mesh
- Antideslizante
Antislip
- Pintado a mano
Hand painted
- Enmallado pintado a mano
Hand painted on a mesh
- Volumen
Volume
- Bajo relieve
Under relief
- Tercer fuego
Third fire
- Barro
Quarry
- Producto envejecido
Old looking product
- Cola de milano - dovetail
Seguridad de agarre - Grip safety
- Bordas y Superficie Irregular
Irregular Edges and Surface

AMBIENTES DE LA SERIE



COLORES



GRADOS DE DESTONIFICACIÓN

Shade variation rating

- V1. Apariencia uniforme
V1. Uniform appearance
- V2. Variación leve
V2. Slight variation
- V3. Variación moderada
V3. Moderate variation
- V4. Variación sustancial
V4. Substantial variation

FORMATOS DISPONIBLES

Available sizes

20 x 60
TAMAÑO EN CENTÍMETROS
Size centimeters

(G 27)
CÓDIGO DE PRECIO
Price code

8" x 24"
TAMAÑO EN PULGADAS
Size inches

STOW DECOR

Disponibles en todos los colores - Available in all colors

4 TEXTURAS DIFERENTES - Se suministran mezcladas
4 DIFFERENT TEXTURES - Supplied mixed

DECORACIÓN
Decor

PIEZAS ESPECIALES
Special pieces

PACKING LIST

NOMBRE DE LA SERIE
Name of the serie

TIPOLOGÍA DE FABRICACIÓN
Type of manufacture

CARACTERÍSTICAS TÉCNICAS
Technical characteristics

slow

Pasta Blanca

RESISTENTE AL DESGASTE

SUPERFICIE BRILLO

ANTIDESLIZANTE

HECHO A MANO

60

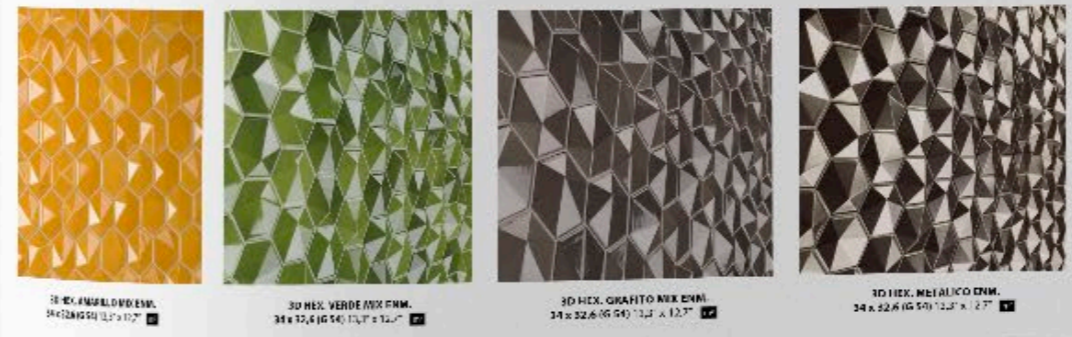
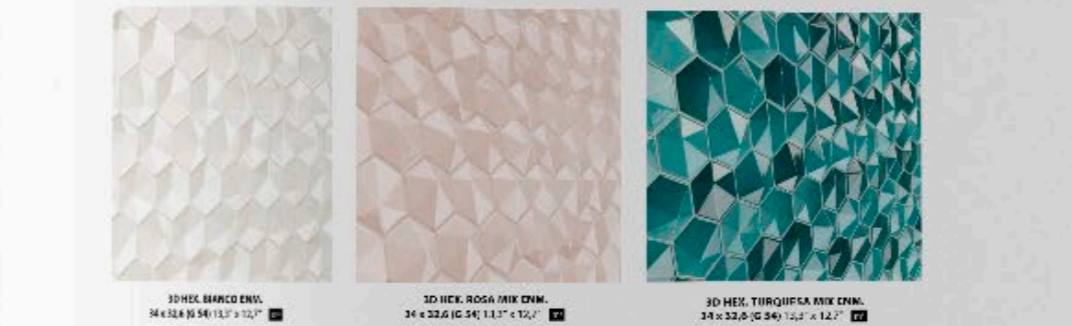

PACKING LIST

TIPO	PAQUETE	RENTA	M ²	CAMBIO	P. DIFERENCIAL	P. DIFERENCIAL
60x60	10	0,36	3,6	0,22	0,18	0,18
60x60	10	0,36	3,6	0,22	0,18	0,18
60x60	10	0,36	3,6	0,22	0,18	0,18

PACKING LIST

TIPO	PAQUETE	RENTA	M ²	CAMBIO	P. DIFERENCIAL	P. DIFERENCIAL
60x60	10	0,36	3,6	0,22	0,18	0,18
60x60	10	0,36	3,6	0,22	0,18	0,18
60x60	10	0,36	3,6	0,22	0,18	0,18

TIPOLOGÍA DE FABRICACIÓN

- ACABADO ESPECIAL PAVIMENTO EXTERIOR**
Is the finished special one for pavements of exterior
- ACABADO ESPECIAL PAVIMENTO INTERIOR**
Is the finished special one for pavements of interior
- DOS ACABADOS, MISMA SENSACIÓN ESTÉTICA**
Two finishes same aesthetic feeling
- IMPRESIÓN DIGITAL PARA EXTRUSIÓN**
Digital printing for Extrusión
- ANTIDESLIZANTE**
Antislip
- ANTIBACTERIANO**
Antibacterial
- PASTA BLANCA**
White body
- PORCELÁNICO EXTRUIDO**
Extruded porcelain tile
- PORCELÁNICO**
Porcelain tile
- PRODUCTO SE VENDE POR M2**
This product is sold per sqm
- PRODUCTO SE VENDE POR PIEZA**
This product is sold per piece
- HECHO A MANO**
Hand made

CARACTERÍSTICAS TÉCNICAS

- FUERZA DE ROTURA**
Breaking strength
- MANCHAS**
Staining
- CARGA DE ROTURA**
Breaking
- DILATACIÓN**
Dilatation
- RESISTE EL DESGASTE**
Wear resistance
- RESISTE LA FLEXIÓN**
Bending resistance
- RESISTE EL RAYADO**
Surface hardness
- ABSORCIÓN**
Water absorption
- ANTD.TORUS**
Antislip
- ANTIDESLIZANTE**
Antislip

NÚMERO DE PÁGINA

61

Page number

BOTANICA

IN RECTIFIED & OUTDOOR

PORCELÁNICO
PORCELAIN TILE

ANTI-BACTERIAL

Comfort floor
CLASE I - R 9
UNE 41901:2017 EX
DIN 51130:2014
BOTANICA ABEDUL - BOTANICA ALAMO
BOTANICA GREY - BOTANICA MAPLE

fine RESISTANCE
CLASE III - R 11
UNE 41901:2017 EX
DIN 51130:2014
BOTANICA GREY ANTISLIP
BOTANICA ALAMO ANTISLIP

FORMATO
25 x 150 - 10" x 60"

PORCELÁNICO RECTIFICADO DESTONIF. ARMONIOSO DISEÑOS DIFERENTES RESIST. A LA HELADA RESIST. A ÁCIDOS Y BASES SUPERFICIE MATE SIN MANTENIMIENTO



COLORES · COLORS



BOTANICA GREY
25 x 150 (G 79) 10" x 60"

BOTANICA GREY ANTISLIP
25 x 150 (G 80) 10" x 60"



BOTANICA ALAMO
25 x 150 (G 79) 10" x 60"

BOTANICA ALAMO ANTISLIP
25 x 150 (G 80) 10" x 60"



BOTANICA ABEDUL
25 x 150 (G 79) 10" x 60"



BOTANICA MAPLE
25 x 150 (G 79) 10" x 60"

PELDAÑO ANGULAR 120 STEP 120



PELDAÑO ANGULAR BOTANICA GREY
120 x 32/3 (G 72) 48" x 12,5"/1"
60 x 32/3 (G 73) 23,6" x 12,5"/1"



PELDAÑO ANGULAR BOTANICA ALAMO
120 x 32/3 (G 72) 48" x 12,5"/1"
60 x 32/3 (G 73) 23,6" x 12,5"/1"



PELDAÑO ANGULAR BOTANICA ABEDUL
120 x 32/3 (G 72) 48" x 12,5"/1"
60 x 32/3 (G 73) 23,6" x 12,5"/1"

Comfort floor ▶ R9 - Class I



PELDAÑO ANGULAR BOTANICA MAPLE
120 x 32/3 (G 72) 48" x 12,5"/1"
60 x 32/3 (G 73) 23,6" x 12,5"/1"

MARQUETRY VERSA-TILES DECOR STEP 120



PELDAÑO MARQUETRY PARK SPIKE
120 x 32/3 (G 72) 48" x 12,5"/1"
60 x 32/3 (G 73) 23,6" x 12,5"/1"

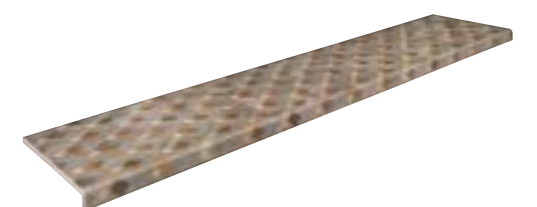

PELDAÑO MARQUETRY PARK INSET
120 x 32/3 (G 72) 48" x 12,5"/1"
60 x 32/3 (G 73) 23,6" x 12,5"/1"

PIEZAS ESPECIALES · SPECIAL PIECES

Disponibile en todos los colores · Available in all colors

fine RESISTANCE ▶ R11 - Class III

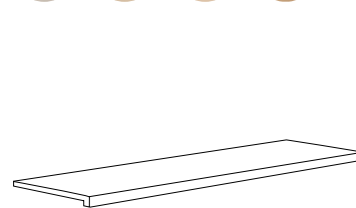

PELDAÑO ANGULAR ANTISLIP
120 x 32/3 (G 72) 48" x 12,5"/1"
60 x 32/3 (G 73) 23,6" x 12,5"/1"

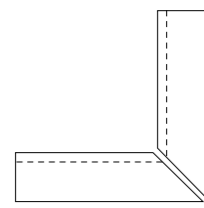

ÁNGULO PELDAÑO 120. INT ANTISLIP
120 x 32 x 45/3 (G 46 x 2)
48" x 12,5" x 17,7"/1"

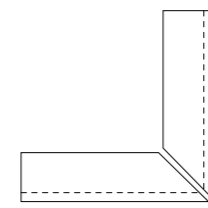

ÁNGULO PELDAÑO 120. EXT ANTISLIP
120 x 32 x 45/3 (G 46 x 2)
48" x 12,5" x 17,7"/1"

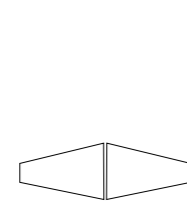

ÁNGULO PELDAÑO ANG. ANTISLIP
32 x 45/3 (G 18 x 2PZ)
12,5" x 17,7"/1"

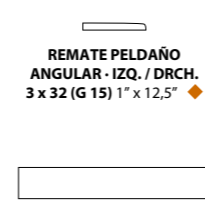

REMATE PELDAÑO ANGULAR - IZQ. / DRCH.
3 x 32 (G 15) 1" x 12,5"

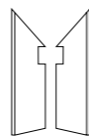

ZANQUÍN - IZQ. / DRCH.
10 x 30 (G 13) 4" x 11,8"

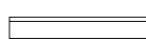

ZÓCALO
10 x 75 (G 17) 4" x 30"

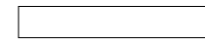

FRONTAL BOTANICA
15 x 120 (G 74) 6" x 48"

PACKING BASES

FORMATO	PULGADAS	PZ/CAJA	M ²	CAJA/PLT	PESO/CAJA	PESO/PLT
25 x 150	10" x 60"	4	1,5	40	35	1,430

PACKING PIEZAS ESPECIALES

FORMATO	PULGADAS	PZ/CAJA	ML	CAJA/PLT	PESO/CAJA	PESO/PLT
FRONTAL 15 x 120	6" x 48"	4	4,8	48	16,9	826
ZÓCALO 10 x 75	4" x 30"					
PELDAÑO ANG. 120 x 32/3	48" x 12,5"/1"	2	2,4	14	19,20	283,8
ANG. PELDAÑO 120 INT. 120 x 32 x 45/3	48" x 12,5" x 17,7"/1"	2	2,4	14	18	253
ANG. PELDAÑO 120 EXT. 120 x 32 x 45/3	48" x 12,5" x 17,7"/1"	2	2,4	14	18	253
ZANQUÍN 10 x 30	4" x 11,8"					
REMATE PELDAÑO 3 x 32	1" x 12,5"	20	6,4	60	3,5	219
ANG. PELD. ANG. 32 x 45/3	12,5" x 17,7"/1"	2	0,32	90	3,16	308

BOTANICA

OUTDOOR

EVOLUTION
EXTRUDED PORCELAIN TILE

fine RESISTANCE

CLASE III - R 11
UNE 41901:2017 EX
DIN 51130:2014

ANTI-BACTERIAL

FORMATO
21 x 89,5 · 8" x 35,2"

GRES EXTRUSIONADO PORCELÁNICO / PORCELAIN EXTRUDED TILE
DESTONIFICADO ARMONIOSO / CONTROLLED DESTONIFICATION
PAVIMENTO DE EXTERIOR / OUTDOOR FLOOR TILE
RESIST. A LA HELADA / FROST PROOF
RESIST. A ÁCIDOS Y BASES / RESIST. TO ACIDS & BASES
DISEÑOS DIFERENTES / DIFFERENT DESIGNS
SUPERFICIE MATE / MATT SURFACE
SIN MANTENIMIENTO / NO MAINTENANCE



COLORES · COLORS



BOTANICA GREY ANTISLIP
21 x 89,5 (G 70) 8" x 35,2" m²



BOTANICA ABEDUL ANTISLIP
21 x 89,5 (G 70) 8" x 35,2" m²



BOTANICA ALAMO ANTISLIP
21 x 89,5 (G 70) 8" x 35,2" m²



BOTANICA MAPLE ANTISLIP
21 x 89,5 (G 70) 8" x 35,2" m²

PELDAÑO ANGULAR 120 STEP 120

R11 - Class III



PELDAÑO ANGULAR BOTANICA GREY ANTISLIP
120 x 32/3 (G 72) 48" x 12,5"/1" ♦
60 x 32/3 (G 73) 23,6" x 12,5"/1" ♦



PELDAÑO ANGULAR BOTANICA ABEDUL ANTISLIP
120 x 32/3 (G 72) 48" x 12,5"/1" ♦
60 x 32/3 (G 73) 23,6" x 12,5"/1" ♦



PELDAÑO ANGULAR BOTANICA ALAMO ANTISLIP
120 x 32/3 (G 72) 48" x 12,5"/1" ♦
60 x 32/3 (G 73) 23,6" x 12,5"/1" ♦



PELDAÑO ANGULAR BOTANICA MAPLE ANTISLIP
120 x 32/3 (G 72) 48" x 12,5"/1" ♦
60 x 32/3 (G 73) 23,6" x 12,5"/1" ♦

PACKING BASES

FORMATO	PULGADAS	PZ/CAJA	M ²	CAJA/PLT	PESO/CAJA	PESO/PLT
21 x 89,5	8" x 35,2"	6	1,13	36	23,90	876

PACKING PIEZAS ESPECIALES

FORMATO	PULGADAS	PZ/CAJA	ML	CAJA/PLT	PESO/CAJA	PESO/PLT
REJILLA 12,5 x 30/2,2	4,9" x 11,8"/1"	6	3,6	66	16,55	1092
REJILLA 12,5 x 60/2,2	4,9" x 23,6"/1"	10	3	36	20,4	735
ESQ. REJILLA 12,5 x 12,5/2,2	4,9" x 4,9"/1"	24	3	66	18,24	1218
CANALETA 13 x 7,5 x 50	5" x 3" x 19,5"	24	12	20	13,5	300
CANALETA 20 x 14,5 x 50	8" x 5,7" x 19,5"	12	6	20	10,5	225

PACKING PIEZAS ESPECIALES

FORMATO	PULGADAS	PZ/CAJA	ML	CAJA/PLT	PESO/CAJA	PESO/PLT
FRONTAL 15 x 120	6" x 48"	4	4,8	48	16,9	826
ZÓCALO 10 x 75	4" x 30"					
PELDAÑO ANG. 120 x 32/3	48" x 12,5"/1"	2	2,4	14	19,20	283,8
PELDAÑO ANG. 60 x 32/3	23,6" x 12,5"/1"	2	1,2	28	9,60	284
ANG. PELDAÑO ANG. 32 x 45/3	12,5" x 17,7"/1"	2	0,32	90	3,16	308
ANG. PELDAÑO 120 EXT 120 x 32 x 45/3	48" x 12,5" x 17,7"/1"	2	2,4	14	18	253
ANG. PELDAÑO 120 INT 120 x 32 x 45/3	48" x 12,5" x 17,7"/1"	2	2,4	14	18	253
ZANQUÍN 10 x 30	4" x 11,8"					
REMATE PELDAÑO 3 x 32	1" x 12,5"	20	6,4	60	3,5	219

PIEZAS ESPECIALES · SPECIAL PIECES

Disponible en todos los colores · Available in all colors



Comfort floor



ZÓCALO
10 x 75 (G 17) 4" x 30" ♦



FRONTAL BOTANICA
15 x 120 (G 74) 6" x 48" ♦



ZANQUÍN - IZQ. / DRCH.
10 x 30 (G 13) 4" x 11,8" ♦

Disponible en todos los colores · Available in all colors



Disponible en todos los colores · Available in all colors



REJILLA
12,5 x 30/2,2 (G 57) 4,9" x 11,8"/1" ♦
12,5 x 60/2,2 (G 59) 4,9" x 23,6"/1" ♦



ÁNGULO PELDAÑO 120. INT ANTISLIP
120 x 32 x 45/3 (G 46 x 2) ♦
48" x 12,5" x 17,7"/1" ♦



ÁNGULO PELDAÑO 120. EXT ANTISLIP
120 x 32 x 45/3 (G 46 x 2) ♦
48" x 12,5" x 17,7"/1" ♦



CANALETA (blanco)
13 x 7,5 x 50 (G 30) 5" x 3" x 19,5" ♦
20 x 14,5 x 50 (G 19) 8" x 5,7" x 19,5" ♦



ESQUINA REJILLA
12,5 x 12,5/2,2 (G 19) ♦
4,9" x 4,9"/1" ♦



REMATE PELDAÑO ANGULAR - IZQ. / DRCH.
3 x 32 (G 15) 1" x 12,5" ♦



ÁNGULO PELDAÑO ANG. ANTISLIP
32 x 45/3 (G 18 x 2PZ) ♦
12,5" x 17,7"/1" ♦

NATURA

IN RECTIFIED & OUTDOOR

PORCELÁNICO
PORCELAIN TILE

ANTI-BACTERIAL

RESISTE LA FLEXIÓN	RESISTE EL DESGASTE	RESISTE EL RAYADO	ANTIDESLIZANTE	MANCHAS	ABSORCIÓN	CARGA DE ROTURA
59 N/mm2	PEI II-IV	MOHS - 7	Class I - R9	Class 5 - Class A	0,1%	3765 Nw
59 N/mm2	PEI IV	MOHS - 7	Class III - R11	Class 5 - Class A	0,1%	3765 Nw
						INTERIOR
						EXTERIOR

Comfort floor

CLASE I - R 9
UNE 41901:2017 EX
DIN 5130:2014

CLASE III - R 11
UNE 41901:2017 EX
DIN 5130:2014

NATURA WHITE - NATURA SAND
NATURA CAMEL - NATURA UMBER

fine RESISTANCE

NATURA WHITE ANTISLIP
NATURA CAMEL ANTISLIP

- PORCELÁNICO PORCELAIN TILE
- RECTIFICADO RECTIFIED
- DESTONIF. ARMONIOSO CONTROLLED DESTONIF.
- DISEÑOS DIFERENTES DIFFERENT DESIGNS
- RESIST. A LA HELADA FROST PROOF
- RESIST. A ÁCIDOS Y BASES RESIST. TO ACIDS & BASES
- SUPERFICIE MATE MATT SURFACE
- SIN MANTENIMIENTO NO MAINTENANCE



COLORES · COLORS



NATURA WHITE
20 x 120 (G 68) 8" x 48" m

NATURA WHITE ANTISLIP
20 x 120 (G 70) 8" x 48" m



NATURA SAND
20 x 120 (G 68) 8" x 48" m



NATURA CAMEL
20 x 120 (G 68) 8" x 48" m

NATURA CAMEL ANTISLIP
20 x 120 (G 70) 8" x 48" m



NATURA UMBER
20 x 120 (G 68) 8" x 48" m

PELDAÑO ANGULAR 120 STEP 120



PELDAÑO ANGULAR NATURA WHITE
120 x 32/3 (G 72) 48" x 12,5"/1" ♦
60 x 32/3 (G 73) 23,6" x 12,5"/1" ♦



PELDAÑO ANGULAR NATURA SAND
120 x 32/3 (G 72) 48" x 12,5"/1" ♦
60 x 32/3 (G 73) 23,6" x 12,5"/1" ♦



PELDAÑO ANGULAR NATURA CAMEL
120 x 32/3 (G 72) 48" x 12,5"/1" ♦
60 x 32/3 (G 73) 23,6" x 12,5"/1" ♦



PELDAÑO ANGULAR NATURA UMBER
120 x 32/3 (G 72) 48" x 12,5"/1" ♦
60 x 32/3 (G 73) 23,6" x 12,5"/1" ♦

MARQUETRY VERSA-TILES DECOR STEP 120



PELDAÑO MARQUETRY PARK SPIKE
120 x 32/3 (G 72) 48" x 12,5"/1" ♦
60 x 32/3 (G 73) 23,6" x 12,5"/1" ♦

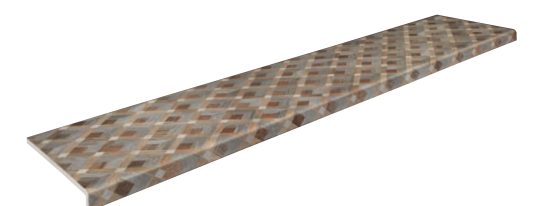

PELDAÑO MARQUETRY PARK INSET
120 x 32/3 (G 72) 48" x 12,5"/1" ♦
60 x 32/3 (G 73) 23,6" x 12,5"/1" ♦

PIEZAS ESPECIALES · SPECIAL PIECES

Disponible en todos los colores · Available in all colors

fine RESISTANCE ▶ R11 - Class III

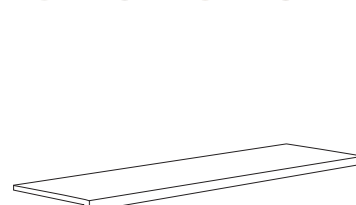

PELDAÑO ANGULAR ANTISLIP
120 x 32/3 (G 72) 48" x 12,5"/1" ♦
60 x 32/3 (G 73) 23,6" x 12,5"/1" ♦

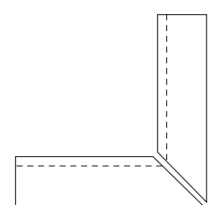

ÁNGULO PELDAÑO 120. INT ANTISLIP
120 x 32 x 45/3 (G 46 x 2) 48" x 12,5" x 17,7"/1" ♦

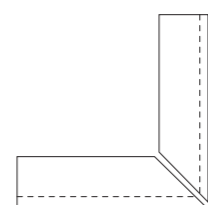

ÁNGULO PELDAÑO 120. EXT ANTISLIP
120 x 32 x 45/3 (G 46 x 2) 48" x 12,5" x 17,7"/1" ♦

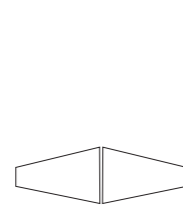

ÁNGULO PELDAÑO ANG. ANTISLIP
32 x 45/3 (G 18 x 2PZ) 12,5" x 17,7"/1" ♦

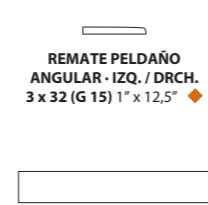

FRONTAL
15 x 120 (G 74) 6" x 48" ♦

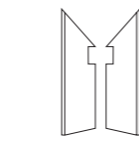

ZANQUÍN - IZQ. / DRCH.
9,8 x 30 (G 12) 3,9" x 11,8" ♦

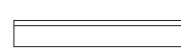

ZÓCALO
9,8 x 120 (G 74) 3,9" x 48" ♦
9,8 x 60 (G 75) 3,9" x 23,6" ♦

Comfort floor ▶ R9 - Class I

PACKING BASES

FORMATO	PULGADAS	PZ/CAJA	M ²	CAJA/PLT	PESO/CAJA	PESO/PLT
20 x 120	8" x 48"	5	1,2	48	25	1,140

PACKING PIEZAS ESPECIALES

FORMATO	PULGADAS	PZ/CAJA	ML	CAJA/PLT	PESO/CAJA	PESO/PLT
FRONTAL 15 x 120	6" x 48"	4	4,8	48	16,9	826
ZÓCALO 9,8 x 120	3,9" x 48"	8	9,6	63	22	1400
ZÓCALO 9,8 x 60	3,9" x 23,6"	16	9,6	72	21,9	1591
PELDAÑO ANG. 120 x 32/3	48" x 12,5"/1"	2	2,4	14	19,20	284
ANG. PELDAÑO 120 INT. 120 x 32 x 45/3	48" x 12,5" x 17,7"/1"	2	2,4	14	18	253
ANG. PELDAÑO 120 EXT. 120 x 32 x 45/3	48" x 12,5" x 17,7"/1"	2	2,4	14	18	253
PELDAÑO ANG. 60 x 32/3	23,6" x 12,5"/1"	2	1,2	28	9,60	284
ZANQUÍN 9,8 x 30	3,9" x 11,8"	30	9	48	16,24	794
REMATE PELDAÑO 3 x 32	1" x 12,5"	20	6,4	60	3,5	219
ANG. PELD. ANG. 32 x 45/3	12,5" x 17,7"/1"	2	0,32	90	3,20	300

NATURA

OUTDOOR

EVOLUTION
EXTRUDED PORCELAIN TILE

fine RESISTANCE

CLASE III - R 11
UNE 41901:2017 EX
DIN 51130:2014

ANTI-BACTERIAL

FORMATO
21 x 89,5 · 8" x 35,2"

GRES EXTRUSIONADO PORCELÁNICO / PORCELAIN EXTRUDED TILE
DESTONIFICADO ARMONIOSO / CONTROLLED DESTONIFICATION
PAVIMENTO DE EXTERIOR / OUTDOOR FLOOR TILE
RESIST. A LA HELADA / FROST PROOF
RESIST. A ÁCIDOS Y BASES / RESIST. TO ACIDS & BASES
DISEÑOS DIFERENTES / DIFFERENT DESIGNS
SUPERFICIE MATE / MATT SURFACE
SIN MANTENIMIENTO / NO MAINTENANCE



COLORES · COLORS



NATURA WHITE ANTISLIP
21 x 89,5 (G 70) 8" x 35,2" m²



NATURA CAMEL ANTISLIP
21 x 89,5 (G 70) 8" x 35,2" m²



NATURA SAND ANTISLIP
21 x 89,5 (G 70) 8" x 35,2" m²



NATURA UMBER ANTISLIP
21 x 89,5 (G 70) 8" x 35,2" m²

PELDAÑO ANGULAR 120 STEP 120

R11 - Class III



PELDAÑO ANGULAR NATURA WHITE ANTISLIP
120 x 32/3 (G 72) 48" x 12,5"/1" ♦
60 x 32/3 (G 73) 23,6" x 12,5"/1" ♦



PELDAÑO ANGULAR NATURA SAND ANTISLIP
120 x 32/3 (G 72) 48" x 12,5"/1" ♦
60 x 32/3 (G 73) 23,6" x 12,5"/1" ♦



PELDAÑO ANGULAR NATURA CAMEL ANTISLIP
120 x 32/3 (G 72) 48" x 12,5"/1" ♦
60 x 32/3 (G 73) 23,6" x 12,5"/1" ♦



PELDAÑO ANGULAR NATURA UMBER ANTISLIP
120 x 32/3 (G 72) 48" x 12,5"/1" ♦
60 x 32/3 (G 73) 23,6" x 12,5"/1" ♦

PIEZAS ESPECIALES · SPECIAL PIECES

Disponible en todos los colores · Available in all colors



Comfort floor

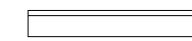

ZÓCALO
9,8 x 60 (G 75) 3,9" x 23,6" ♦



FRONTAL
15 x 120 (G 74) 6" x 48" ♦

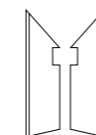

ZANQUÍN · IZQ. / DRCH.
9,8 x 30 (G 12) 3,9" x 11,8" ♦

Disponible en todos los colores · Available in all colors

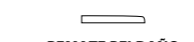
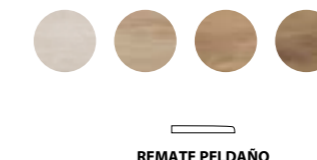

REMATE PELDAÑO
ANGULAR · IZQ. / DRCH.
3 x 32 (G 15) 1" x 12,5" ♦

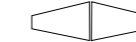

ÁNGULO PELDAÑO ANG.
32 x 45/3 (G 18 x 2PZ) 12,5" x 17,7"/1" ♦

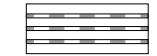

REJILLA
12,5 x 30/2,2 (G 57) 4,9" x 11,8"/1" ♦
12,5 x 60/2,2 (G 59) 4,9" x 23,6"/1" ♦



ESQUINA REJILLA
12,5 x 12,5/2,2 (G 19)
4,9" x 4,9"/1" ♦

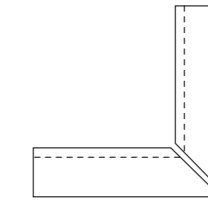

ÁNGULO PELDAÑO 120. INT
120 x 32 x 45/3 (G 46 x 2)
48" x 12,5" x 17,7"/1" ♦

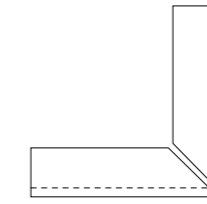

ÁNGULO PELDAÑO 120. EXT
120 x 32 x 45/3 (G 46 x 2)
48" x 12,5" x 17,7"/1" ♦

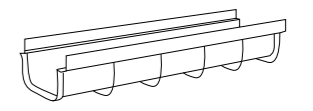

CANALETA (blanco)
13 x 7,5 x 50 (G 30) 5" x 3" x 19,5" ♦
20 x 14,5 x 50 (G 19) 8" x 5,7" x 19,5" ♦

PACKING BASES

FORMATO	PULGADAS	PZ/CAJA	M ²	CAJA/PLT	PESO/CAJA	PESO/PLT
21 x 89,5	8" x 35,2"	6	1,13	36	23,90	876

PACKING PIEZAS ESPECIALES

FORMATO	PULGADAS	PZ/CAJA	ML	CAJA/PLT	PESO/CAJA	PESO/PLT
FRONTAL 15 x 120	6" x 48"	4	4,8	48	16,9	826
ZÓCALO 9,8 x 60	3,9" x 23,6"	16	9,6	72	21,9	1591
PELDAÑO ANG. 120 x 32/3	48" x 12,5"/1"	2	2,4	14	19,20	284
PELDAÑO ANG. 60 x 32/3	23,6" x 12,5"/1"	2	1,2	28	9,60	284
ANG. PELDAÑO ANG. 32 x 45/3	12,5" x 17,7"/1"	2	2,4	14	18	253
ANG. PELDAÑO 120 EXT/INT 120 x 32 x 45/3	48" x 12,5" x 17,7"/1"	2	0,32	90	3,2	300
ZANQUÍN 9,8 x 30	3,9" x 11,8"	30	9	48	16,24	794
REMATE PELDAÑO 3 x 32	1" x 12,5"	20	6,4	60	3,5	219

PARK

IN RECTIFIED & OUTDOOR

PORCELÁNICO
PORCELAIN TILE

ANTI-BACTERIAL

RESISTE LA FLEXIÓN	RESISTE EL DESGASTE	RESISTE EL RAYADO	ANTIDESLIZANTE	MANCHAS	ABSORCIÓN	CARGA DE ROTURA	
59 N/mm2	PEI II-IV	MOHS-7	Class I - R9	Class 5 - Class A	0,1%	3765 Nw	INTERIOR
59 N/mm2	PEI IV	MOHS-7	Class III - R11	Class 5 - Class A	0,1%	3765 Nw	EXTERIOR

Comfort floor

CLASE I - R9
UNE: 41901:2017 EX
DIN 51130:2014

CENTRAL PARK - STANLEY PARK
RETIRO PARK - HYDE PARK

fine RESISTANCE

CLASE III - R11
UNE: 41901:2017 EX
DIN 51130:2014

CENTRAL PARK ANTIDESLIZANTE
HYDE PARK ANTIDESLIZANTE

- PORCELÁNICO PORCELAIN TILE
- RECTIFICADO RECTIFIED
- DESTONIF. ARMONIOSO CONTROLLED DESTONIF.
- DISEÑOS DIFERENTES DIFFERENT DESIGNS
- RESIST. A LA HELADA FROST PROOF
- RESIST. A ÁCIDOS Y BASES RESIST. TO ACIDS & BASES
- SUPERFICIE MATE MATT SURFACE
- SIN MANTENIMIENTO NO MAINTENANCE



COLORES · COLORS

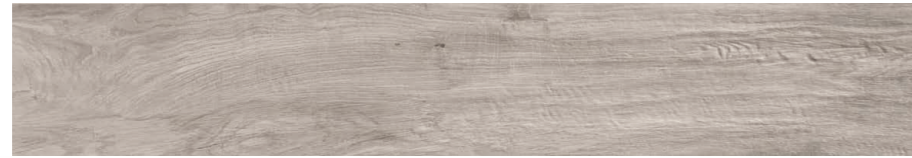

CENTRAL PARK
20 x 120 (G 68) 8" x 48"

CENTRAL PARK ANTISLIP
20 x 120 (G 70) 8" x 48"



STANLEY PARK
20 x 120 (G 68) 8" x 48"



HYDE PARK
20 x 120 (G 68) 8" x 48"

HYDE PARK ANTISLIP
20 x 120 (G 70) 8" x 48"



RETIRO PARK
20 x 120 (G 68) 8" x 48"

ENMALLADOS · ON A MESH

Disponible en todos los colores · Available in all colors



FRONTAL MOSAICO TIRA PARK
15 x 30 (G 16) 5,9" x 11,8"

CENTRO MOSAICO TIRA PARK
30 x 30 (G 18) 11,8" x 11,8"

Disponible también en MIX HYDE/RETIRO · Available in MIX HYDE/RETIRO



FRONTAL MOSAICO TACO PARK
MIX CENTRAL/STANLEY
15 x 30 (G 16) 5,9" x 11,8"

CENTRO MOSAICO TACO PARK
MIX CENTRAL/STANLEY
30 x 30 (G 18) 11,8" x 11,8"

Disponible en todos los colores · Available in all colors



FRONTAL MOSAICO TACO PARK
15 x 30 (G 16) 5,9" x 11,8"

CENTRO MOSAICO TACO PARK
30 x 30 (G 18) 11,8" x 11,8"

Disponible también en MIX CENTRAL/STANLEY · Available in MIX CENTRAL/STANLEY

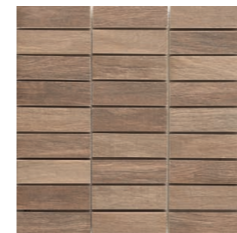

FRONTAL MOSAICO TIRA PARK
MIX HYDE/RETIRO
15 x 30 (G 16) 5,9" x 11,8"

CENTRO MOSAICO TIRA PARK
MIX HYDE/RETIRO
30 x 30 (G 18) 11,8" x 11,8"

MARQUETRY

VERSA-TILES DECOR STEP 120

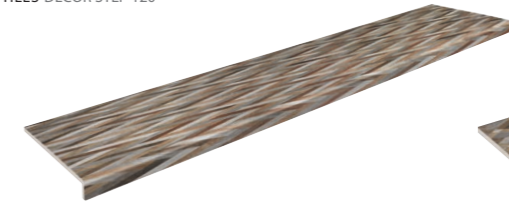

PELDAÑO MARQUETRY PARK SPIKE
120 x 32/3 (G 72) 48" x 12,5"/1"

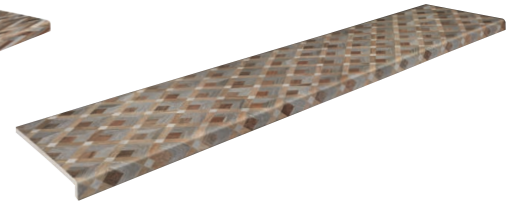

PELDAÑO MARQUETRY PARK INSET
120 x 32/3 (G 72) 48" x 12,5"/1"

PIEZAS ESPECIALES · SPECIAL PIECES

Disponible en todos los colores · Available in all colors



fine RESISTANCE ▶ R11 - Class III

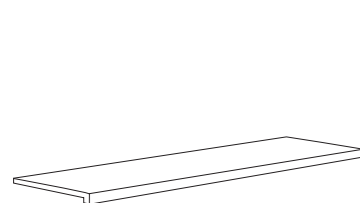

PELDAÑO ANGULAR ANTISLIP
120 x 32/3 (G 72) 48" x 12,5"/1"

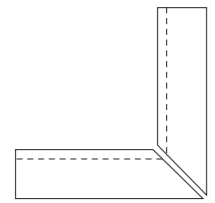

ÁNGULO PELDAÑO 120. INT ANTISLIP
120 x 32 x 45/3 (G 46 x 2)
48" x 12,5" x 17,7"/1"

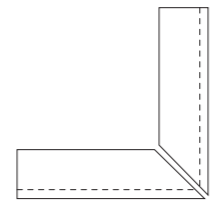

ÁNGULO PELDAÑO 120. EXT ANTISLIP
120 x 32 x 45/3 (G 46 x 2)
48" x 12,5" x 17,7"/1"

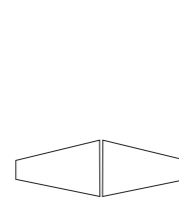

ÁNGULO PELDAÑO ANG. ANTISLIP
32 x 45/3 (G 18 x 2PZ)
12,5" x 17,7"/1"

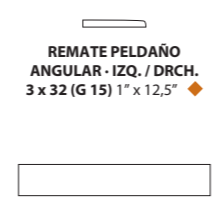

REMATE PELDAÑO ANGULAR - IZQ. / DRCH.
3 x 32 (G 15) 1" x 12,5"

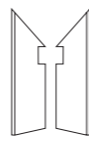

ZANQUÍN - IZQ. / DRCH.
9,8 x 30 (G 12) 3,9" x 11,8"



FRONTAL
15 x 120 (G 74) 6" x 48"

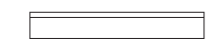

ZÓCALO
9,8 x 120 (G 74) 3,9" x 48"

PACKING BASES

FORMATO	PULGADAS	PZ/CAJA	M ²	CAJA/PLT	PESO/CAJA	PESO/PLT
20 x 120	8" x 48"	5	1,2	48	25	1.140
ENM. FRONTAL 15 x 30	5,9" x 11,8"	15	0,68	60	14,95	912
ENM. CENTRO 30 x 30	11,8" x 11,8"	11	1	72	21,85	1.590

PACKING PIEZAS ESPECIALES

FORMATO	PULGADAS	PZ/CAJA	ML	CAJA/PLT	PESO/CAJA	PESO/PLT
FRONTAL 15 x 120	6" x 48"	4	4,8	48	16,9	826
ZÓCALO 9,8 x 120	3,9" x 48"	8	9,6	63	22	1400
ZÓCALO 9,8 x 60	3,9" x 23,6"	16	9,6	72	21,9	1591
PELDAÑO ANG. 120 x 32/3	48" x 12,5"/1"	2	2,4	14	19,20	284
ANG. PELDAÑO 120 INT. 120 x 32 x 45/3	48" x 12,5" x 17,7"/1"	2	2,4	14	18	253
ANG. PELDAÑO 120 EXT. 120 x 32 x 45/3	48" x 12,5" x 17,7"/1"	2	2,4	14	18	253
PELDAÑO ANG. 60 x 32/3	23,6" x 12,5"/1"	2	1,2	28	9,60	284
ZANQUÍN 9,8 x 30	3,9" x 11,8"	30	9	48	16,24	794
REMATE PELDAÑO 3 x 32	1" x 12,5"	20	6,4	60	3,5	219
ANG. PELDAÑO ANG. 32 x 45/3	12,5" x 17,7"/1"	2	0,32	90	3,46	325

PARK

OUTDOOR

EVOLUTION
EXTRUDED PORCELAIN TILE

fine RESISTANCE

CLASE III - R 11
UNE. 41901:2017 EX
DIN 51130:2014

ANTI-BACTERIAL

FORMATO
21 x 89,5 - 8" x 35,2"

GRES EXTRUSIONADO PORCELÁNICO / PORCELAIN EXTRUDED TILE
DESTONIFICADO ARMONIOSO / CONTROLLED DESTONIFICATION
PAVIMENTO DE EXTERIOR / OUTDOOR FLOOR TILE
RESIST. A LA HELADA / FROST PROOF
RESIST. A ÁCIDOS Y BASES / RESIST. TO ACIDS & BASES
DISEÑOS DIFERENTES / DIFFERENT DESIGNS
SUPERFICIE MATE / MATT SURFACE
SIN MANTENIMIENTO / NO MAINTENANCE



COLORES · COLORS



HYDE PARK ANTISLIP
21 x 89,5 (G 70) 8" x 35,2" m²



CENTRAL PARK ANTISLIP
21 x 89,5 (G 70) 8" x 35,2" m²



RETIRO PARK ANTISLIP
21 x 89,5 (G 70) 8" x 35,2" m²



STANLEY PARK ANTISLIP
21 x 89,5 (G 70) 8" x 35,2" m²

PIEZAS ESPECIALES · SPECIAL PIECES
Disponible en CENTRAL PARK y HYDE PARK
Available in CENTRAL PARK & HYDE PARK

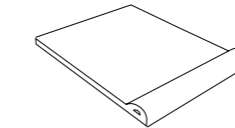

BORDE PISCINA
30 x 36/4 (G 19) 11,8" x 14"/1,5" ♦

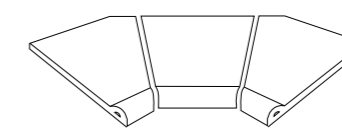

BORDE PISCINA ESQ. INT.
51,2 x 51,2/4 (G 62 x juego)
20,1" x 20,1"/1,5" ♦

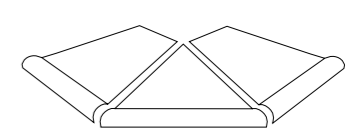

BORDE PISCINA ESQ. EXT.
51,2 x 51,2/4 (G 62 x juego)
20,1" x 20,1"/1,5" ♦

Disponible en STANLEY PARK
Available in STANLEY PARK



DESBORDANTE
30 x 30/2,2 (G 17) 11,8" x 11,8"/1" ♦

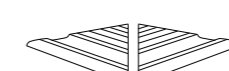

ESQ. EXT. DESBORDANTE
30 x 30 x 41,5/2,2 (G 19 x 2)
11,8" x 11,8" x 16"/1" ♦



ESQ. INT. DESBORDANTE
30 x 30 x 41,5/2,2 (G 18)
11,8" x 11,8" x 16"/1" ♦



GRATTING
19 x 30/2,2 (G 18)
7" x 11,8"/1" ♦

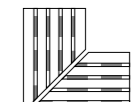

ESQUINA GRATTING
30 x 19 x 25,5/2,2 (G 20 x 2)
11,8" x 7" x 10"/1" ♦

Disponible en todos los colores · Available in all colors

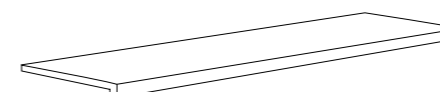

PELDAÑO ANGULAR
120 x 32/3 (G 72) 48" x 12,5"/1" ♦
60 x 32/3 (G 73) 23,6" x 12,5"/1" ♦

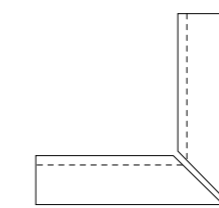

ÁNGULO PELDAÑO 120. INT
120 x 32 x 45/3 (G 46 x 2)
48" x 12,5" x 17,7"/1" ♦

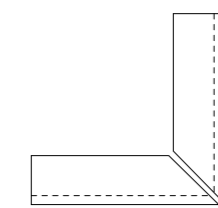

ÁNGULO PELDAÑO 120. EXT
120 x 32 x 45/3 (G 46 x 2)
48" x 12,5" x 17,7"/1" ♦



ÁNGULO PELDAÑO ANG.
32 x 45/3 (G 18 x 2P2) 12,5" x 17,7"/1" ♦



CANALETA (blanco)
13 x 7,5 x 50 (G 30) 5" x 3" x 19,5" ♦
20 x 14,5 x 50 (G 19) 8" x 5,7" x 19,5" ♦



REJILLA
12,5 x 30/2,2 (G 57) 4,9" x 11,8"/1" ♦
12,5 x 60/2,2 (G 59) 4,9" x 23,6"/1" ♦



ESQUINA REJILLA
12,5 x 12,5/2,2 (G 19) 4,9" x 4,9"/1" ♦

Disponible en todos los colores · Available in all colors

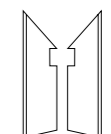

ZANQUÍN · IZQ. / DRCH.
9,8 x 30 (G 12) 3,9" x 11,8" ♦

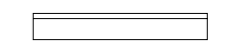

ZÓCALO
9,8 x 60 (G 75) 3,9" x 23,6" ♦

PACKING BASES

FORMATO	PULGADAS	PZ/CAJA	M ²	CAJA/PLT	PESO/CAJA	PESO/PLT
21 x 89,5	8" x 35,2"	6	1,13	36	23,90	876

PACKING PIEZAS ESPECIALES

FORMATO	PULGADAS	PZ/CAJA	ML	CAJA/PLT	PESO/CAJA	PESO/PLT
DESBORDANTE 30 x 30/2,2	11,8" x 11,8"/1	6	1,8	44	17,75	795
ESQ. EXT. DESB. 30 x 30 x 41,5/2,2	11,8" x 11,8" x 16"/1	2	0,33	90	3,8	357
ESQ. INT. DESB. 30 x 30 x 41,5/2,2	11,8" x 11,8" x 16"/1	2	0,33	90	3,8	357
GRATTING 19 x 30/2,2	7" x 11,8"/1	8	2,4	56	19,54	1109
ESQ. GRATTING 30 x 19 x 25,5/2,2	11,8" x 7" x 10"/1	8	2,16	56	14,30	815

PACKING PIEZAS ESPECIALES

FORMATO	PULGADAS	PZ/CAJA	ML	CAJA/PLT	PESO/CAJA	PESO/PLT
ZÓCALO 9,8 x 60	3,9" x 23,6"	16	9,6	72	21,9	1591
PELDAÑO ANG. 120 x 32/3	48" x 12,5"/1"	2	2,4	14	36,7	530
PELDAÑO ANG. 60 x 32/3	23,6" x 12,5"/1"	2	1,2	28	18,9	542
ANG. PELDAÑO ANG. 32 x 45/3	12,5" x 17,7"/1"	2	0,32	90	3,2	300
ANG. PELDAÑO 120 EXT/INT 120 x 32 x 45/3	48" x 12,5" x 17,7"/1"	2	2,4	14	32	450
ZANQUÍN 9,8 x 30	3,9" x 11,8"	30	9	48	16,24	794
REMATE PELDAÑO 3 x 32	1" x 12,5"	20	6,4	60	3,5	219
BORDE PISCINA 30 x 36/4	11,8" x 14"/1,5"	3	0,90	44	15,7	691
BORDE PISCINA ESQ. INT. 51,2 x 51,2/4	20,1" x 20,1"/1,5"	1	0,51	18	12,71	245
BORDE PISCINA ESQ. EXT. 51,2 x 51,2/4	20,1" x 20,1"/1,5"	1	0,51	18	12,71	245
REJILLA 12,5 x 30/2,2	4,9" x 11,8"/1"	6	3,6	66	16,55	1.092
REJILLA 12,5 x 60/2,2	4,9" x 23,6"/1"	10	3	36	20,4	735
ESQUINA REJILLA 12,5 x 12,5/2,2	4,9" x 4,9"/1"	24	3	66	18,24	1218
CANALETA 13 x 7,5 x 50	5" x 3" x 19,5"	24	12	20	13,5	300
CANALETA 20 x 14,5 x 50	8" x 5,7" x 19,5"	12	6	20	10,5	225

TECH·RAIL



TECH RAIL ASPEN



TECH RAIL WILLOW

COLORES · COLORS



TECH RAIL ASPEN
21 x 60 (G 58) 8" x 23,6" m²



TECH RAIL NUT
21 x 60 (G 58) 8" x 23,6" m²



TECH RAIL WILLOW
21 x 60 (G 58) 8" x 23,6" m²



TECH RAIL CHERRY
21 x 60 (G 58) 8" x 23,6" m²



TECH RAIL TEAK
21 x 60 (G 58) 8" x 23,6" m²

APLICACIONES · APPLICATIONS



PIEZAS ESPECIALES · SPECIAL PIECES

Disponible en todos los colores · Available in all colors

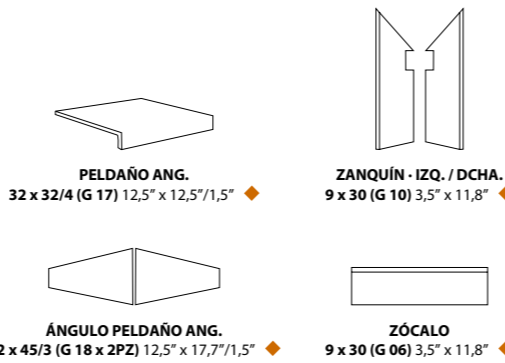

ÁNGULO PELDAÑO ANG. 32 x 45/3 (G 18 x 2PZ) 12,5" x 17,7"/1,5" ◆
ZÓCALO 9 x 30 (G 06) 3,5" x 11,8" ◆



TECH RAIL NUT



TECH RAIL CHERRY

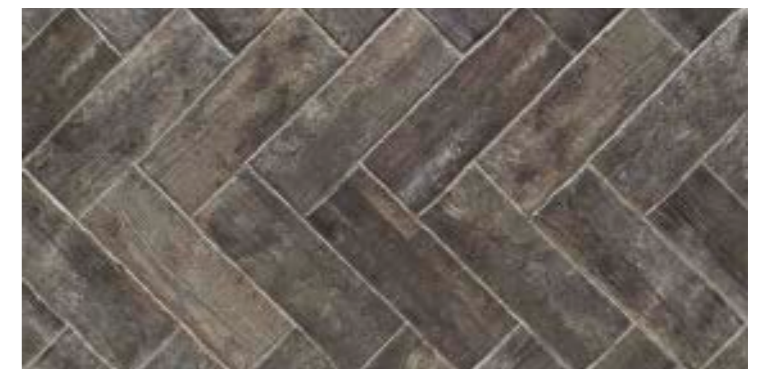

TECH RAIL TEAK

PACKING BASES

FORMATO	PULGADAS	PZ/CAJA	M²	CAJA/PLT	PESO/CAJA	PESO/PLT
21 x 60	8" x 23,6"	6	0,75	72	22,55	1,638

PACKING PIEZAS ESPECIALES

FORMATO	PULGADAS	PZ/CAJA	ML	CAJA/PLT	PESO/CAJA	PESO/PLT
PELDAÑO ANG. 32 x 32/4	12,5" x 12,5"/1,5"	4	1,28	54	11,55	640
ANG. PELDAÑO ANG. 32 x 45/3	12,5" x 17,7"/1,5"	2	0,32	90	3,26	308
ZÓCALO 9 x 30	3,5" x 11,8"	30	9	56	19,60	1.112
ZANQUÍN 9 x 30	3,5" x 11,8"	30	9	56	16,24	924

RETRO



fine **RESISTANCE**
R11 - Class III



RESISTE LA FLEXIÓN
29,1 N/mm2



RESISTE EL DESGASTE
PEI (II - IV)



RESISTE EL RAYADO
MOHS - 8



ANTIDESLIZANTE
Class III - R11



MANCHAS
Class 5 - Class A



ABSORCIÓN
0,3%



DILATACIÓN
6,4* 10⁻⁴ / °C

FORMATO

21 x 60 - 8" x 23,6"
7 x 60 - 3" x 23,6"
36 x 41,5 - 14" x 16,2"
18,5 x 42 - 7" x 16,4"

PE GRES EXTRUSIONADO PORCELÁNICO / PORCELAIN EXTRUDED TILE
PAVIMENTO DE EXTERIOR / OUTDOOR FLOOR TILE
SUPERFICIE MATE / SURFACE MATT
RESISTENCIA A ÁCIDOS Y BASES / RESISTANCE TO ACIDS AND BASES
RESISTENCIA A LA HELADA / FROST PROOF
DESTONIFICADO ARMONIOSO / CONTROLLED DESTONIFICATION
SIN MANTENIMIENTO / NO MAINTENANCE



RETRO BLANC



RETRO TERRA

COLORES · COLORS

fine **RESISTANCE** ▶ R11 - Class III



RETRO BLANC NAVETA
18,5 x 42 (G 39) 7" x 16,4" m²



RETRO TERRA NAVETA
18,5 x 42 (G 39) 7" x 16,4" m²

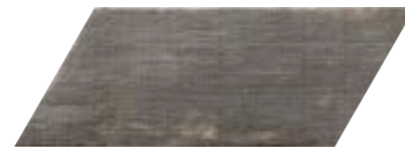

RETRO CENDRA NAVETA
18,5 x 42 (G 39) 7" x 16,4" m²



RETRO NEGRE NAVETA
18,5 x 42 (G 39) 7" x 16,4" m²



RETRO BLANC HEX.
36 x 41,5 (G 58) 14" x 16,2" m²



RETRO TERRA HEX.
36 x 41,5 (G 58) 14" x 16,2" m²

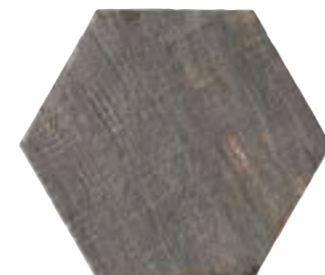

RETRO CENDRA HEX.
36 x 41,5 (G 58) 14" x 16,2" m²

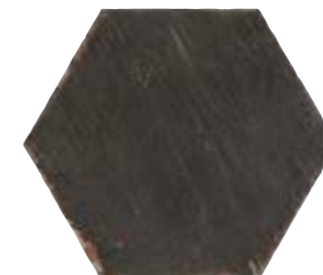

RETRO NEGRE HEX.
36 x 41,5 (G 58) 14" x 16,2" m²



RETRO BLANC
21 x 60 (G 38) 8" x 23,6" m²
7 x 60 (G 27) 3" x 23,6" m²



RETRO TERRA
21 x 60 (G 38) 8" x 23,6" m²
7 x 60 (G 27) 3" x 23,6" m²



RETRO CENDRA
21 x 60 (G 38) 8" x 23,6" m²
7 x 60 (G 27) 3" x 23,6" m²



RETRO NEGRE
21 x 60 (G 38) 8" x 23,6" m²
7 x 60 (G 27) 3" x 23,6" m²



RETRO CENDRA

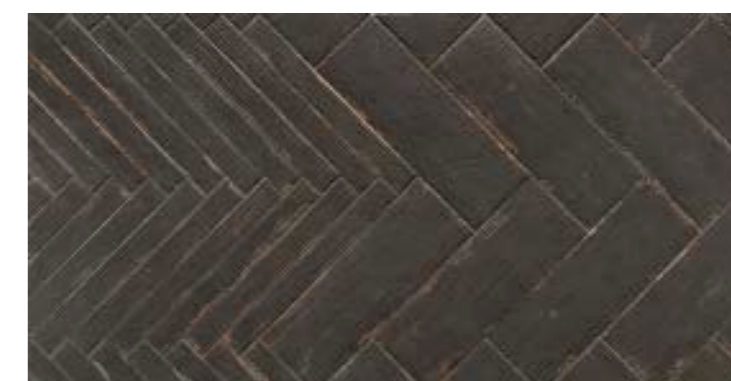

RETRO NEGRE

PACKING BASES

FORMATO	PULGADAS	PZ/CAJA	M ²	CAJA/PLT	PESO/CAJA	PESO/PLT
21 x 60	8" x 23,6"	8	1	72	23,17	1,682
7 x 60	3" x 23,6"	24	1	66	22,25	1,483
HEX. 36 x 41,5	14" x 16,2"	9	1	48	22,6	1,103
NAVETA 18,2 x 42	7" x 16,4"	13	1,01	64	19,93	1,289

PACKING PIEZAS ESPECIALES

FORMATO	PULGADAS	PZ/CAJA	ML	CAJA/PLT	PESO/CAJA	PESO/PLT
PELDAÑO ANG. 32 x 32/4	12,5" x 12,5" / 1,5"	4	1,28	54	11,55	640
ANG. PELDAÑO ANG. 32 x 45/3	12,5" x 17,7" / 1,5"	2	0,32	90	3,16	308
ZÓCALO 9 x 30	3,5" x 11,8"	30	9	56	19,60	1,112
ZANQUÍN 9 x 30	3,5" x 11,8"	30	9	56	16,24	924

PIEZAS ESPECIALES · SPECIAL PIECES

Disponibile in todos los colores · Available in all colors

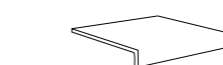

PELDAÑO ANG.
32 x 32/4 (G 17) 12,5" x 12,5" / 1,5" ◆



ÁNGULO PELDAÑO ANG.
32 x 45/3 (G 18 x 2PZ) 12,5" x 17,7" / 1,5" ◆

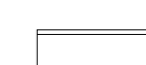

ZÓCALO
9 x 30 (G 06) 3,5" x 11,8" ◆

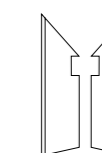

ZANQUÍN - IZQ. / DCHA.
9 x 30 (G 10) 3,5" x 11,8" ◆



fine RESISTANCE
R11 - Class III



RESISTE LA FLEXIÓN
33 N/mm2



RESISTE EL DESGASTE
PEI (III - IV)



RESISTE EL RAYADO
MOHS - 9



ANTIDESLIZANTE
Class III - R12



ANTID.TORUS
0,75 - 0,62



MANCHAS
Class 5 - Class A



ABSORCIÓN
0,1%



DILATACIÓN
6,6° 10° / °C

FORMATO

21 x 60 - 8" x 23,6"
10,5 x 60 - 4" x 23,6"

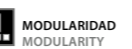
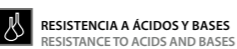

COLORES - COLORS



RIOJA HARO
21 x 60 (G 56) 8" x 23,6"
10,5 x 60 (G 27) 4" x 23,6"



RIOJA LAGUARDIA
21 x 60 (G 56) 8" x 23,6"
10,5 x 60 (G 27) 4" x 23,6"



RIOJA LOGROÑO
21 x 60 (G 56) 8" x 23,6"
10,5 x 60 (G 27) 4" x 23,6"



RIOJA BRIONES
21 x 60 (G 56) 8" x 23,6"
10,5 x 60 (G 27) 4" x 23,6"



RIOJA NAJERA
21 x 60 (G 56) 8" x 23,6"
10,5 x 60 (G 27) 4" x 23,6"



RIOJA ABALOS
21 x 60 (G 56) 8" x 23,6"
10,5 x 60 (G 27) 4" x 23,6"

DECORACIÓN - DECORATION

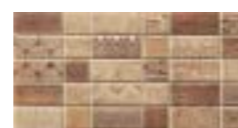

FRONTAL WOOD
15,5 x 30 (G 12) 6" x 11,8"

PIEZAS ESPECIALES - SPECIAL PIECES

Disponible en todos los colores - Available in all colors

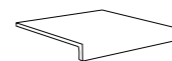

PELDAÑO ANG.
32 x 32/4 (G 17) 12,5" x 12,5"/1,5"

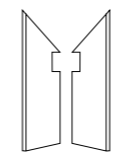

ZANQUÍN - IZQ. / DCHA.
9 x 30 (G 10) 3,5" x 11,8"

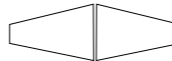

ZÓCALO
9 x 30 (G 06) 3,5" x 11,8"

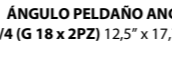

ÁNGULO PELDAÑO ANG.
32 x 45/4 (G 18 x 2PZ) 12,5" x 17,7"/1,5"

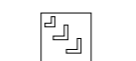

ESQUINA REJILLA
12,5 x 12,5/2,2 (G 19) 4,9" x 4,9"/1"

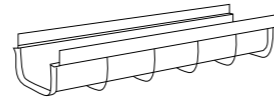

CANALETA (blanco)
13 x 7,5 x 50 (G 30) 5" x 3" x 19,5"
20 x 14,5 x 50 (G 19) 8" x 5,7" x 19,5"



REJILLA
12,5 x 30/2,2 (G 57) 4,9" x 11,8"/1"
12,5 x 60/2,2 (G 59) 4,9" x 23,6"/1"

Disponible en HARO, LAGUARDIA y ABALOS
Available in HARO, LAGUARDIA & ABALOS

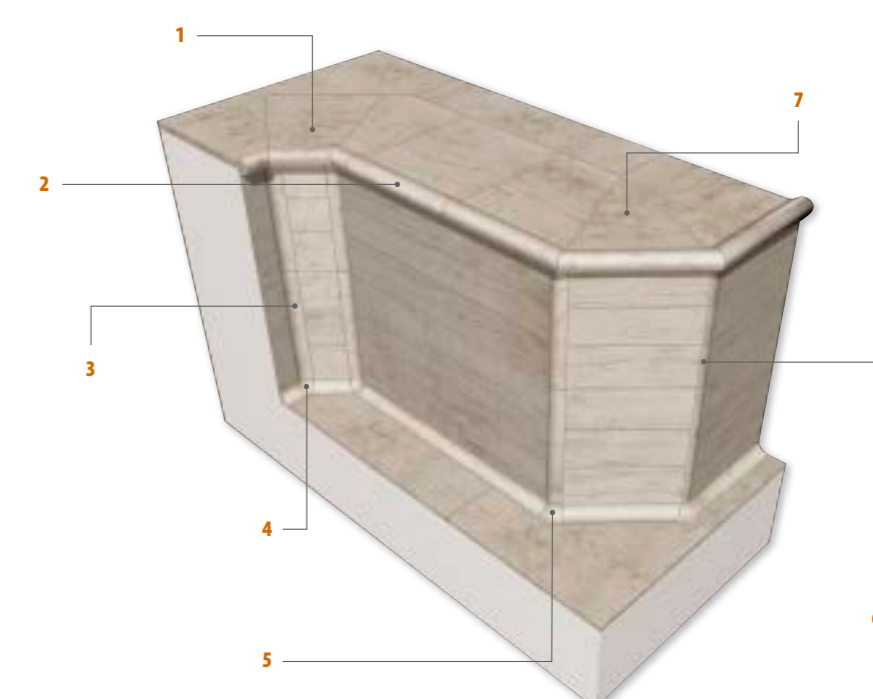
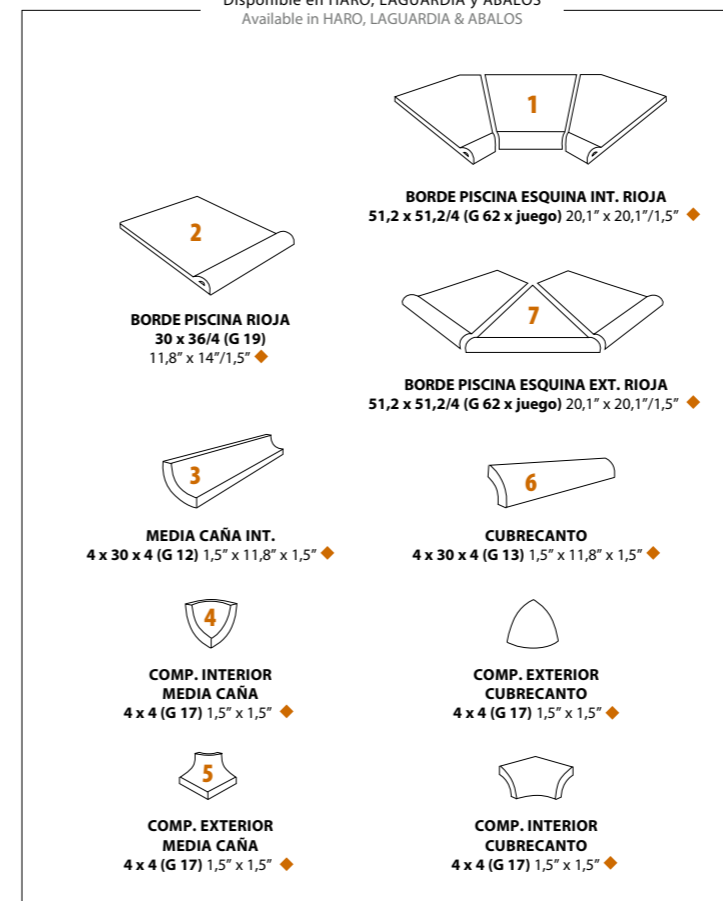

PACKING BASES

FORMATO	PULGADAS	PZ/CAJA	M ²	CAJA/PLT	PESO/CAJA	PESO/PLT
21 x 60	8" x 23,6"	8	1	72	23,17	1.682
10,5 x 60	4" x 23,6"	16	1	72	20,58	1.496

PACKING DECORADO

FORMATO	PULGADAS	PZ/CAJA	ML	CAJA/PLT	PESO/CAJA	PESO/PLT
15,5 x 30	6" x 11,8"	15	4,5	56	14,9	850

PACKING PIEZAS ESPECIALES

FORMATO	PULGADAS	PZ/CAJA	ML	CAJA/PLT	PESO/CAJA	PESO/PLT
PELDAÑO ANG. 32 x 32/4	12,5" x 12,5"/1,5"	4	1,28	54	11,55	640
ZÓCALO 9 x 30	3,5" x 11,8"	30	9	56	19,6	1.112
ZANQUÍN 9 x 30	3,5" x 11,8"	30	9	56	16,24	924
ANG. PELD. ANG. 32 x 45/4	12,5" x 17,7"/1,5"	2	0,32	90	3,20	308
REJILLA 12,5 x 30/2,2	4,9" x 11,8"/1"	6	3,6	66	16,55	1.092
REJILLA 12,5 x 60/2,2	4,9" x 23,6"/1"	10	3	36	20,4	735
ESQUINA REJILLA 12,5 x 12,5/2,2	4,9" x 4,9"/1"	24	3	66	18,24	1218
CANALETA 13 x 7,5 x 50	5" x 3" x 19,5"	24	12	20	13,5	300
CANALETA 20 x 14,5 x 50	8" x 5,7" x 19,5"	12	6	20	10,5	225

PACKING PIEZAS ESPECIALES

FORMATO	PULGADAS	PZ/CAJA	ML	CAJA/PLT	PESO/CAJA	PESO/PLT
BORDE PISCINA 30 x 36/4	11,8" x 14"/1,5"	3	0,9	44	15,7	691
B. PISC. ESQ. EXT. 51,2 x 51,2/4	20,1" x 20,1"/1,5"	1	0,51	18	12,71	245
B. PISC. ESQ. INT. 51,2 x 51,2/4	20,1" x 20,1"/1,5"	1	0,51	18	12,71	245
MEDIA CAÑA INT. 4 x 30 x 4	1,5" x 11,8" x 1,5"	22	6,6	-	9,91	-
COMP. EXT. MEDIA CAÑA 4 x 4	1,5" x 1,5"	20	0,6	-	1,34	-

PACKING PIEZAS ESPECIALES

FORMATO	PULGADAS	PZ/CAJA	ML	CAJA/PLT	PESO/CAJA	PESO/PLT
COMP. INT. MEDIA CAÑA 4 x 4	1,5" x 1,5"	20	0,66	-	1,84	-
CUBRECANTO 4 x 30 x 4	1,5" x 11,8" x 1,5"	26	7,8	-	7,33	-
COMP. EXT. CUBRECANTO 4 x 4	1,5" x 1,5"	25	0,83	-	0,55	-
COMP. INT. CUBRECANTO 4 x 4	1,5" x 1,5"	10	0,33	-	0,85	-

PE GRES EXTRUSIONADO PORCELÁNICO PORCELAIN EXTRUDED TILE **RECT** RECTIFICADO RECTIFIED **DESTONIF. ARMONIOSO** CONTROLLED DESTONIF. **PAV. DE INTERIOR** INDOOR FLOOR TILE **RESIST. A LA HELADA** FROST PROOF **RESIST. A ÁCIDOS Y BASES** RESIST. TO ACIDS & BASES **SUPERFICIE MATE** MATT SURFACE **SIN MANTENIMIENTO** NO MAINTENANCE

PE GRES EXTRUSIONADO PORCELÁNICO PORCELAIN EXTRUDED TILE **RECT** RECTIFICADO RECTIFIED **DESTONIF. ARMONIOSO** CONTROLLED DESTONIF. **PAVIMENTO DE EXTERIOR** OUTDOOR FLOOR TILE **RESIST. A LA HELADA** FROST PROOF **RESIST. A ÁCIDOS Y BASES** RESIST. TO ACIDS & BASES **SUPERFICIE MATE** MATT SURFACE **SIN MANTENIMIENTO** NO MAINTENANCE



COLORES · COLORS

COLORES · COLORS

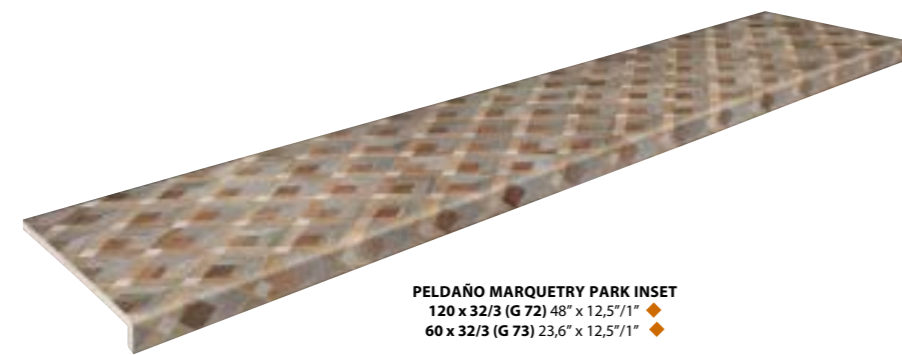

PELDAÑO MARQUETRY PARK INSET
120 x 32/3 (G 72) 48" x 12,5"/1" ♦
60 x 32/3 (G 73) 23,6" x 12,5"/1" ♦



PELDAÑO MARQUETRY PARK SPIKE
120 x 32/3 (G 72) 48" x 12,5"/1" ♦
60 x 32/3 (G 73) 23,6" x 12,5"/1" ♦



PELDAÑO ANGULAR STONE CEMENT
120 x 32/3 (G 72) 48" x 12,5"/1" ♦
60 x 32/3 (G 73) 23,6" x 12,5"/1" ♦



PELDAÑO ANGULAR STONE TEXTILE
120 x 32/3 (G 72) 48" x 12,5"/1" ♦
60 x 32/3 (G 73) 23,6" x 12,5"/1" ♦

PACKING PIEZAS ESPECIALES

FORMATO	PULGADAS	PZ/CAJA	ML	CAJA/PLT	PESO/CAJA	PESO/PLT
PELDAÑO ANG. 120 x 32/3	48" x 12,5" x 1"	2	2,4	14	19,20	284
PELDAÑO ANG. 60 x 32/3	23,6" x 12,5" x 1"	2	1,2	28	9,60	284

PACKING PIEZAS ESPECIALES

FORMATO	PULGADAS	PZ/CAJA	ML	CAJA/PLT	PESO/CAJA	PESO/PLT
PELDAÑO ANG. 120 x 32/3	48" x 12,5" x 1"	2	2,4	14	19,20	284
PELDAÑO ANG. 60 x 32/3	23,6" x 12,5" x 1"	2	1,2	28	9,60	284

MEMORY

PORCELÁNICO
PORCELAIN TILE

Comfort floor

CLASE I - R9
UNE 41901:2017 EX
DIN 51130:2014

FORMATO

60 x 120 - 23,6" x 48"
59,5 x 59,5 - 23,2" x 23,2"

ANTI-BACTERIAL

P PORCELÁNICO PORCELAIN TILE
 RECT RECTIFICADO RECTIFIED
 DA DESTONIFICADO ARMONIOSO CONTROLLED DESTONIFICATION
 PAV. DE INTERIOR INDOOR FLOOR TILE
 RESIST. A LA HELADA FROST PROOF
 RESIST. A ÁCIDOS Y BASES RESIST. TO ACIDS & BASES
 SUPERFICIE MATE MATT SURFACE
 SIN MANTENIMIENTO NO MAINTENANCE



COLORES · COLORS

PIEZAS ESPECIALES · SPECIAL PIECES

Disponible en todos los colores
Available in all colors



MEMORY SANDY
60 x 120 (G 69) 23,6" x 48" m



MEMORY BRASS
60 x 120 (G 69) 23,6" x 48" m



MEMORY OXIDE
60 x 120 (G 69) 23,6" x 48" m



MEMORY OPAL
60 x 120 (G 69) 23,6" x 48" m



MEMORY NAVY
60 x 120 (G 69) 23,6" x 48" m

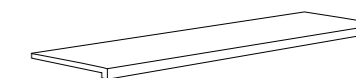

PELDAÑO ANGULAR
120 x 32/3 (G 72) 48" x 12,5"/1"
60 x 32/3 (G 73) 23,6" x 12,5"/1"

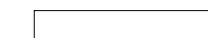

FRONTAL
15 x 120 (G 74) 6" x 48"

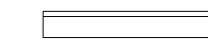

ZÓCALO
9,8 x 120 (G 74) 3,9" x 48"
9,8 x 60 (G 75) 3,9" x 23,6"

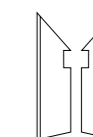

ZANQUÍN · IZQ. / DRCH.
9,8 x 30 (G 12) 3,9" x 11,8"



REMATE PELDAÑO ANGULAR · IZQ. / DRCH.
3 x 32 (G 15) 1" x 12,5"

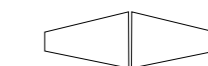

ÁNGULO PELDAÑO ANG.
32 x 45/3 (G 17,7 x 2PZ)
12,5" x 17,7"/1"

PACKING BASES

FORMATO	PULGADAS	PZ/CAJA	M ²	CAJA/PLT	PESO/CAJA	PESO/PLT
60 x 120	23,6" x 48"	2	1,44	32	32,6	1059

PIEZAS ESPECIALES

FORMATO	PULGADAS	PZ/CAJA	M ²	CAJA/PLT	PESO/CAJA	PESO/PLT
PELDAÑO ANG. 120 x 32/3	48" x 12,5" x 1"	2	2,4	14	36,7	530
PELDAÑO ANG. 60 x 32/3	23,6" x 12,5" x 1"	2	1,2	28	18,9	542
FRONTAL 15 x 120	6" x 48"	4	4,8	48	16,9	826
ZANQUÍN 9,8 x 30	3,9" x 11,8"	30	9	48	16,24	794
ANG. PELD. ANG. 32 x 45/3	12,5" x 17,7"/1"	2	0,32	90	3,20	300

PACKING PIEZAS ESPECIALES

FORMATO	PULGADAS	PZ/CAJA	ML	CAJA/PLT	PESO/CAJA	PESO/PLT
REMATE PELDAÑO 3 x 32	1" x 12,5"	20	6,4	60	3,5	219
ZÓCALO 9,8 x 120	3,9" x 48"	8	9,6	63	22	1400
ZÓCALO 9,8 x 60	3,9" x 23,6"	16	9,6	72	21,9	1591

MEMORY

PORCELÁNICO
PORCELAIN TILE

Comfort floor

CLASE I - R9
UNE 41901:2017 EX
DIN 51130:2014

FORMATO

60 x 120 - 23,6" x 48"
59,5 x 59,5 - 23,2" x 23,2"

ANTI-BACTERIAL

P PORCELÁNICO PORCELAIN TILE **RECT** RECTIFICADO RECTIFIED **DESTONIFICADO ARMONIOSO** CONTROLLED DESTONIFICATION **PAV. DE INTERIOR** INDOOR FLOOR TILE **RESIST. A LA HELADA** FROST PROOF **RESIST. A ÁCIDOS Y BASES** RESIST. TO ACIDS & BASES **SUPERFICIE MATE** MATT SURFACE **SIN MANTENIMIENTO** NO MAINTENANCE



COLORES · COLORS



MEMORY SANDY
59,5 x 59,5 (G 69) 23,2" x 23,2" m²



MEMORY BRASS
59,5 x 59,5 (G 69) 23,2" x 23,2" m²



MEMORY OXIDE
59,5 x 59,5 (G 69) 23,2" x 23,2" m²

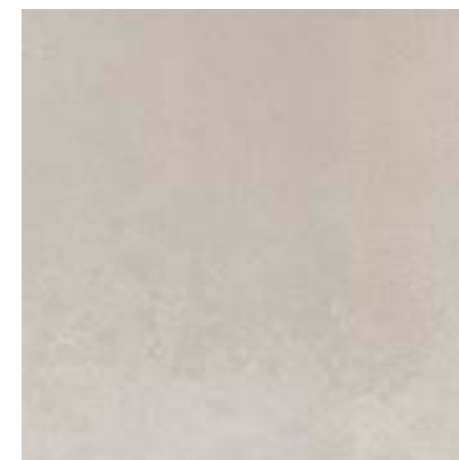

MEMORY OPAL
59,5 x 59,5 (G 69) 23,2" x 23,2" m²



MEMORY NAVY
59,5 x 59,5 (G 69) 23,2" x 23,2" m²

PIEZAS ESPECIALES · SPECIAL PIECES

Disponible en todos los colores
Available in all colors

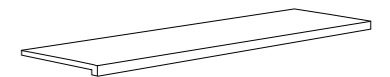

PELDAÑO ANGULAR
120 x 32/3 (G 72) 48" x 12,5"/1"
60 x 32/3 (G 73) 23,6" x 12,5"/1"

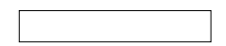

FRONTAL
15 x 120 (G 74) 6" x 48"

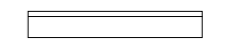

ZÓCALO
9,8 x 120 (G 74) 3,9" x 48"
9,8 x 60 (G 75) 3,9" x 23,6"

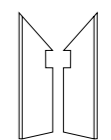

ZANQUÍN · IZQ. / DRCH.
9,8 x 30 (G 12) 3,9" x 11,8"

REMATE PELDAÑO ANGULAR · IZQ. / DRCH.
3 x 32 (G 15) 1" x 12,5"

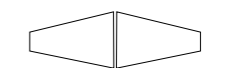

ÁNGULO PELDAÑO ANG.
32 x 45/3 (G 18 x 2PZ)
12,5" x 17,7"/1"

PACKING BASES

FORMATO	PULGADAS	PZ/CAJA	M ²	CAJA/PLT	PESO/CAJA	PESO/PLT
59,5 x 59,5	23,2" x 23,2"	4	1,42	30	32,60	993

PIEZAS ESPECIALES

FORMATO	PULGADAS	PZ/CAJA	M ²	CAJA/PLT	PESO/CAJA	PESO/PLT
PELDAÑO ANG. 120 x 32/3	48" x 12,5" x 1"	2	2,4	14	19,20	284
PELDAÑO ANG. 60 x 32/3	23,6" x 12,5" x 1"	2	1,2	28	9,60	284
FRONTAL 15 x 120	6" x 48"	4	4,8	48	16,9	826
ZANQUÍN 9,8 x 30	3,9" x 11,8"	30	9	48	16,24	794
ANG. PELD. ANG. 32 x 45/3	12,5" x 17,7"/1"	2	0,32	90	3,20	300

PACKING PIEZAS ESPECIALES

FORMATO	PULGADAS	PZ/CAJA	ML	CAJA/PLT	PESO/CAJA	PESO/PLT
REMATE PELDAÑO 3 x 32	1" x 12,5"	20	6,4	60	3,5	219
ZÓCALO 9,8 x 120	3,9" x 48"	8	9,6	63	22	1400
ZÓCALO 9,8 x 60	3,9" x 23,6"	16	9,6	72	21,9	1591

MEMORY

EVOLUTION
EXTRUDED PORCELAIN TILE

fine RESISTANCE

ANTI-BACTERIAL

CLASE III - R 11
UNE-41901:2017 EXT
DIN 51130:2014

AntiSlip

FORMATO

36 x 36 - 14" x 14"
18 x 36 - 7" x 14"
18 x 18 - 7" x 7"

GRES EXTRUSIONADO PORCELÁNICO / PORCELAIN EXTRUDED TILE
DESTONIFICADO ARMONIOSO / CONTROLLED DESTONIFICATION
PAVIMENTO DE EXTERIOR / OUTDOOR FLOOR TILE
RESIST. A LA HELADA / FROST PROOF
RESIST. A ÁCIDOS Y BASES / RESIST. TO ACIDS & BASES
MODULARIDAD / MODULARITY
SUPERFICIE MATE / MATT SURFACE
SIN MANTENIMIENTO / NO MAINTENANCE



COLORES · COLORS



MEMORY SANDY ANTISLIP
18 x 18 (G 57) 7" x 7" m²



MEMORY BRASS ANTISLIP
18 x 18 (G 57) 7" x 7" m²



MEMORY OXIDE ANTISLIP
18 x 18 (G 57) 7" x 7" m²



MEMORY OPAL ANTISLIP
18 x 18 (G 57) 7" x 7" m²



MEMORY NAVY ANTISLIP
18 x 18 (G 57) 7" x 7" m²

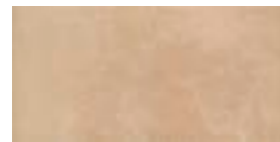

MEMORY SANDY ANTISLIP
18 x 36 (G 57) 7" x 14" m²



MEMORY BRASS ANTISLIP
18 x 36 (G 57) 7" x 14" m²



MEMORY OXIDE ANTISLIP
18 x 36 (G 57) 7" x 14" m²

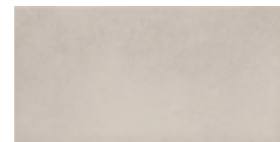

MEMORY OPAL ANTISLIP
18 x 36 (G 57) 7" x 14" m²



MEMORY NAVY ANTISLIP
18 x 36 (G 57) 7" x 14" m²



MEMORY SANDY ANTISLIP
36 x 36 (G 57) 14" x 14" m²

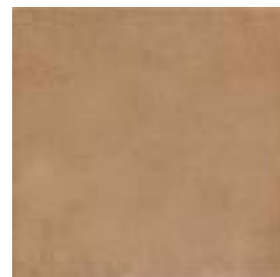

MEMORY BRASS ANTISLIP
36 x 36 (G 57) 14" x 14" m²



MEMORY OXIDE ANTISLIP
36 x 36 (G 57) 14" x 14" m²



MEMORY OPAL ANTISLIP
36 x 36 (G 57) 14" x 14" m²

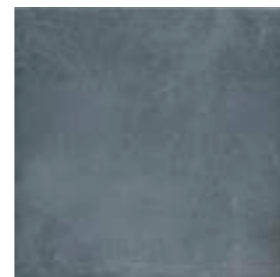

MEMORY NAVY ANTISLIP
36 x 36 (G 57) 14" x 14" m²

PACKING BASES

FORMATO	PULGADAS	PZ/CAJA	M ²	CAJA/PLT	PESO/CAJA	PESO/PLT
36 x 36	14" x 14"	8	1	48	22,04	1.072
18 x 36	7" x 14"	16	1	72	23,33	1.694
18 x 18	7" x 7"	30	0,97	72	21,4	1.555
MODULO C	-	18	1,04	48	23	1.120
MODULO D	-	12	0,91	64	20	1.300

PACKING PIEZAS ESPECIALES

FORMATO	PULGADAS	PZ/CAJA	ML	CAJA/PLT	PESO/CAJA	PESO/PLT
DESBORDANTE 36 x 33/2,2	14" x 13"/1"	7	2,52	44	27,4	1.221
ESQ. EXT. DESB. 33 x 33 x 46/2,2	13" x 13 x 18"/1"	2	0,33	90	3,8	357
ESQ. INT. DESB. 33 x 33 x 46/2,2	13" x 13 x 18"/1"	2	0,33	90	3,8	357
GRATTING 19 x 36/2,2	7" x 14"/1"	8	2,16	56	19,54	1.109
ESQ. GRATTING 19 x 36 x 26,8/2,2	7" x 14" x 10,5"/1"	8	2,16	56	14,30	815

MODULACIÓN · MODULATION

Disponible en todos los colores · Available in all colors

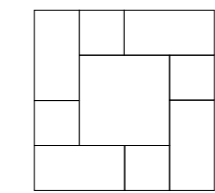

MEMORY MODULO C (G 56)
packing: 1,04 m²/caja m²



MEMORY MODULO D (G 56)
packing: 0,91 m²/caja m²

PIEZAS ESPECIALES · SPECIAL PIECES

Disponible en OPAL, SANDY, BRASS Y OXIDE
Available in OPAL, SANDY, BRASS & OXIDE

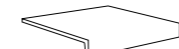

PELDAÑO ANG. ANTISLIP
36 x 32/3 (G 18) 14" x 12,5"/1"

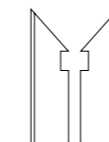

ZANQUÍN - IZQ. / DCHA.
9 x 36 (G 10) 3,5" x 14"

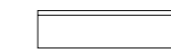

ZÓCALO ANTISLIP
9 x 36 (G 07) 3,5" x 14"



ÁNGULO PELDAÑO ANG. ANTISLIP
32 x 45/3 (G 19 x 2PZ) 12,5" x 17,7"/1"

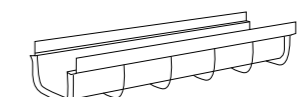

CANALETA (blanco)
13 x 7,5 x 50 (G 30) 5" x 3" x 19,5"
20 x 14,5 x 50 (G 19) 8" x 5,7" x 19,5"



ESQUINA REJILLA
12,5 x 12,5/2,2 (G 19) 4,9" x 4,9"/1"

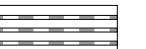

REJILLA
12,5 x 30/2,2 (G 57) 4,9" x 11,8"/1"
12,5 x 60/2,2 (G 59) 4,9" x 23,6"/1"

Disponible en OPAL Y SANDY
Available in OPAL & SANDY

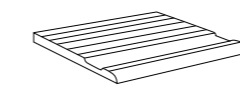

DESBORDANTE
36 x 33/2,2 (G 19) 14" x 13"/1"

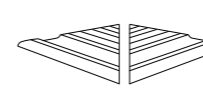

ESQ. EXT. DESBORDANTE
33 x 33 x 46/2,2 (G 20 x 2)
13" x 13" x 18"/1"

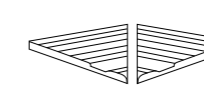

ESQ. INT. DESBORDANTE
33 x 33 x 46/2,2 (G 20 x 2)
13" x 13" x 18"/1"

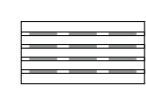

GRATTING
19 x 36/2,2 (G 36)
7" x 14"/1"

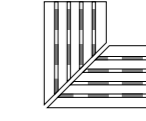

ESQUINA GRATTING
19 x 36 x 26,8/2,2 (G 23 x 2)
7" x 14" x 10,5"/1"

Disponible en NAVY
Available in NAVY

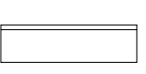

ZÓCALO ANTISLIP
9 x 36 (G 07) 3,5" x 14"

PACKING PIEZAS ESPECIALES

FORMATO	PULGADAS	PZ/CAJA	ML	CAJA/PLT	PESO/CAJA	PESO/PLT
PELD. ANG. 36 x 32/3	14" x 12,5"/1"	4	1,44	54	13,36	736
ANG. PELD. 32 x 45/3	12,5" x 17,7"/1"	2	0,33	90	3,46	325
ZÓCALO 9 x 36	3,5" x 14"	30	10,8	56	23,8	1.275
ZANQUÍN 9 x 36	3,5" x 14"	30	10,8	56	19,6	1.135

PACKING PIEZAS ESPECIALES

FORMATO	PULGADAS	PZ/CAJA	ML	CAJA/PLT	PESO/CAJA	PESO/PLT
REJILLA 12,5 x 30/2,2	4,9" x 11,8"/1"	6	3,6	66	16,55	1.092
REJILLA 12,5 x 60/2,2	4,9" x 23,6"/1"	10	3	36	20,4	735
ESQUINA REJILLA 12,5 x 12,5/2,2	4,9" x 4,9"/1"	24	3	66	18,24	1.218
CANALETA 13 x 7,5 x 50	5" x 3" x 19,5"	24	12	20	13,5	300
CANALETA 20 x 14,5 x 50	8" x 5,7" x 19,5"	12	6	20	10,5	225

Tucson

PORCELÁNICO
PORCELAIN TILE

ANTI-BACTERIAL

RESISTE LA FLEXIÓN	RESISTE EL DESGASTE	RESISTE EL RAYADO	ANTIDESLIZANTE	MANCHAS	ABSORCIÓN	CARGA DE ROTURA	
51 N/mm2	PEI III-IV	MOHS - 5	Class I - R9	Class 5 - Class A	0,1%	3059 Nw	INTERIOR
51 N/mm2	PEI IV-V	MOHS - 6	Class III - R11	Class 5 - Class A	0,1%	3059 Nw	EXTERIOR

Comfort floor
CLASE I - R 9
UNE 41901:2017 EX
DIN 51130:2004

fine RESISTANCE
CLASE III - R 11
UNE 41901:2017 EX
DIN 51130:2004

FORMATO
80 x 80 - 31,5" x 31,5"

PORCELÁNICO PORCELAIN TILE	RECTIFICADO RECTIFIED	DESTONIFICADO ARMONIOSO CONTROLLED DESTONIFICATION	DISEÑOS DIFERENTES DIFFERENT DESIGNS	RESIST. A LA HELADA FROST PROOF	RESIST. A ÁCIDOS Y BASES RESIST. TO ACIDS & BASES	SUPERFICIE MATE MATT SURFACE	SIN MANTENIMIENTO NO MAINTENANCE
-------------------------------	--------------------------	---	---	------------------------------------	--	---------------------------------	-------------------------------------



COLORES · COLORS



TUCSON WHITE
80 x 80 (G 69) 31,5" x 31,5"

TUCSON WHITE ANTISLIP
80 x 80 (G 71) 31,5" x 31,5"



TUCSON NATURAL
80 x 80 (G 69) 31,5" x 31,5"



TUCSON GREY
80 x 80 (G 69) 31,5" x 31,5"

TUCSON GREY ANTISLIP
80 x 80 (G 71) 31,5" x 31,5"



TUCSON IRON
80 x 80 (G 69) 31,5" x 31,5"

PACKING BASES

FORMATO	PULGADAS	PZ/CAJA	M²	CAJA/PLT	PESO/CAJA	PESO/PLT
80 x 80	31,5" x 31,5"	2	1,28	40	29	1.180

PACKING PIEZAS ESPECIALES

FORMATO	PULGADAS	PZ/CAJA	ML	CAJA/PLT	PESO/CAJA	PESO/PLT
PELDAÑO ANG. 120 x 32/3	48" x 12,5"/1"	2	2,4	14	19,20	284
ANG. PELDAÑO 120 INT. 120 x 32 x 45/3	48" x 12,5" x 17,7"/1"	2	2,4	14	18	253
ANG. PELDAÑO 120 EXT. 120 x 32 x 45/3	48" x 12,5" x 17,7"/1"	2	2,4	14	18	253
PELDAÑO ANG. 60 x 32/3	23,6" x 12,5"/1"	2	1,2	28	9,60	284
ANG. PELDAÑO ANG. 32 x 45/3	12,5" x 17,7"/1"	2	0,32	90	3,46	325
REMATE PELDAÑO 3 x 32	1" x 12,5"	20	6,4	60	3,5	219
ZANQUÍN 7,5 x 30	3" x 11,8"	30	9	48	16,24	794
ZÓCALO 7,5 x 80	3" x 31,5"	20	16	60	25	1.515
ZÓCALO 7,5 x 60	3" x 23,6"	24	14,4	66	22,9	1.526

PIEZAS ESPECIALES · SPECIAL PIECES

Disponible en todos los colores
Available in all colors



Disponible en todos los colores
Available in all colors

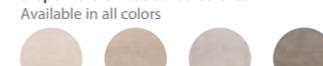

PELDAÑO ANGULAR
120 x 32/3 (G 72) 48" x 12,5" x 1"
60 x 32/3 (G 73) 23,6" x 12,5" x 1"

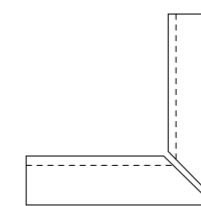

ÁNGULO PELDAÑO 120. INT
120 x 32 x 45/3 (G 46 x 2)
48" x 12,5" x 17,7" / 1"

fine RESISTANCE ▶ R11 - Class III

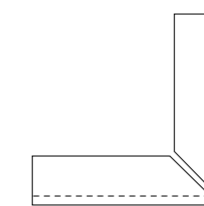

ÁNGULO PELDAÑO 120. EXT
120 x 32 x 45/3 (G 46 x 2)
48" x 12,5" x 17,7" / 1"

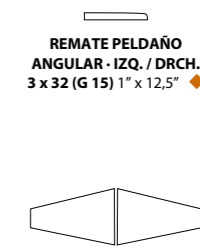

REMATE PELDAÑO ANGULAR · IZQ. / DRCH.
3 x 32 (G 15) 1" x 12,5"

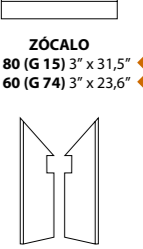

ZÓCALO
7,5 x 80 (G 15) 3" x 31,5"
7,5 x 60 (G 74) 3" x 23,6"

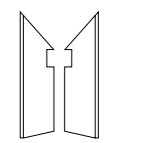

ZANQUÍN · IZQ. / DRCH.
7,5 x 30 (G 12) 3" x 11,8"

Comfort floor ▶ R9 - Class I

TUCSON

OUTDOOR

EVOLUTION
EXTRUDED PORCELAIN TILE

fine RESISTANCE

CLASE III - R 11
UNE 41901:2017 EX
DIN 51130:2014

ANTI-BACTERIAL

FORMATO
30 x 60 - 11,8" x 23,6"

PE GRES EXTRUSIONADO PORCELÁNICO
PORCELAIN EXTRUDED TILE

DESTONIFICADO ARMONIOSO
CONTROLLED DESTONIFICATION

PAVIMENTO DE EXTERIOR
OUTDOOR FLOOR TILE

RESIST. A LA HELADA
FROST PROOF

RESIST. A ÁCIDOS Y BASES
RESIST. TO ACIDS & BASES

SUPERFICIE MATE
MATT SURFACE

SIN MANTENIMIENTO
NO MAINTENANCE

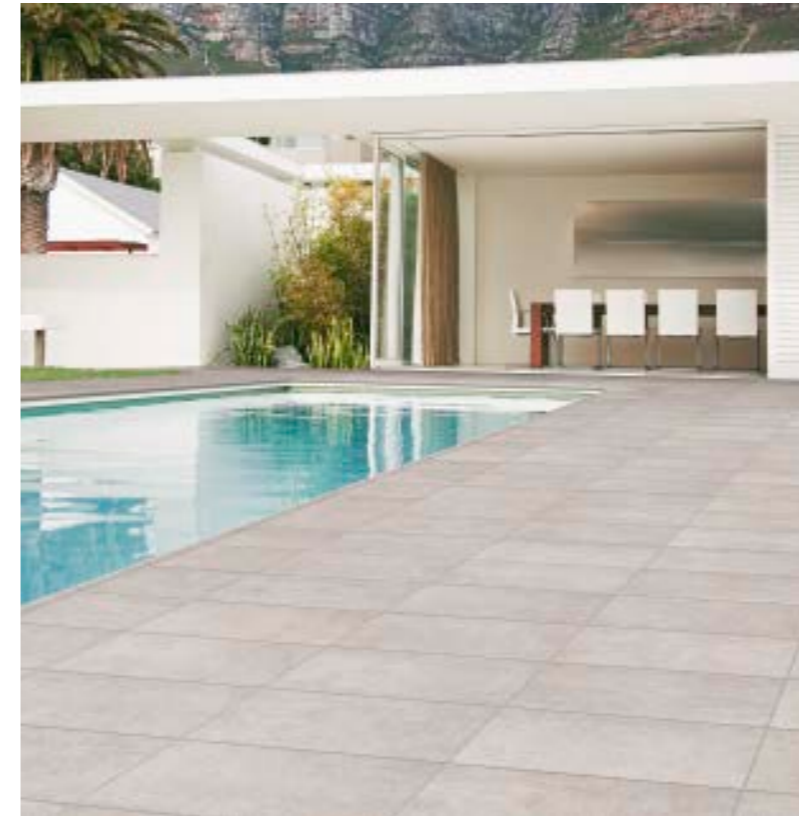

COLORES · COLORS



TUCSON WHITE ANTISLIP
30 x 60 (G 69) 11,8" x 23,6" m²



TUCSON GREY ANTISLIP
30 x 60 (G 69) 11,8" x 23,6" m²



TUCSON NATURAL ANTISLIP
30 x 60 (G 69) 11,8" x 23,6" m²

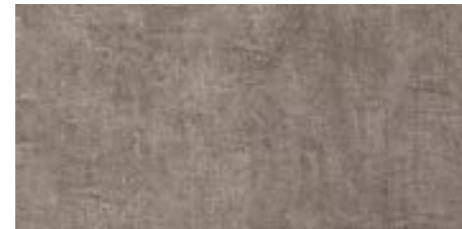

TUCSON IRON ANTISLIP
30 x 60 (G 69) 11,8" x 23,6" m²

PACKING BASES

FORMATO	PULGADAS	PZ/CAJA	M ²	CAJA/PLT	PESO/CAJA	PESO/PLT
30 x 60	11,8" x 23,6"	6	1,08	48	24,82	1,207

PACKING PIEZAS ESPECIALES

FORMATO	PULGADAS	PZ/CAJA	ML	CAJA/PLT	PESO/CAJA	PESO/PLT
DESBORDANTE 30 x 30/2,2	11,8" x 11,8"/1	6	1,8	44	17,75	795
ESQ. EXT. DESB. 30 x 30 x 41,5/2,2	11,8" x 11,8" x 16"/1	2	0,33	90	3,8	357
ESQ. INT. DESB. 30 x 30 x 41,5/2,2	11,8" x 11,8" x 16"/1	2	0,33	90	3,8	357
GRATTING 19 x 30/2,2	7" x 11,8"/1	8	2,4	56	19,54	1109
ESQ. GRATTING 30 x 19 x 25,5/2,2	11,8" x 7" x 10"/1	8	2,16	56	14,30	815

PACKING PIEZAS ESPECIALES

FORMATO	PULGADAS	PZ/CAJA	ML	CAJA/PLT	PESO/CAJA	PESO/PLT
ZÓCALO 7,5 x 60	3" x 23,6"	16	9,6	72	21,9	1591
PELDAÑO ANG. 120 x 32/3	48" x 12,5"/1"	2	2,4	14	19,20	284
PELDAÑO ANG. 60 x 32/3	23,6" x 12,5"/1"	2	1,2	28	9,60	284
ANG. PELDAÑO ANG. 32 x 45/3	12,5" x 17,7"/1"	2	2,4	14	18	253
ANG. PELDAÑO 120 EXT/INT 120 x 32 x 45/3	48" x 12,5" x 17,7"/1"	2	2,4	14	32	450
ZANQUÍN 7,5 x 30	3" x 11,8"	30	9	48	16,24	794
REMATE PELDAÑO 3 x 32	1" x 12,5"	20	6,4	60	3,5	219
BORDE PISCINA 30 x 36/4	11,8" x 14"/1,5"	3	0,90	44	15,7	691
BORDE PISCINA ESQ. INT. 51,2 x 51,2/4	20,1" x 20,1"/1,5"	1	0,51	18	12,71	245
BORDE PISCINA ESQ. EXT. 51,2 x 51,2/4	20,1" x 20,1"/1,5"	1	0,51	18	12,71	245
REJILLA 12,5 x 30/2,2	4,9" x 11,8"/1"	6	3,6	66	16,55	1092
REJILLA 12,5 x 60/2,2	4,9" x 23,6"/1"	10	3	36	20,4	735
ESQUINA REJILLA 12,5 x 12,5/2,2	4,9" x 4,9"/1"	24	3	66	18,24	1218
CANALETA 13 x 7,5 x 50	5" x 3" x 19,5"	24	12	20	13,5	300
CANALETA 20 x 14,5 x 50	8" x 5,7" x 19,5"	12	6	20	10,5	225

PIEZAS ESPECIALES · SPECIAL PIECES

Disponible en WHITE y GREY ANTISLIP
Available in WHITE & GREY ANTISLIP

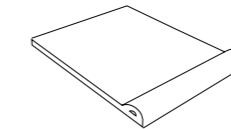

BORDE PISCINA
30 x 36/4 (G 19) 11,8" x 14"/1,5" ◆

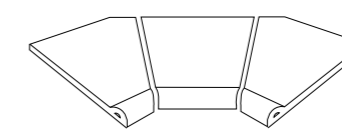

BORDE PISCINA ESQ. INT.
51,2 x 51,2/4 (G 62 x juego)
20,1" x 20,1"/1,5" ◆

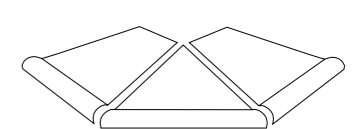

BORDE PISCINA ESQ. EXT.
51,2 x 51,2/4 (G 62 x juego)
20,1" x 20,1"/1,5" ◆

Disponible en NATURA ANTISLIP
Available in NATURA ANTISLIP



DESBORDANTE
30 x 30/2,2 (G 17) 11,8" x 11,8"/1" ◆



ESQ. EXT. DESBORDANTE
30 x 30 x 41,5/2,2 (G 19 x 2)
11,8" x 11,8" x 16"/1" ◆



ESQ. INT. DESBORDANTE
30 x 30 x 41,5/2,2 (G 19 x 2)
11,8" x 11,8" x 16"/1" ◆



GRATTING
19 x 30/2,2 (G 18)
7" x 11,8"/1" ◆

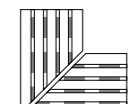

ESQUINA GRATTING
30 x 19 x 25,5/2,2 (G 20 x 2)
11,8" x 7" x 10"/1" ◆

Disponible en todos los colores · Available in all colors

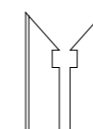

ZANQUÍN · IZQ. / DCHA.
7,5 x 30 (G 12) 3" x 11,8" ◆



ZÓCALO
7,5 x 60 (G 74) 3" x 23,6" ◆

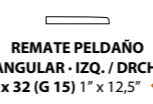

REMATE PELDAÑO
ANGULAR · IZQ. / DRCH.
3 x 32 (G 15) 1" x 12,5" ◆



ÁNGULO PELDAÑO ANG.
32 x 45/3 (G 18 x 2PZ) 12,5" x 17,7"/1" ◆

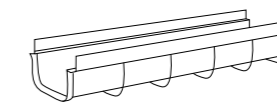

CANALETA (blanco)
13 x 7,5 x 50 (G 30) 5" x 3" x 19,5" ◆
20 x 14,5 x 50 (G 19) 8" x 5,7" x 19,5" ◆



REJILLA
12,5 x 30/2,2 (G 57) 4,9" x 11,8"/1" ◆
12,5 x 60/2,2 (G 59) 4,9" x 23,6"/1" ◆



ESQUINA REJILLA
12,5 x 12,5/2,2 (G 19) 4,9" x 4,9"/1" ◆

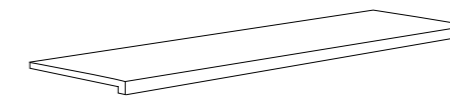

PELDAÑO ANGULAR
120 x 32/3 (G 72) 48" x 12,5"/1" ◆
60 x 32/3 (G 73) 23,6" x 12,5"/1" ◆

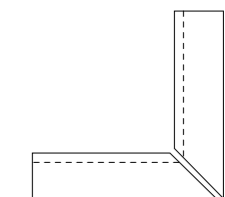

ÁNGULO PELDAÑO 120. INT
120 x 32 x 45/3 (G 46 x 2)
48" x 12,5" x 17,7"/1" ◆

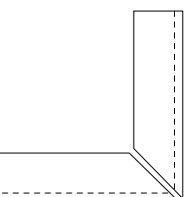

ÁNGULO PELDAÑO 120. EXT
120 x 32 x 45/3 (G 46 x 2)
48" x 12,5" x 17,7"/1" ◆

Everest

inklinker
EVOLUTION
EXTRUDED PORCELAIN TILE

in & out
INTERIOR - EXTERIOR

RESISTE LA FLEXIÓN	RESISTE EL DESGASTE	RESISTE EL RAYADO	ANTIDESLIZANTE	ANTIDOLOR	MANCHAS	ABSORCIÓN	DILATACIÓN	
29 N/mm2	PEI (II - IV)	MOHS - 9	Class III - R11	0,80 - 0,75	Class S - Class A	<0,5%	6,0° 10°/°C	fine RESISTANCE
29 N/mm2	PEI (II - IV)	MOHS - 7	Class II - R9	0,40 - 0,55	Class S - Class A	<0,5%	6,0° 10°/°C	Comfort floor

GRES EXTR. PORCELÁNICO PORCELAIN EXTR. TILE	PAV. DE INTERIOR INDOOR FLOOR TILE	PAV. DE EXTERIOR OUTDOOR FLOOR TILE	SUPERFICIE MATE SURFACE MATT	SIN MANTENIMIENTO NO MAINTENANCE	RES. A ÁCIDOS Y BASES RES. TO ACIDS AND BASES	RES. A LA HELADA FROST PROOF	DESTONIFICADO ARMONIOSO CONTROLLED DESTONIFICATION



COLORES · COLORS

Comfort floor ▶ R 9 - Class II

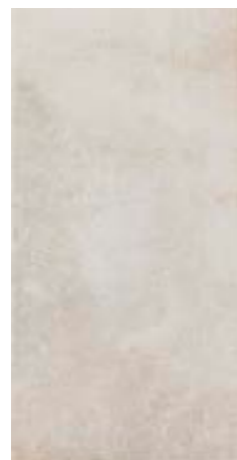

EVEREST SUR
30 x 60 (G 57) 11,8" x 23,6" m²



EVEREST CENTRO
30 x 60 (G 57) 11,8" x 23,6" m²



EVEREST OESTE
30 x 60 (G 57) 11,8" x 23,6" m²



EVEREST ESTE
30 x 60 (G 57) 11,8" x 23,6" m²



EVEREST NORTE
30 x 60 (G 57) 11,8" x 23,6" m²

COLORES · COLORS

fine RESISTANCE ▶ R11 - Class III



EVEREST NIEVE
30 x 60 (G 57) 11,8" x 23,6" m²

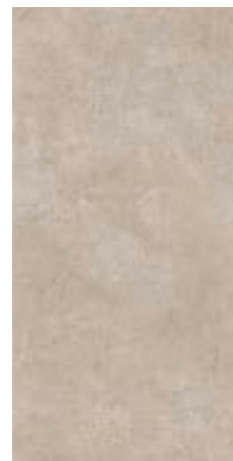

EVEREST LLUVIA
30 x 60 (G 57) 11,8" x 23,6" m²



EVEREST TIERRA
30 x 60 (G 57) 11,8" x 23,6" m²



EVEREST PIEDRA
30 x 60 (G 57) 11,8" x 23,6" m²



EVEREST GRAFITO
30 x 60 (G 57) 11,8" x 23,6" m²

DECORACIÓN · DECORATION

PE



FRONTAL STONE
15,5 x 30 (G 12) 6" x 11,8" ◆

PIEZAS ESPECIALES · SPECIAL PIECES

Disponibles en LLUVIA, NIEVE y PIEDRA CLASE III - R 11
Available in LLUVIA, NIEVE & PIEDRA CLASE III - R 11

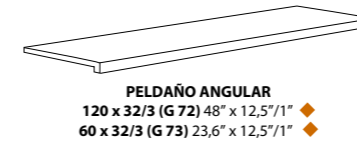

PELDAÑO ANGULAR
120 x 32/3 (G 72) 48" x 12,5"/1" ◆
60 x 32/3 (G 73) 23,6" x 12,5"/1" ◆

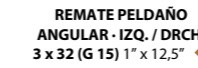

REMATE PELDAÑO
ANGULAR - IZQ. / DRCH.
3 x 32 (G 15) 1" x 12,5" ◆

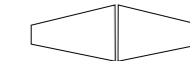

ÁNGULO PELDAÑO ANG.
32 x 45/3 (G 18 x 2PZ) 12,5" x 17,7"/1" ◆

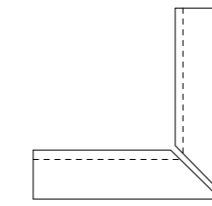

ÁNGULO PELDAÑO 120. INT
120 x 32 x 45/3 (G 46 x 2)
48" x 12,5" x 17,7"/1" ◆

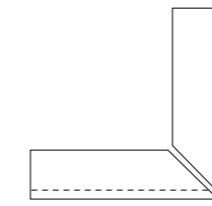

ÁNGULO PELDAÑO 120. EXT
120 x 32 x 45/3 (G 46 x 2)
48" x 12,5" x 17,7"/1" ◆

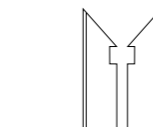

ZANQUÍN ANG. - IZQ. / DRCH.
9 x 30 (G 10) 3,5" x 11,8" ◆

PIEZAS ESPECIALES · SPECIAL PIECES

Disponibles en todos los colores · Available in all colors



PELDAÑO CURVO ANTISLIP
CLASE III
30 x 33/4 (G 17) 11,8" x 13"/1,5" ◆



ÁNG. PELD. CURVO
CLASE III
33 x 46/4 (G 18 x 2PZ) 13" x 18"/1,5" ◆

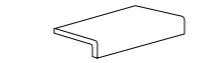

VIERTEAGUAS ANTISLIP
CLASE III
15 x 30/4 (G 12) 6" x 11,8"/1,5" ◆

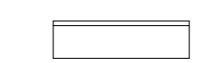

ZÓCALO
CLASE II
9 x 30 (G 06) 3,5" x 11,8" ◆

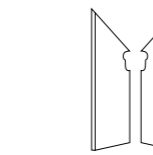

ZANQUÍN - IZQ. / DCHA.
CLASE II
9 x 30 (G 10) 3,5" x 11,8" ◆



CANALETA ANTISLIP (blanco)
13 x 7,5 x 50 (G 30) 5" x 3" x 19,5" ◆
20 x 14,5 x 50 (G 19) 8" x 5,7" x 19,5" ◆



REJILLA ANTISLIP
12,5 x 30/2,2 (G 57) 4,9" x 11,8"/1" ◆
12,5 x 60/2,2 (G 59) 4,9" x 23,6"/1" ◆



ESQUINA REJILLA ANTISLIP
12,5 x 12,5/2,2 (G 19) 4,9" x 4,9"/1" ◆

PACKING BASES

FORMATO	PULGADAS	PZ/CAJA	M²	CAJA/PLT	PESO/CAJA	PESO/PLT
30 x 60	11,8" x 23,6"	6	1,08	48	24,82	1.205

PACKING DECOR

FORMATO	PULGADAS	PZ/CAJA	ML	CAJA/PLT	PESO/CAJA	PESO/PLT
15,5 x 30	6" x 11,8"	15	4,5	56	14,9	850

PACKING PIEZAS ESPECIALES

FORMATO	PULGADAS	PZ/CAJA	ML	CAJA/PLT	PESO/CAJA	PESO/PLT
PELD. CURVO 30 x 33/4	11,8" x 13"/1,5"	4	1,2	54	11,94	660
ANG. PELD. CURVO 33 x 46/4	13" x 18"/1,5"	2	0,33	90	3,46	325
VIERTEAGUAS 15 x 30/4	6" x 11,8"/1,5"	14	4,2	36	20,54	760
ZÓCALO 9 x 30	3,5" x 11,8"	30	9	56	19,6	1.112
ZANQUÍN 9 x 30	3,5" x 11,8"	30	9	56	16,24	924
REJILLA 12,5 x 30/2,2	4,9" x 11,8"/1"	6	3,6	66	16,55	1.092
REJILLA 12,5 x 60/2,2	4,9" x 23,6"/1"	10	3	36	20,4	735
ESQUINA REJILLA 12,5 x 12,5/2,2	4,9" x 4,9"/1"	24	3	66	18,24	1.218
CANALETA 13 x 7,5 x 50	5" x 3" x 19,5"	24	12	20	13,5	300
CANALETA 20 x 14,5 x 50	8" x 5,7" x 19,5"	12	6	20	10,5	225



EVEREST SUR
CLASE II - R 9

EVEREST NIEVE
CLASE III - R 11



EVEREST CENTRO
CLASE II - R 9

EVEREST LLUVIA
CLASE III - R 11



EVEREST OESTE
CLASE II - R 9

EVEREST TIERRA
CLASE III - R 11



EVEREST ESTE
CLASE II - R 9

EVEREST PIEDRA
CLASE III - R 11

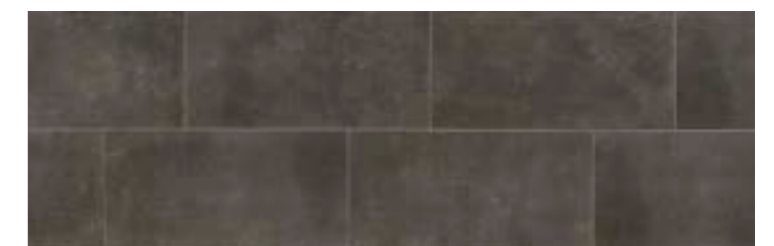

EVEREST NORTE
CLASE II - R 9

EVEREST GRAFITO
CLASE III - R 11

PACKING PIEZAS ESPECIALES

FORMATO	PULGADAS	PZ/CAJA	ML	CAJA/PLT	PESO/CAJA	PESO/PLT
PELDAÑO ANG. 120 x 32/3	48" x 12,5"/1"	2	2,4	14	19,20	283,8
PELDAÑO ANG. 60 x 32/3	23,6" x 12,5"/1"	2	1,2	28	9,60	283,8
ANG. PELDAÑO 120 INT 120 x 32 x 45/3	48" x 12,5" x 17,7"/1"	2	2,4	14	18	253
ANG. PELDAÑO 120 EXT 120 x 32 x 45/3	48" x 12,5" x 17,7"/1"	2	2,4	14	18	253
ANG. PELDAÑO ANG. 32 x 45/3	12,5" x 17,7"/1"	2	0,32	90	3,16	308
REMATE PELDAÑO 3 x 32	1" x 12,5"	20	6,4	60	3,5	219
ZANQUÍN ANG IZQ/DRCH 9 x 30	3,5" x 11,8"	30	9	48	16,24	794

ROCKS

fineRESISTANCE
R11 - Class III

EVOLUTION
EXTRUDED PORCELAIN TILE

ANTI-BACTERIAL
AntiSlip - R11

- RESISTE LA FLEXIÓN
32 N/mm2
- RESISTE EL DESGASTE
PEI (III - IV)
- RESISTE EL RAYADO
MOHS - 8
- ANTIDESLIZANTE
Class III - R11
- MANCHAS
Class 5 - Class A
- ABSORCIÓN
<0,5%
- DILATACIÓN
6,0° 10°/°C
- ANTIBACTERIANO
Norma JIS Z 2801

- GRES EXTRUSIONADO PORCELÁNICO
PORCELAIN EXTRUDED TILE
- PAV. DE EXTERIOR
OUTDOOR FLOOR TILE
- SUPERFICIE MATE
SURFACE MATT
- SIN MANTENIMIENTO
NO MAINTENANCE
- RES. A ÁCIDOS Y BASES
RES. TO ACIDS AND BASES
- RES. A LA HELADA
FROST PROOF
- DESTONIFICADO ARMONIOSO
CONTROLLED DESTONIFICATION



COLORES · COLORS

fineRESISTANCE ▶ R11 - Class III



ROCKS WHITE
30 x 60 (G 57) 11,8" x 23,6"

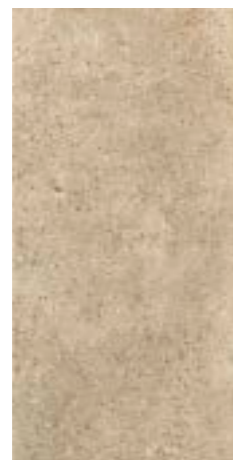

ROCKS BEIGE
30 x 60 (G 57) 11,8" x 23,6"

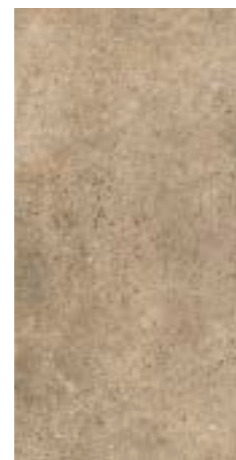

ROCKS BROWN
30 x 60 (G 57) 11,8" x 23,6"

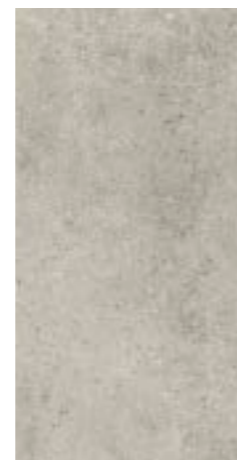

ROCKS GREY
30 x 60 (G 57) 11,8" x 23,6"



ROCKS DARK
30 x 60 (G 57) 11,8" x 23,6"



ROCKS WHITE
30 x 30 (G 25) 11,8" x 11,8"

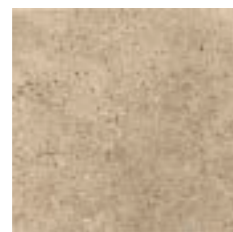

ROCKS BEIGE
30 x 30 (G 25) 11,8" x 11,8"



ROCKS BROWN
30 x 30 (G 25) 11,8" x 11,8"



ROCKS GREY
30 x 30 (G 25) 11,8" x 11,8"



ROCKS DARK
30 x 30 (G 25) 11,8" x 11,8"

PACKING BASES

FORMATO	PULGADAS	PZ/CAJA	M ²	CAJA/PLT	PESO/CAJA	PESO/PLT
30 x 30	11,8" x 11,8"	11	1	72	20,27	1.474
30 x 60	11,8" x 23,6"	6	1,08	48	24,82	1.205

PACKING PIEZAS ESPECIALES

FORMATO	PULGADAS	PZ/CAJA	ML	CAJA/PLT	PESO/CAJA	PESO/PLT
ZANQUÍN CV ANG. 9 x 30	3,5" x 11,8"	30	9	56	16,24	924
ZÓCALO 9 x 30	3,5" x 11,8"	30	9	56	19,6	1.112

PACKING PIEZAS ESPECIALES

FORMATO	PULGADAS	PZ/CAJA	ML	CAJA/PLT	PESO/CAJA	PESO/PLT
PELDAÑO ANG. 120 x 32/3	48" x 12,5"/1"	2	2,4	14	19,20	284
ANG. PELDAÑO 120 120 x 32 x 45/3	48" x 12,5" x 17,7"/1"	2	2,4	14	18	253
PELDAÑO ANG. 60 x 32/3	23,6" x 12,5"/1"	2	1,2	28	9,60	284
ANG. PELDAÑO ANG. 32 x 45/3	12,5" x 17,7"/1"	2	0,32	90	3,46	325
REMATE PELDAÑO 3 x 32	1" x 12,5"	20	6,4	60	3,5	219
BORDE PISCINA 30 x 36/4	11,8" x 14"/1,5"	3	0,9	44	15,7	691
BORDE PISC. ESQ. 51,2 x 51,2/4	20,1" x 20,1"/1,5"	1	0,51	18	12,71	245
DESBORDANTE 30 x 30/2,2	11,8" x 11,8"/1"	6	1,8	44	17,75	796
ESQ. DESB. 30 x 30 x 41,5/2,2	11,8" x 11,8" x 16"/1"	2	0,6	90	6,3	578

PIEZAS ESPECIALES · SPECIAL PIECES

Disponibile in WHITE y GREY · Available in WHITE & GREY

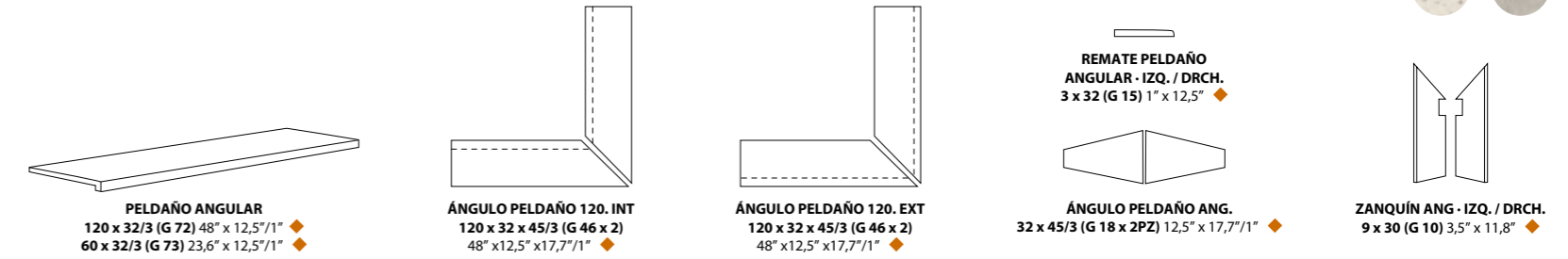

PIEZAS ESPECIALES · SPECIAL PIECES

Disponibile in todos los colores · Available in all colors

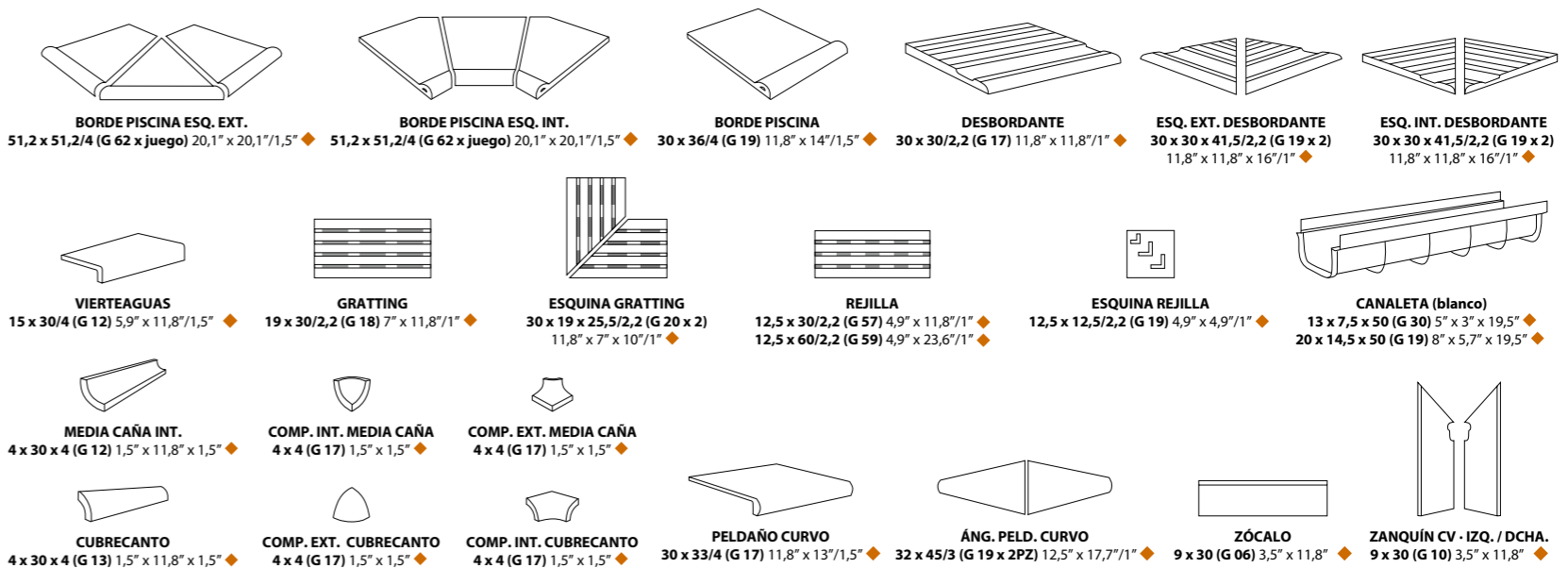

PACKING PIEZAS ESPECIALES

FORMATO	PULGADAS	PZ/CAJA	ML	CAJA/PLT	PESO/CAJA	PESO/PLT
PELD. CURVO 30 x 33/4	11,8" x 13"/1,5"	4	1,2	54	11,94	660
GRATTING 19 x 30/2,2	7" x 11,8"/1"	6	3,3	56	15	850
ESQ. GRATTING 30 x 19 x 25,5/2,2	11,8" x 7" x 10"/1"	6	3,3	56	11,4	640
REJILLA 12,5 x 60	4,9" x 23,6"/1"	6	3,6	66	16,55	1.092
REJILLA 12,5 x 30	4,9" x 11,8"/1"	10	3	36	20,4	735
ESQUINA REJILLA 12,5 x 12,5/2,2	4,9" x 4,9"/1"	24	3	66	18,24	1218
CANALETA 13 x 7,5 x 50	5" x 3" x 19,5"	24	12	20	13,5	300
CANALETA 20 x 14,5 x 50	8" x 5,7" x 19,5"	12	6	20	10,5	225
ANG. PELD. CURVO 33 x 46/4	13" x 18"/1,5"	2	0,33	90	3,46	325

PACKING PIEZAS ESPECIALES

FORMATO	PULGADAS	PZ/CAJA	ML	CAJA/PLT	PESO/CAJA	PESO/PLT
VIERTEGUAS 15 x 30/4	5,9" x 11,8"/1,5"	14	4,2	36	20,54	760
MEDIA CAÑA INT. 4 x 30 x 4	1,5" x 11,8" x 1,5"	22	6,6	-	9,91	-
COMP. EXT. MEDIA CA. 4 x 4	1,5" x 1,5"	18	0,6	-	1,34	-
COMP. INT. MEDIA CA. 4 x 4	1,5" x 1,5"	20	0,66	-	1,84	-
CUBRECANTO 4 x 30 x 4	1,5" x 11,8" x 1,5"	26	7,8	-	7,33	-
COMP. EXT. CUBRECAN. 4 x 4	1,5" x 1,5"	25	0,83	-	0,55	-
COMP. INT. CUBRECAN. 4 x 4	1,5" x 1,5"	10	0,33	-	0,85	-

TECH • GEO



14 mm
ESPOSOR



TECH GEO GLACIER 22,5 x 33 - 8,8" x 13" - TECH GEO GLACIER 22,5 x 22,5 - 8,8" x 8,8"
TECH GEO GLACIER 11 x 22,5 - 4,3" x 8,8"



TECH GEO RIVER 22,5 x 22,5 - 8,8" x 8,8" - TECH GEO RIVER 11 x 22,5 - 4,3" x 8,8"

COLORES • COLORS

14 mm
ESPOSOR



TECH GEO GLACIER
11 x 22,5 (G 39) 4,3" x 8,8" m



TECH GEO RIVER
11 x 22,5 (G 39) 4,3" x 8,8" m



TECH GEO MOUNTAIN
11 x 22,5 (G 39) 4,3" x 8,8" m



TECH GEO VOLCANO
11 x 22,5 (G 39) 4,3" x 8,8" m



TECH GEO GLACIER
22,5 x 22,5 (G 58) 8,8" x 8,8" m



TECH GEO RIVER
22,5 x 22,5 (G 58) 8,8" x 8,8" m



TECH GEO MOUNTAIN
22,5 x 22,5 (G 58) 8,8" x 8,8" m



TECH GEO VOLCANO
22,5 x 22,5 (G 58) 8,8" x 8,8" m



TECH GEO GLACIER
22,5 x 33 (G 58) 8,8" x 13" m

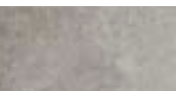

TECH GEO RIVER
22,5 x 33 (G 58) 8,8" x 13" m



TECH GEO MOUNTAIN
22,5 x 33 (G 58) 8,8" x 13" m



TECH GEO VOLCANO
22,5 x 33 (G 58) 8,8" x 13" m



TECH GEO MOUNTAIN 22,5 x 33 - 8,8" x 13" - TECH GEO MOUNTAIN 22,5 x 22,5 - 8,8" x 8,8"
TECH GEO MOUNTAIN 11 x 22,5 - 4,3" x 8,8"

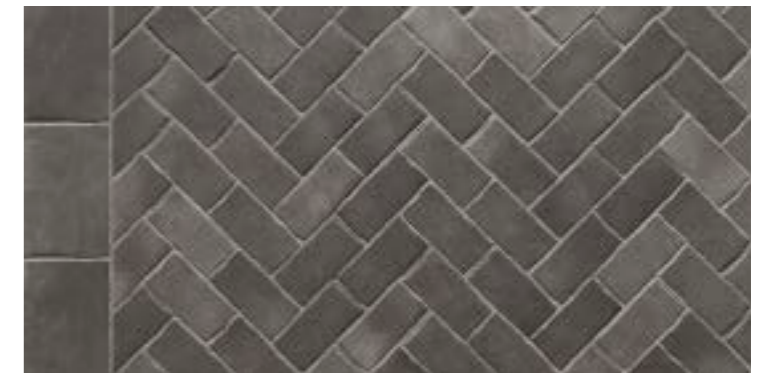

TECH GEO VOLCANO 22,5 x 22,5 - 8,8" x 8,8" - TECH GEO VOLCANO 11 x 22,5 - 4,3" x 8,8"

APLICACIONES • APPLICATIONS



ZONAS RESIDENCIALES
RESIDENTIAL AREAS



PASEOS URBANOS
URBAN AREAS



TERRAZAS Y PATIOS
TERRACE & PATIOS



ZONAS COMERCIALES
COMMERCIAL AREAS



PISCINAS
SWIMMING POOLS



JARDINES
GARDENS



ZONAS TRANSITABLES
HIGH TRAFFIC AREAS

PACKING BASES

FORMATO	PULGADAS	PZ/CAJA	M²	CAJA/PLT	PESO/CAJA	PESO/PLT
22,5 x 33	8,8" x 13"	11	0,82	68	23,80	1.640
22,5 x 22,5	8,8" x 8,8"	17	0,86	60	24,8	1.503
11 x 22,5	4,3" x 8,8"	20	0,5	112	13,7	1.550

PACKING PIEZAS ESPECIALES

FORMATO	PULGADAS	PZ/CAJA	ML	CAJA/PLT	PESO/CAJA	PESO/PLT
PELDAÑO CURVO 22,5 x 33/4	8,8" x 13"/1,5"	6	13,5	64	12	785
ÁNG. PELD. CURVO 33 x 46/4	13" x 18"/1,5"	2	0,33	90	3,46	325
ZÓCALO 9 x 30	3,5" x 11,8"	30	9	56	19,60	1.112
ZANQUÍN 9 x 30	3,5" x 11,8"	30	9	56	16,24	924

PIEZAS ESPECIALES • SPECIAL PIECES

Disponible en todos los colores • Available in all colors



PELDAÑO CURVO
22,5 x 33/4 (G 16) 8,8" x 13"/1,5" ◆



ÁNG. PELD. CURVO
33 x 46/4 (G 19 x 2PZ) 13" x 18"/1,5" ◆

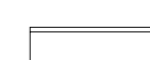

ZÓCALO
9 x 30 (G 06) 3,5" x 11,8" ◆

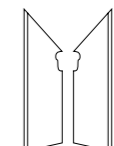

ZANQUÍN • IZQ. / DCHA.
9 x 30 (G 10) 3,5" x 11,8" ◆

MONTE



FORMATO
 30 x 60 - 11,8" x 23,6"
 30 x 30 - 11,8" x 11,8"
 10 x 60 - 4" x 23,6"
 HEX. 36 x 41,5 - 14" x 16,2"



PIEZAS ESPECIALES · SPECIAL PIECES

Disponible en BLAT & TORTOLA · Available in BLAT & TORTOLA

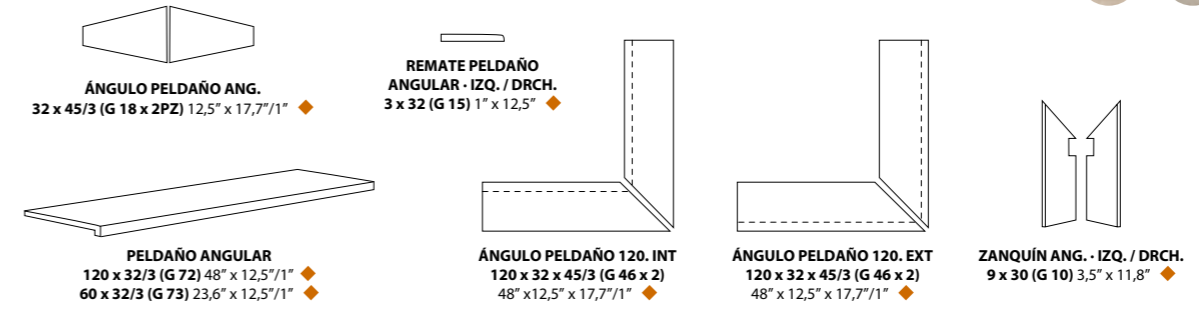

DECORACIÓN · DECORATION



FRONTAL STONE
 15,5 x 30 (G 12) 6" x 11,8"

PIEZAS ESPECIALES · SPECIAL PIECES

Disponible en todos los colores · Available in all colors

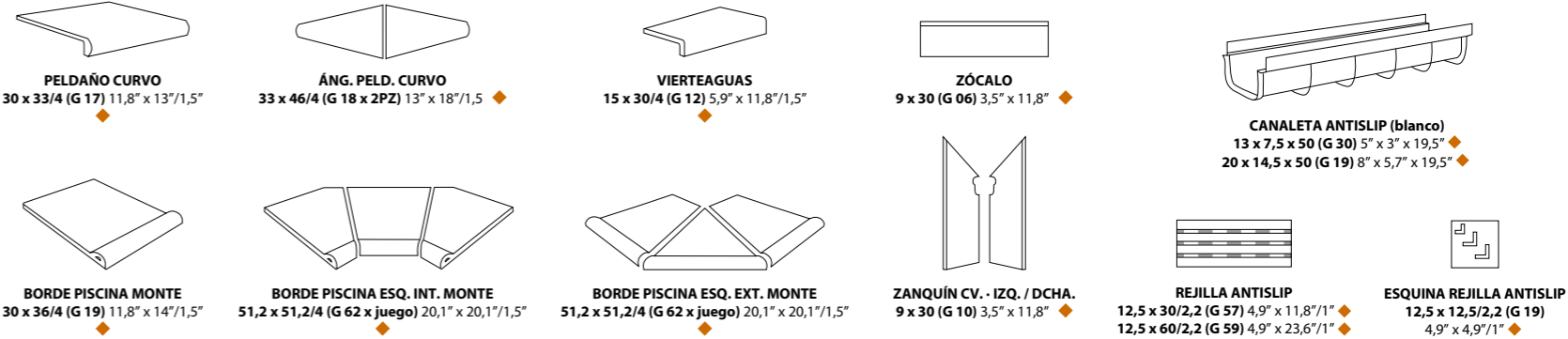

COLORES · COLORS



MONTE BLAT HEX.
 36 x 41,5 (G 58) 14" x 16,2"



MONTE CANYELLA HEX.
 36 x 41,5 (G 58) 14" x 16,2"



MONTE TORTOLA HEX.
 36 x 41,5 (G 58) 14" x 16,2"

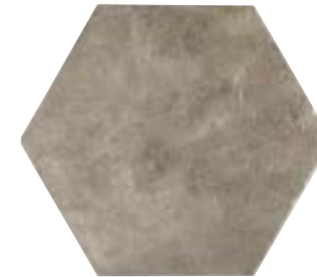

MONTE PEDRA HEX.
 36 x 41,5 (G 58) 14" x 16,2"



MONTE BLAT
 30 x 60 (G 38) 11,8" x 23,6"



MONTE BLAT
 30 x 30 (G 25) 11,8" x 11,8"



MONTE CANYELLA
 30 x 60 (G 38) 11,8" x 23,6"



MONTE CANYELLA
 30 x 30 (G 25) 11,8" x 11,8"



MONTE TORTOLA
 30 x 60 (G 38) 11,8" x 23,6"



MONTE TORTOLA
 30 x 30 (G 25) 11,8" x 11,8"



MONTE PEDRA
 30 x 60 (G 38) 11,8" x 23,6"



MONTE PEDRA
 30 x 30 (G 25) 11,8" x 11,8"



MONTE BLAT
 10 x 60 (G 27) 4" x 23,6"



MONTE CANYELLA
 10 x 60 (G 27) 4" x 23,6"



MONTE TORTOLA
 10 x 60 (G 27) 4" x 23,6"



MONTE PEDRA
 10 x 60 (G 27) 4" x 23,6"

PACKING BASES

FORMATO	PULGADAS	PZ/CAJA	M ²	CAJA/PLT	PESO/CAJA	PESO/PLT
30 x 30	11,8" x 11,8"	11	1	72	20,27	1474
30 x 60	11,8" x 23,6"	6	1,08	48	24,82	1.205
10 x 60	4" x 23,6"	16	0,96	72	20,9	1.519
HEX. 36 x 41,5	14" x 16,2"	9	1	48	22,6	1.103

PACKING DECORADO

FORMATO	PULGADAS	PZ/CAJA	ML	CAJA/PLT	PESO/CAJA	PESO/PLT
15,5 x 30	6" x 11,8"	15	4,5	56	14,9	850

PACKING PIEZAS ESPECIALES

FORMATO	PULGADAS	PZ/CAJA	M ² /ML	CAJA/PLT	PESO/CAJA	PESO/PLT
REJILLA 12,5 x 30/2,2	4,9" x 11,8"/1"	6	3,6	66	16,55	1.092
REJILLA 12,5 x 60/2,2	4,9" x 23,6"/1"	10	3	36	20,4	735
ESQUINA REJILLA 12,5 x 12,5/2,2	4,9" x 4,9"/1"	24	3	66	18,24	1218
CANALETA 13 x 7,5 x 50	5" x 3" x 19,5"	24	12	20	13,5	300
CANALETA 20 x 14,5 x 50	8" x 5,7" x 19,5"	12	6	20	10,5	225

PACKING PIEZAS ESPECIALES

FORMATO	PULGADAS	PZ/CAJA	M ² /ML	CAJA/PLT	PESO/CAJA	PESO/PLT
PELD. CURVO 30 x 33/4	11,8" x 13"/1,5"	4	1,2	54	11,94	660
ÁNG. PELD. CURVO 33 x 46/4	13" x 18"/1,5"	2	0,33	90	3,46	325
VIERTAGUAS 15 x 30/4	5,9" x 11,8"/1,5"	14	4,2	48	20,54	760
ZÓCALO 9 x 30	3,5" x 11,8"	30	9	56	19,6	1.112
ZANQUÍN 9 x 30	3,5" x 11,8"	30	9	56	16,24	924
BORDE PISCINA 30 x 36/4	11,8" x 14"/1,5"	3	0,9	40	15,7	643
BORDE PISC. ESQ. EXT. 51,2 x 51,2/4	20,1" x 20,1"/1,5"	1	0,51	18	12,71	245

PACKING PIEZAS ESPECIALES

FORMATO	PULGADAS	PZ/CAJA	M ² /ML	CAJA/PLT	PESO/CAJA	PESO/PLT
BORDE PISC. INT. 51,2 x 51,2/4	20,1" x 20,1"/1,5"	1	0,51	18	12,71	245
PELDAÑO ANG. 120 x 32/3	48" x 12,5"/1"	2	2,4	14	19,20	284
ÁNG. PELDAÑO 120 x 120 x 45/3	48" x 12,5" x 17,7"/1"	2	2,4	14	18	253
PELDAÑO ANG. 60 x 32/3	23,6" x 12,5"/1"	2	1,2	28	9,60	284
ÁNG. PELDAÑO ANG. 32 x 45/3	12,5" x 17,7"/1"	2	0,32	90	3,46	325
REMATE PELDAÑO 3 x 32	1" x 12,5"	20	6,4	60	3,5	219

GRANITE



RESISTE LA FLEXIÓN	RESISTE EL DESGASTE	RESISTE EL RAYADO	ANTIDESLIZANTE	ANTID. TORUS	MANCHAS	ABSORCIÓN	DILATACIÓN
34 N/m ²	PEI (IV)	MOHS - 9	Class III - R12	0,82 - 0,77	Class 5 - Class A	0,2%	5,7° 10° / °C

GRES EXTRUSIONADO PORCELÁNICO PORCELAIN EXTRUDED TILE	PAV. DE EXTERIOR OUTDOOR FLOOR TILE	MODULARIDAD MODULARITY	SUPERFICIE MATE SURFACE MATT	SIN MANTENIMIENTO NO MAINTENANCE	RES. A ÁCIDOS Y BASES RES. TO ACIDS AND BASES	RES. A LA HELADA FROST PROOF	DESTONIFICADO ARMONIOSO CONTROLLED DESTONIFICATION



MODULACIÓN · MODULATION

Disponible en todos los colores · Available in all colors

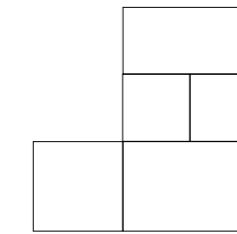

GRANITE MODULO A (G 38)
packing: 0,86 m²/caja

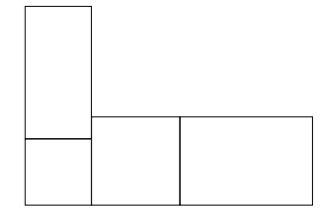

GRANITE MODULO B (G 38)
packing: 1,13 m²/caja

ENMALLADOS · ON A MESH

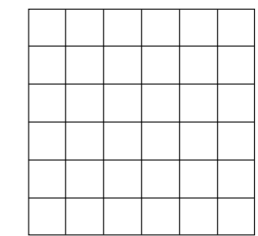

GRANITE ENMALLADO EXT. R12
30 x 30 (G 18) 11,8" x 11,8"

COLORES · COLORS

GRANITE CARRARA 30 x 30 (G 25) 11,8" x 11,8"	GRANITE CARRARA 22,5 x 22,5 (G 25) 8,8" x 8,8"	GRANITE LIVORNO 30 x 30 (G 25) 11,8" x 11,8"	GRANITE LIVORNO 22,5 x 22,5 (G 25) 8,8" x 8,8"	GRANITE GROSSETO 30 x 30 (G 25) 11,8" x 11,8"	GRANITE GROSSETO 22,5 x 22,5 (G 25) 8,8" x 8,8"
GRANITE CARRARA 22,5 x 45 (G 25) 8,8" x 17,7"	GRANITE LIVORNO 22,5 x 45 (G 25) 8,8" x 17,7"	GRANITE GROSSETO 22,5 x 45 (G 25) 8,8" x 17,7"			
GRANITE CARRARA 30 x 45 (G 57) 11,8" x 17,7"	GRANITE LIVORNO 30 x 45 (G 57) 11,8" x 17,7"	GRANITE GROSSETO 30 x 45 (G 57) 11,8" x 17,7"			

PIEZAS ESPECIALES · SPECIAL PIECES

Disponible en todos los colores · Available in all colors



PELDAÑO CURVO EXT. R12
30 x 33/4 (G 17) 11,8" x 13"/1,5"



ÁNG. PELD. CURVO EXT. R12
33 x 46/4 (G 18 x 2PZ) 13" x 18"/1,5"

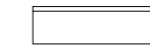

ZÓCALO
9 x 30 (G 06) 3,5" x 11,8"
9 x 22,5 (G 05) 3,5" x 8,8"

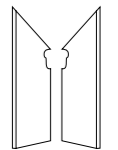

ZANQUÍN - IZQ. / DCHA.
9 x 30 (G 10) 3,5" x 11,8"

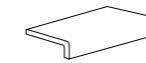

VIERTEAGUAS EXT. R12
15 x 30/4 (G 12) 5,9" x 11,8"/1,5"
15 x 22,5/4 (G 10) 5,9" x 8,8"/1,5"

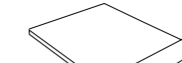

BORDE PISCINA EXT. R12
30 x 36/4 (G 19) 11,8" x 14"/1,5"



BORDE PISCINA ESQ. INT. EXT. R12
51,2 x 51,2/4 (G 62 x juego) 20,1" x 20,1"/1,5"

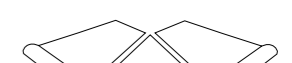

BORDE PISCINA ESQ. EXT. R12
51,2 x 51,2/4 (G 62 x juego) 20,1" x 20,1"/1,5"

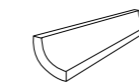

MEDIA CAÑA INT. GRANITE
4 x 30 x 4 (G 12) 1,5" x 11,8" x 1,5"



COMP. INTERIOR
MEDIA CAÑA GRANITE
4 x 4 (G 17) 1,5" x 1,5"



COMP. EXTERIOR
MEDIA CAÑA GRANITE
4 x 4 (G 17) 1,5" x 1,5"

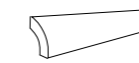

CUBRECANTO GRANITE
4 x 30 x 4 (G 13) 1,5" x 11,8" x 1,5"



COMP. EXTERIOR
CUBRECANTO GRANITE
4 x 4 (G 17) 1,5" x 1,5"



COMP. INTERIOR
CUBRECANTO GRANITE
4 x 4 (G 17) 1,5" x 1,5"

PACKING BASES

FORMATO	PULGADAS	PZ/CAJA	M ²	CAJA/PLT	PESO/CAJA	PESO/PLT
30 x 45	11,8" x 17,7"	8	1,08	48	22,9	1.113
30 x 30	11,8" x 11,8"	11	1	72	20,27	1474
22,5 x 45	8,8" x 17,7"	10	1,01	72	20,97	1524
22,5 x 22,5	8,8" x 8,8"	20	1,01	72	20,74	1.507
30 x 30 ENML.	11,8" x 11,8"	11	1	72	22,43	1.629

PACKING BASES

FORMATO	PULGADAS	PZ/CAJA	M ²	CAJA/PLT	PESO/CAJA	PESO/PLT
MODULO A	-	10	0,86	48	16,21	888
MODULO B	-	12	1,13	40	24,1	978

PACKING PIEZAS ESPECIALES

FORMATO	PULGADAS	PZ/CAJA	ML	CAJA/PLT	PESO/CAJA	PESO/PLT
ANG. PELD. CURVO 33 x 46/4	13" x 18"/1,5"	2	0,33	90	3,46	325
PELD. CURVO 30 x 33/4	11,8" x 13"/1,5"	4	1,2	54	11,94	660
VIERTEAGUAS 15 x 30/4	5,9" x 11,8"/1,5"	14	4,2	36	20,54	760
VIERTEAGUAS 15 x 22,5/4	5,9" x 8,8"/1,5"	14	3,15	48	15,08	739
BORDE PISCINA 30 x 36/4	11,8" x 14"/1,5"	3	0,9	40	15,7	643
BORDE PISC. ESQ. EXT. 51,2 x 51,2/4	20,1" x 20,1"/1,5"	1	0,51	18	12,71	245
BORDE PISC. ESQ. INT. 51,2 x 51,2/4	20,1" x 20,1"/1,5"	1	0,51	18	12,71	245
MEDIA CAÑA INT. 4 x 30 x 4	1,5" x 11,8" x 1,5"	22	6,6	-	9,91	-

PACKING PIEZAS ESPECIALES

FORMATO	PULGADAS	PZ/CAJA	ML	CAJA/PLT	PESO/CAJA	PESO/PLT
COMP. EXT. MEDIA CA. 4 x 4	1,5" x 1,5"	18	0,6	-	1,34	-
COMP. INT. MEDIA CA. 4 x 4	1,5" x 1,5"	20	0,66	-	1,84	-
CUBRECANTO 4 x 30 x 4	1,5" x 11,8" x 1,5"	26	7,8	-	7,33	-
COMP. EXT. CUBRECANTO 4 x 4	1,5" x 1,5"	25	0,83	-	0,55	-
COMP. INT. CUBRECANTO 4 x 4	1,5" x 1,5"	10	0,33	-	0,85	-
ZANQUIN 9 x 30	3,5" x 11,8"	30	9	56	16,24	924
ZÓCALO 9 x 30	3,5" x 11,8"	30	9	56	19,6	1.112
ZÓCALO 9 x 22,5	3,5" x 8,8"	40	9	60	19,7	1.197

Pietra di
Firenze

fine **RESISTANCE**
R12 - CLASS III

EVOLUTIO
EXTRUDED PORCELAIN TILE

AntiSlip

RESISTE LA FLEXIÓN 33 N/m2	RESISTE EL DESGASTE PEI (III - IV)	RESISTE EL RAYADO MOHS - 9	ANTIDESLIZANTE Class III - R12	ANTID. TORUS 0,88 - 0,85	MANCHAS Class 5 - Class A	ABSORCIÓN 0,1%	DILATACIÓN 6,5* 10 ⁻⁶ / °C

GRES EXTRUSIONADO PORCELÁNICO PORCELAIN EXTRUDED TILE	PAV. DE EXTERIOR OUTDOOR FLOOR TILE	SUPERFICIE MATE SURFACE MATT	SIN MANTENIMIENTO NO MAINTENANCE	RES. A ÁCIDOS Y BASES RES. TO ACIDS AND BASES	RES. A LA HELADA FROST PROOF	DESTONIFICADO ARMONIOSO CONTROLLED DESTONIFICATION

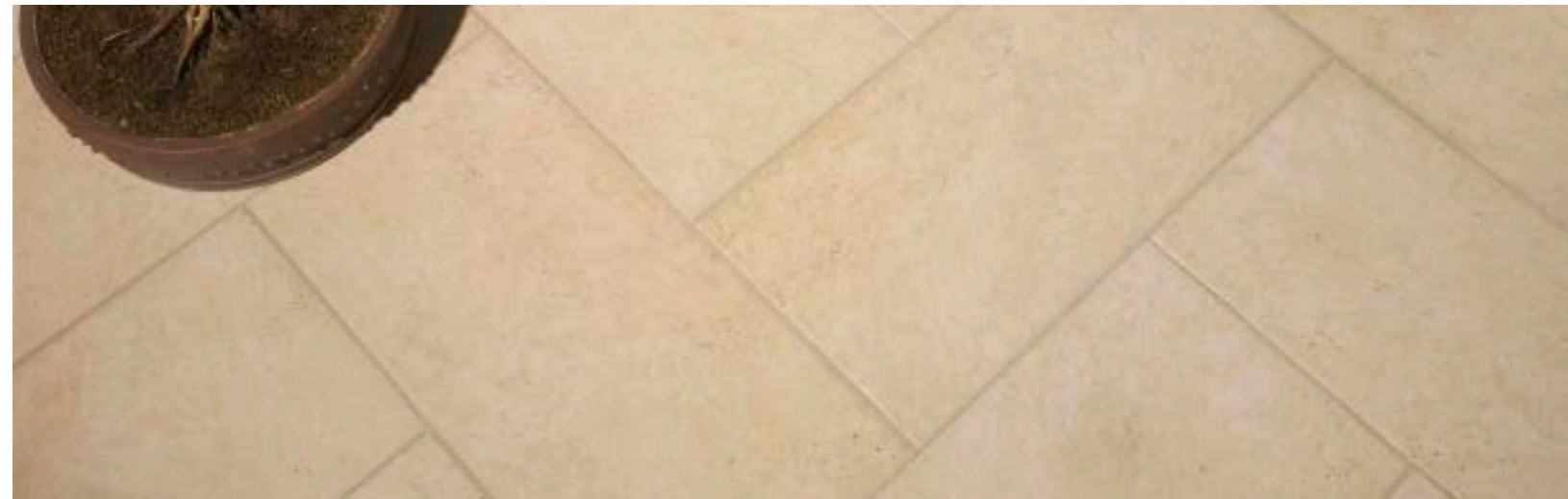

COLORES · COLORS

fine **RESISTANCE** ▶ R12 - Class III

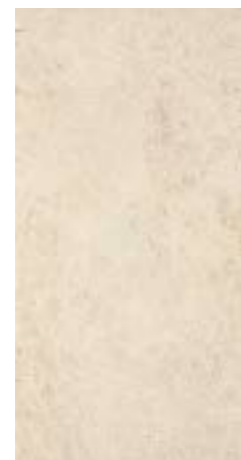

PIETRA DI FIRENZE ALBINO
30 x 60 (G 56) 11,8" x 23,6" m²

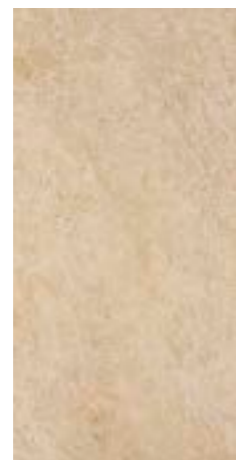

PIETRA DI FIRENZE NOCCIOLA
30 x 60 (G 56) 11,8" x 23,6" m²

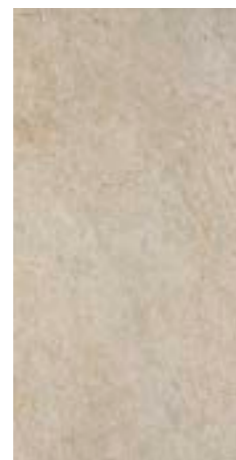

PIETRA DI FIRENZE GIADA
30 x 60 (G 56) 11,8" x 23,6" m²

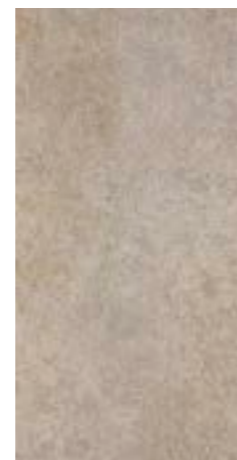

PIETRA DI FIRENZE NEBBIA
30 x 60 (G 56) 11,8" x 23,6" m²

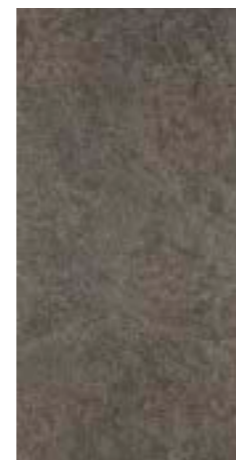

PIETRA DI FIRENZE NERO
30 x 60 (G 56) 11,8" x 23,6" m²

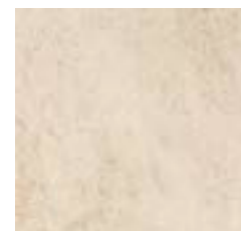

PIETRA DI FIRENZE ALBINO
30 x 30 (G 25) 11,8" x 11,8" m²

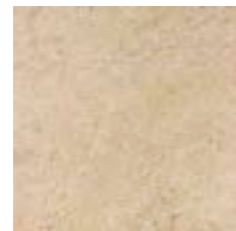

PIETRA DI FIRENZE NOCCIOLA
30 x 30 (G 25) 11,8" x 11,8" m²

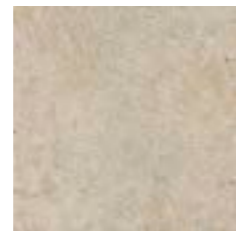

PIETRA DI FIRENZE GIADA
30 x 30 (G 25) 11,8" x 11,8" m²

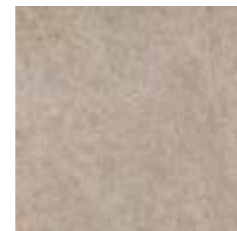

PIETRA DI FIRENZE NEBBIA
30 x 30 (G 25) 11,8" x 11,8" m²

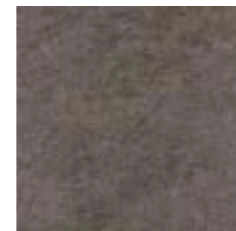

PIETRA DI FIRENZE NERO
30 x 30 (G 25) 11,8" x 11,8" m²

PACKING BASES

FORMATO	PULGADAS	PZ/CAJA	M ²	CAJA/PLT	PESO/CAJA	PESO/PLT
30 x 60	11,8" x 23,6"	6	1,08	48	24,82	1.205
30 x 30	11,8" x 11,8"	11	1	72	20,27	1474
ENM. 30 x 30	11,8" x 11,8"	11	1	72	18,36	1.336

PACKING PIEZAS ESPECIALES

FORMATO	PULGADAS	PZ/CAJA	ML	CAJA/PLT	PESO/CAJA	PESO/PLT
ANG. PELD. 33 x 46/4	13" x 18"/1,5"	2	0,33	90	3,46	325
PELD. CURVO 30 x 33/4	11,8" x 13"/1,5"	4	1,2	54	11,94	660
VIERTEAGUAS 15 x 30/4	5,9" x 11,8"/1,5"	14	4,2	36	20,54	760
ZANQUÍN 9 x 30	3,5" x 11,8"	30	9	56	16,24	924
ZÓCALO 9 x 30	3,5" x 11,8"	30	9	56	19,6	1.112

ENMALLADOS · ON A MESH

Disponible en todos los colores · Available in all colors



ENMALLADO PIETRA DI FIRENZE
30 x 30 (G 17) 11,8" x 11,8" m²

PIEZAS ESPECIALES · SPECIAL PIECES

Disponible en todos los colores · Available in all colors

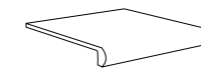

PELDAÑO CURVO
30 x 33/4 (G 17) 11,8" x 13"/1,5"

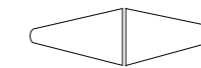

ÁNGULO PELDAÑO
33 x 46/4 (G 19 x 2PZ) 13" x 18"/1,5"



VIERTEAGUAS
15 x 30/4 (G 12) 5,9" x 11,8"/1,5"

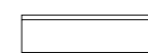

ZÓCALO
9 x 30 (G 06) 3,5" x 11,8"

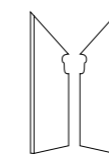

ZANQUÍN - IZQ. / DCHA.
9 x 30 (G 10) 3,5" x 11,8"

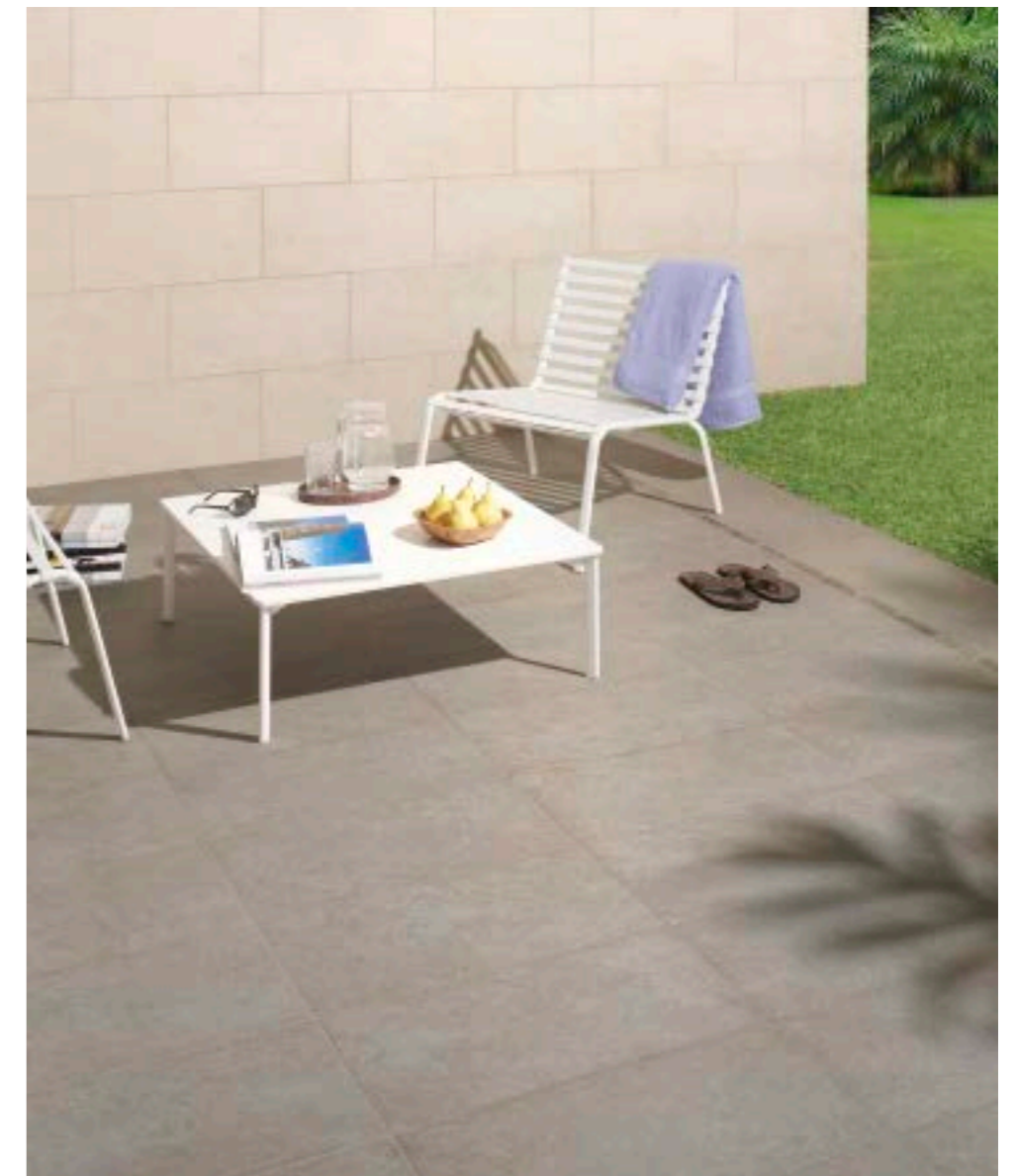

FUERZA DE ROTURA	RESISTE LA FLEXIÓN	RESISTE EL DESGASTE	RESISTE EL RAYADO	ANTIDESLIZANTE	ANTID.TORUS	MANCHAS	ABSORCIÓN	DILATACIÓN
3306 Nw	30 N/mn2	PEI (III - IV)	MOHS - 9	Class III - R12	0,93 - 0,85	Class 5 - Class A	0,1%	6,6° 10° / °C

14,2 mm
ESPESOR

GRES EXTRUS. PORCELÁNICO PORCELAIN EXTRUDED TILE	PAV. DE EXTERIOR OUTDOOR FLOOR TILE	PAV. DE INTERIOR INDOOR FLOOR TILE	SUPERFICIE SEMIBRILLO SURFACE SEMI-GLOSS	SIN MANTENIMIENTO NO MAINTENANCE	RES. A ÁCIDOS Y BASES RES. TO ACIDS AND BASES	RES. A LA HELADA FROST PROOF	DESTONIFICADO ARMONIOSO CONTROLLED DESTONIFICATION
---	--	---------------------------------------	---	-------------------------------------	--	---------------------------------	---

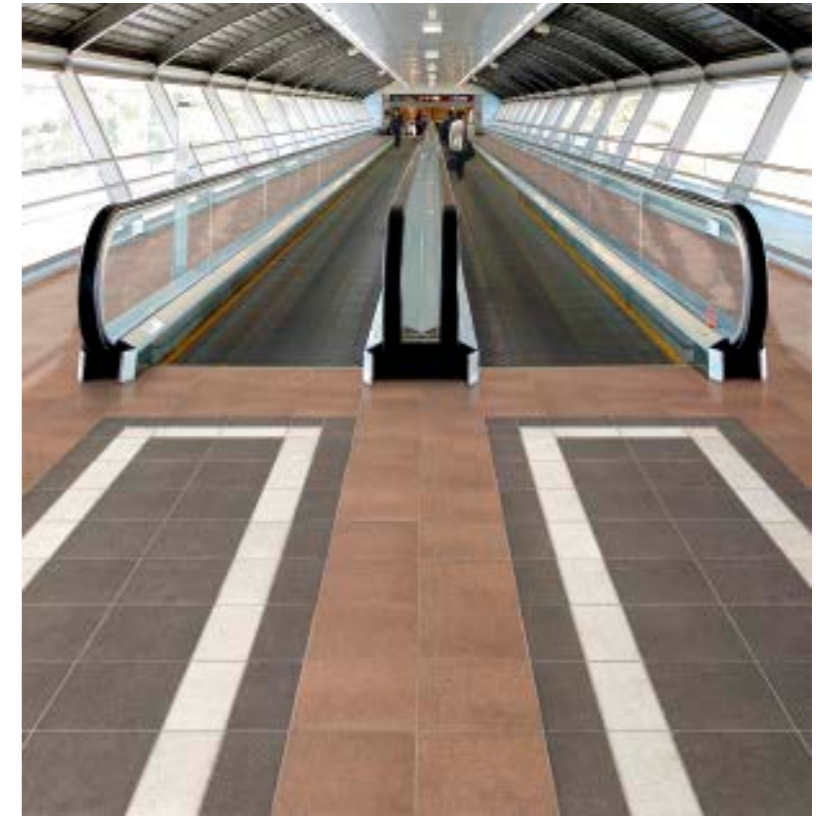

COLORES · COLORS

14,2 mm
ESPESOR

QUARTZ KLINKER LATTEO 15 x 15 (G 39) 5,9" x 5,9"	QUARTZ KLINKER RUTILO 15 x 15 (G 39) 5,9" x 5,9"	QUARTZ KLINKER CITRINO 15 x 15 (G 39) 5,9" x 5,9"	QUARTZ KLINKER FUME 15 x 15 (G 39) 5,9" x 5,9"	QUARTZ KLINKER GALENA 15 x 15 (G 39) 5,9" x 5,9"
QUARTZ KLINKER LATTEO 15 x 30 (G 38) 5,9" x 11,8"	QUARTZ KLINKER RUTILO 15 x 30 (G 38) 5,9" x 11,8"	QUARTZ KLINKER CITRINO 15 x 30 (G 38) 5,9" x 11,8"	QUARTZ KLINKER FUME 15 x 30 (G 38) 5,9" x 11,8"	QUARTZ KLINKER GALENA 15 x 30 (G 38) 5,9" x 11,8"
QUARTZ KLINKER LATTEO 30 x 30 (G 38) 11,8" x 11,8"	QUARTZ KLINKER RUTILO 30 x 30 (G 38) 11,8" x 11,8"	QUARTZ KLINKER CITRINO 30 x 30 (G 38) 11,8" x 11,8"	QUARTZ KLINKER FUME 30 x 30 (G 38) 11,8" x 11,8"	QUARTZ KLINKER GALENA 30 x 30 (G 38) 11,8" x 11,8"

APLICACIONES · APPLICATIONS

ZONAS RESIDENCIALES RESIDENTIAL AREAS	PASEOS URBANOS URBAN AREAS	TERRAZAS Y PATIOS TERRACE & PATIOS	ZONAS COMERCIALES COMMERCIAL AREAS	PISCINAS SWIMMING POOLS	JARDINES GARDENS	ZONAS TRANSITABLES HIGH TRAFFIC AREAS
--	-------------------------------	---------------------------------------	---------------------------------------	----------------------------	---------------------	--

PIEZAS ESPECIALES · SPECIAL PIECES

Disponible en todos los colores · Available in all colors

ZÓCALO 9 x 30 (G 06) 3,5" x 11,8"	VIERTEAGUAS 15 x 30/4 (G 12) 5,9" x 11,8"/1,5"	ZANQUÍN · IZQ. / DRCH. 9 x 30 (G 10) 3,5" x 11,8"
PELDAÑO ANGULAR 30 x 32/4 (G 17) 11,8" x 12,5"/1,5"	ÁNGULO PELDAÑO ANGULAR 32 x 45/4 (G 18 x 2PZ) 12,5" x 17,7"/1,5"	COMP. EXT. CUBRECANTO 4 x 4 (G 17) 1,5" x 1,5"
CUBRECANTO 4 x 30 x 4 (G 13) 1,5" x 11,8" x 1,5"	COMP. INT. CUBRECANTO 4 x 4 (G 17) 1,5" x 1,5"	COMP. INT. CUBRECANTO 4 x 4 (G 17) 1,5" x 1,5"
MEDIA CAÑA INTERIOR 4 x 30 x 4 (G 12) 1,5" x 11,8" x 1,5"	COMP. INT. MEDIA CAÑA 4 x 4 (G 17) 1,5" x 1,5"	COMP. EXT. MEDIA CAÑA 4 x 4 (G 17) 1,5" x 1,5"
ZÓCALO ANGULAR 9,5 x 30 x 4 (G 16) 4" x 11,8" x 1,5"	ESQUINA INT. ZÓCALO ANGULAR 9,5 x 4 (G 17) 4" x 1,5"	ESQUINA EXT. ZÓCALO ANGULAR 9,5 x 4 (G 17) 4" x 1,5"

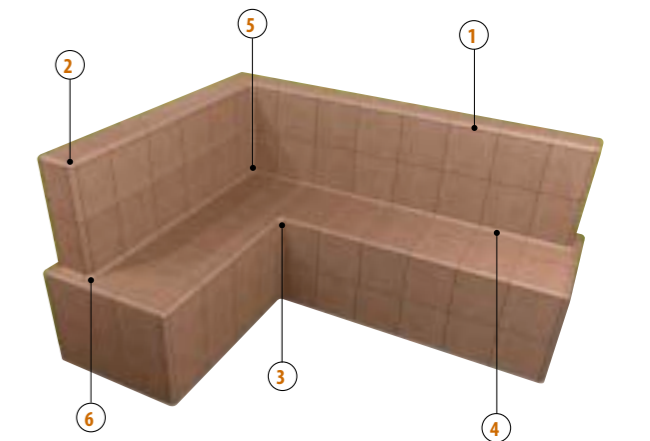

PACKING BASES

FORMATO	PULGADAS	PZ/CAJA	M²	CAJA/PLT	PESO/CAJA	PESO/PLT
GROSSO 30 x 30	11,8" x 11,8"	10	0,9	60	25	1.520
GROSSO 15 x 30	5,9" x 11,8"	20	0,9	54	25	1.369
GROSSO 15 x 15	5,9" x 5,9"	22	0,5	80	13,74	1.113

PACKING PIEZAS ESPECIALES

FORMATO	PULGADAS	PZ/CAJA	ML	CAJA/PLT	PESO/CAJA	PESO/PLT
ZÓCALO 9 x 30	3,5" x 11,8"	30	9	56	19,6	1.112
ZANQUÍN 9 x 30	3,5" x 11,8"	30	9	56	16,24	924
PELD. ANG. 30 x 32/4	11,8" x 12,5"/1,5"	4	1,2	54	11,94	660
ANG. PELD. ANG. 32 x 45/4	12,5" x 17,7"/1,5"	2	0,32	90	3,46	308
VIERTEAGUAS 15 x 30/4	5,9" x 11,8"/1,5"	14	4,2	36	20,54	760

PACKING PIEZAS ESPECIALES

FORMATO	PULGADAS	PZ/CAJA	ML	CAJA/PLT	PESO/CAJA	PESO/PLT
ZÓCALO ANG. 9,5 x 30 x 4	4" x 11,8" x 1,5"	10	3	50	8,5	440
ESQ. INT. ZOC. ANG 9,5 x 4	4" x 1,5"	10	0,4	-	1,28	-
ESQ. EXT. ZOC. ANG 9,5 x 4	4" x 1,5"	6	0,24	-	1,17	-
CUBRECANTO 4 x 30 x 4	1,5" x 11,8" x 1,5"	26	7,8	-	7,33	-
COMP. EXT. CUBRE. 4 x 4	1,5" x 1,5"	25	0,83	-	0,55	-

PACKING PIEZAS ESPECIALES

FORMATO	PULGADAS	PZ/CAJA	ML	CAJA/PLT	PESO/CAJA	PESO/PLT
COMP. INT. CUBRE. 4 x 4	1,5" x 1,5"	10	0,33	-	0,85	-
MEDIA CAÑA INT. 4 x 30 x 4	1,5" x 11,8" x 1,5"	22	6,6	-	9,91	-
COMP. EXT. MEDIA CA. 4 x 4	1,5" x 1,5"	18	0,6	-	1,34	-
COMP. INT. MEDIA CA. 4 x 4	1,5" x 1,5"	20	0,66	-	1,84	-

CUARCITA

fine **RESISTANCE**
R11 - Class III

EVOLUTION
EXTRUDED PORCELAIN TILE

in & out
INTERIOR - EXTERIOR

AntiSlip



FUERZA DE ROTURA
1143 Nw



CARGA DE ROTURA
1241 Nw



RESISTE LA FLEXIÓN
36 N/mm2



RESISTE EL DESGASTE
PEI (III)



RESISTE EL RAYADO
MOHS - 8



ANTIDESLIZANTE
Class III - R11



ANTID.TORUS
0,82 - 0,77



MANCHAS
Class 5
Class A



ABSORCIÓN
0,1%



DILATACIÓN
5,7° 10° / °C

PE GRES EXTRUSIONADO PORCELÁNICO
PORCELAIN EXTRUDED TILE

PAV. DE EXTERIOR
OUTDOOR FLOOR TILE

SUPERFICIE SEMIBRILLO
SURFACE SEMI-GLOSS

SIN MANTENIMIENTO
NO MAINTENANCE

RES. A ÁCIDOS Y BASES
RES. TO ACIDS AND BASES

RES. A LA HELADA
FROST PROOF

DESTONIFICADO ARMONIOSO
CONTROLLED DESTONIFICATION



COLORES · COLORS

fine **RESISTANCE** ▶ R11 - Class III



CUARCITA BEIGE
30 x 30 (G 22) 11,8" x 11,8" m²

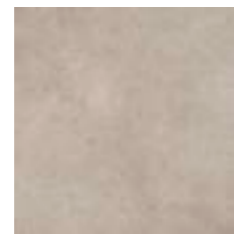

CUARCITA GRIS
30 x 30 (G 22) 11,8" x 11,8" m²



CUARCITA MARRÓN
30 x 30 (G 22) 11,8" x 11,8" m²



CUARCITA ANTRACITA
30 x 30 (G 22) 11,8" x 11,8" m²

PIEZAS ESPECIALES · SPECIAL PIECES

Disponibles en todos los colores · Available in all colors



PELDAÑO CURVO
30 x 33/4 (G 17) 11,8" x 13"/1,5" ◆



ÁNGULO PELDAÑO
33 x 46/4 (G 18 x 2PZ) 13" x 18"/1,5" ◆

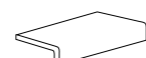

VIERTEGUAS
15 x 30/4 (G 12) 6" x 11,8"/1,5" ◆



ZÓCALO
9 x 30 (G 06) 3,5" x 11,8" ◆

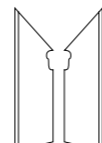

ZANQUÍN - IZQ. / DCHA.
9 x 30 (G 10) 3,5" x 11,8" ◆

PACKING BASES

FORMATO	PULGADAS	PZ/CAJA	M ²	CAJA/PLT	PESO/CAJA	PESO/PLT
30 x 30	11,8" x 11,8"	15	1,35	72	21,70	1580

PACKING PIEZAS ESPECIALES

FORMATO	PULGADAS	PZ/CAJA	ML	CAJA/PLT	PESO/CAJA	PESO/PLT
PELD. CURVO 30 x 33/4	11,8" x 13"/1,5"	4	1,2	54	11,94	660
VIERTEGUAS 15 x 30/4	6" x 11,8"/1,5"	14	4,2	36	20,54	760
ÁNGULO PELD. 33 x 46/4	13" x 18"/1,5"	2	0,33	90	3,46	325
ZÓCALO 9 x 30	3,5" x 11,8"	30	9	56	19,6	1.112
ZANQUÍN 9 x 30	3,5" x 11,8"	30	9	56	16,24	924



TECH·LAND

fine **RESISTANCE**
EVOLUTION
 EXTRUDED PORCELAIN TILE
 CLASE III-R11
 SOFT

in & out
 INTERIOR - EXTERIOR
ANTI-BACTERIAL

14 mm
 ESPESOR
 THICKNESS

PE GRES EXTR. PORCELÁNICO
 PORCELAIN EXTRUDED TILE
 PAV. DE INTERIOR
 INDOOR FLOOR TILE
 PAVIMENTO DE EXTERIOR
 OUTDOOR FLOOR TILE

SUPERFICIE MATE
 MATT SURFACE
SIN MANTENIMIENTO
 NO MAINTENANCE
RESIST. A LA HELADA
 FROST PROOF
RESIST. A ÁCIDOS Y BASES
 RESIST. TO ACIDS & BASES
DESTONIFICADO ARMONIOSO
 CONTROLLED DESTONIFICATION

FUERZA DE ROTURA
 3119 Nw
CARGA DE ROTURA
 3408 Nw
RESISTE LA FLEXIÓN
 28 N/mm2
RESISTE EL DESGASTE
 PEI (II-III)
RESISTE EL RAYADO
 MOHS - 8
ANTIDESLIZANTE
 Clase III - R11
ANTID. DCOF.
 0,69
ANTID. DIN 51097
 Clase C > 37°
MANCHAS
 Class 5 - Class A
ABSORCIÓN
 0,3%
DILATACIÓN
 6,6° 10° / °C
ANTIBACTERIANO
 Norma IIS Z 2801

FORMATOS
 11 x 22,5 - 4,3" x 8,8"
 22,5 x 22,5 - 8,8" x 8,8"
 22,5 x 33 - 8,8" x 13"
 30 x 30 - 11,8" x 11,8"
 7 x 60 - 3" x 23,6"
ARROW 7 x 33,5 - 3" x 13,1"
HEX. 18 x 20,5 - 7" x 8"
 15,5 x 15,5 - 6" x 6"



TECH LAND FIRE



DECORADOS · DECORATION

EVOLUTION
 EXTRUDED PORCELAIN TILE
 PINTADO A MANO



DECORACIÓN · DECORATION

Decoración serie TECH LAND completa en pág. 82-85
 Complete TECH LAND decor on pág. 82-85

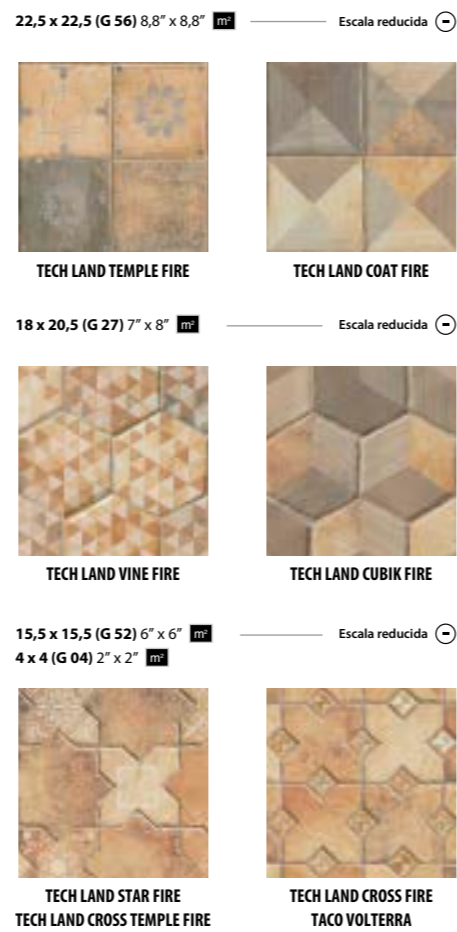

TECH LAND NATURAL



DECORACIÓN · DECORATION

Decoración serie TECH LAND completa en pág. 86-87
 Complete TECH LAND decor on pág. 86-87

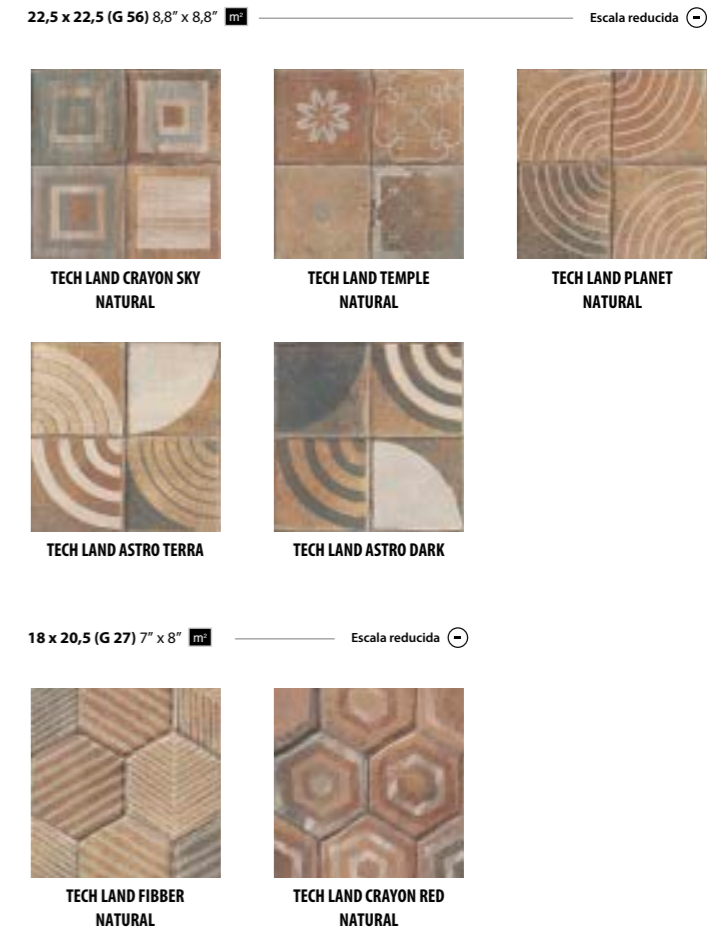

PACKING DECORADO

FORMATO	PULGADAS	PZ/CAJA	M ²	CAJA/PLT	PESO/CAJA	PESO/PLT
TACO 6,5 x 6,5	3" x 3"	60	3,9	60	5,02	-
TACO 4 x 4	2" x 2"	50	2	60	2,1	-

PACKING BASES

FORMATO	PULGADAS	PZ/CAJA	M ²	CAJA/PLT	PESO/CAJA	PESO/PLT
7 x 60	3" x 23,6"	16	0,68	66	19,52	1.304
STAR 15,5 x 15,5	6" x 6"	12	0,34	96	9,9	966
CROSS 15,5 x 15,5	6" x 6"	18	0,44	105	10,40	1.107

PACKING BASES

FORMATO	PULGADAS	PZ/CAJA	M ²	CAJA/PLT	PESO/CAJA	PESO/PLT
30 x 30	11,8" x 11,8"	10	0,90	60	25	1.520
ARROW 7 x 33,5	3" x 13,1"	36	0,85	48	23,68	1.152
HEX. 18 x 20,5	7" x 8"	30	0,83	48	22,57	1.098

PACKING BASES

FORMATO	PULGADAS	PZ/CAJA	M ²	CAJA/PLT	PESO/CAJA	PESO/PLT
22,5 x 33	8,8" x 13"	11	0,82	68	23,80	1.640
22,5 x 22,5	8,8" x 8,8"	17	0,86	60	23,19	1.406
11 x 22,5	4,3" x 8,8"	20	0,5	112	13,70	1.550

TECH·LAND

fine **RESISTANCE**
EVOLUTION
 EXTRUDED PORCELAIN TILE
CLASE III-R11
CLASS I R11
SOFT
CLASS I R11

in & out
 INTERIOR - EXTERIOR
ANTI-BACTERIAL



- GRES EXTR. PORCELÁNICO**
PORCELAIN EXTRUDED TILE
- SUPERFICIE MATE**
MATT SURFACE
- PAV. DE INTERIOR**
INDOOR FLOOR TILE
- SIN MANTENIMIENTO**
NO MAINTENANCE
- PAVIMENTO DE EXTERIOR**
OUTDOOR FLOOR TILE
- DESTONIFICADO ARMONIOSO**
CONTROLLED DESTONIFICATION
- RESIST. A LA HELADA**
FROST PROOF
- RESIST. A ÁCIDOS Y BASES**
RESIST. TO ACIDS & BASES

- FUERZA DE ROTURA**
3119 Nw
- CARGA DE ROTURA**
3408 Nw
- RESISTE LA FLEXIÓN**
28 N/mm2
- RESISTE EL DESGASTE**
PEI (II-III)
- RESISTE EL RAYADO**
MOHS - 8
- ANTIDESLIZANTE**
Clase III - R11
- ANTID. DCOF.**
0,69
- ANTID. DIN 51097**
Clase C > 37°
- MANCHAS**
Class 5 - Class A
- ABSORCIÓN**
0,3%
- DILATACIÓN**
6,6° 10° / °C
- ANTIBACTERIANO**
Norma JIS Z 2801

FORMATOS
 11 x 22,5 - 4,3" x 8,8"
 22,5 x 22,5 - 8,8" x 8,8"
 22,5 x 33 - 8,8" x 13"
 30 x 30 - 11,8" x 11,8"
 HEX. 18 x 20,5 - 7" x 8"



TECH LAND BASALT



DECORACIÓN · DECORATION

Decoración serie **TECH LAND** completa en pág. 88-89
 Complete TECH LAND decor on pág. 88-89

22,5 x 22,5 (G 56) 8,8" x 8,8" **m²**

Escala reducida



18 x 20,5 (G 27) 7" x 8" **m²**

Escala reducida



PIEZAS ESPECIALES · SPECIAL PIECES

Disponible en todos los colores · Available in all colors

Información ampliada en el catálogo "NATURPOOL"

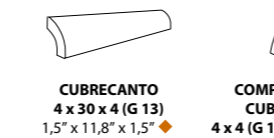
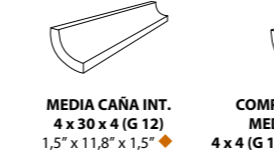
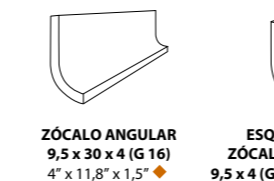
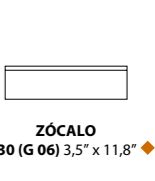
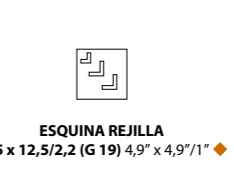
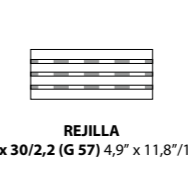
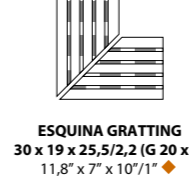
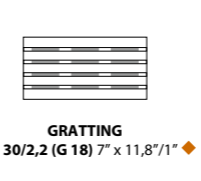
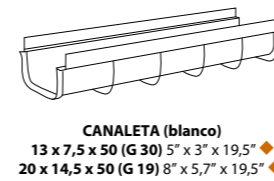
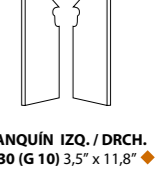
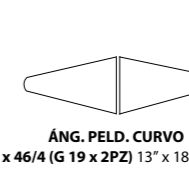
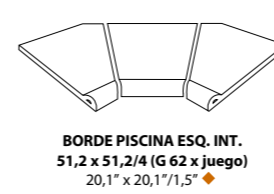

PACKING BASES

FORMATO	PULGADAS	PZ/CAJA	M²	CAJA/PLT	PESO/CAJA	PESO/PLT
HEX. 18 x 20,5	7" x 8"	30	0,83	48	22,57	1.098
11 x 22,5	4,3" x 8,8"	20	0,5	112	13,70	1.550
22,5 x 22,5	8,8" x 8,8"	17	0,86	60	23,19	1.406

PACKING BASES

FORMATO	PULGADAS	PZ/CAJA	M²	CAJA/PLT	PESO/CAJA	PESO/PLT
22,5 x 33	8,8" x 13"	11	0,82	68	23,80	1.640
30 x 30	11,8" x 11,8"	10	0,90	60	25	1.520

D'Anticatto

EXTERIOR



fine **RESISTANCE**
R11 - Class III

EXTERIOR CLASS III
UNE. 41901:2017 EXT



GRES EXTRUSIONADO PORCELÁNICO / PORCELAIN EXTRUDED TILE
 SUPERFICIE MATE / MATT SURFACE
 PAV. DE INTERIOR / INDOOR FLOOR TILE
 PAV. DE EXTERIOR / OUTDOOR FLOOR TILE
 SIN MANTENIMIENTO / NO MAINTENANCE
 RES. A ÁCIDOS Y BASES / RES. TO ACIDS AND BASES
 RES. A LA HELADA / FROST PROOF
 DESTONIFICADO ARMONIOSO / CONTROLLED DESTONIFICATION

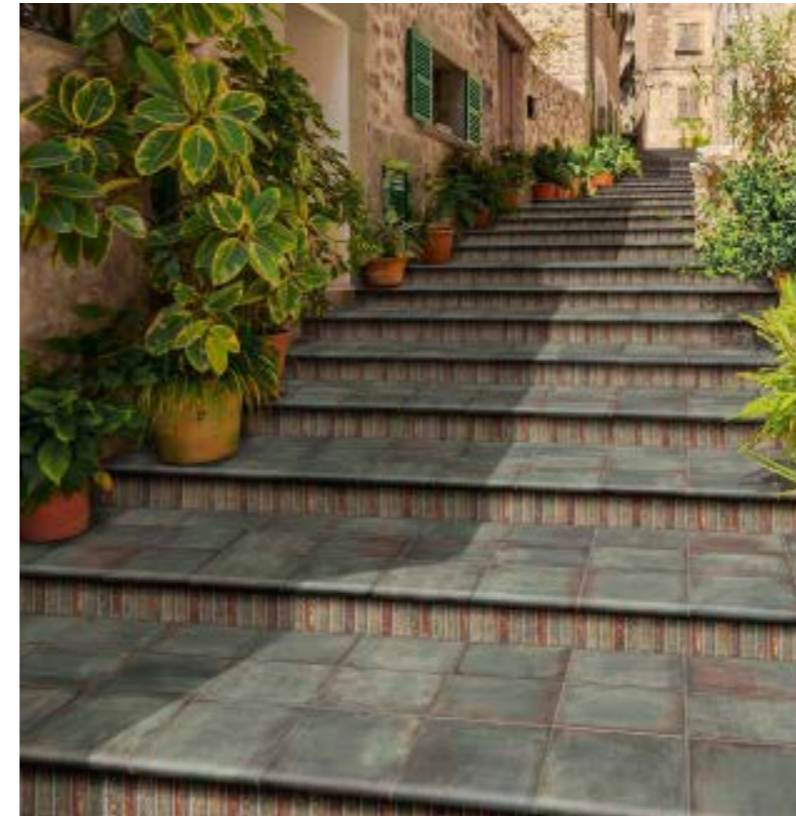

COLORES · COLORS

fine **RESISTANCE** ▶ R11 - Class III

 D'ANTICATTO BIANCO 11 x 22,5 (G 57) 4,3" x 8,8"	 D'ANTICATTO MARRONE 11 x 22,5 (G 57) 4,3" x 8,8"	 D'ANTICATTO GRIGIO 11 x 22,5 (G 57) 4,3" x 8,8"	 D'ANTICATTO AZURRO 11 x 22,5 (G 57) 4,3" x 8,8"	 D'ANTICATTO MUSCHIO 11 x 22,5 (G 57) 4,3" x 8,8"	 D'ANTICATTO NOTTE 11 x 22,5 (G 57) 4,3" x 8,8"
 D'ANTICATTO BIANCO 22,5 x 22,5 (G 25) 8,8" x 8,8"	 D'ANTICATTO MARRONE 22,5 x 22,5 (G 25) 8,8" x 8,8"	 D'ANTICATTO GRIGIO 22,5 x 22,5 (G 25) 8,8" x 8,8"	 D'ANTICATTO AZURRO 22,5 x 22,5 (G 25) 8,8" x 8,8"	 D'ANTICATTO MUSCHIO 22,5 x 22,5 (G 25) 8,8" x 8,8"	 D'ANTICATTO NOTTE 22,5 x 22,5 (G 25) 8,8" x 8,8"
 D'ANTICATTO BIANCO 22,5 x 45 (G 25) 8,8" x 17,7"	 D'ANTICATTO MARRONE 22,5 x 45 (G 25) 8,8" x 17,7"	 D'ANTICATTO GRIGIO 22,5 x 45 (G 25) 8,8" x 17,7"	 D'ANTICATTO AZURRO 22,5 x 45 (G 25) 8,8" x 17,7"	 D'ANTICATTO MUSCHIO 22,5 x 45 (G 25) 8,8" x 17,7"	 D'ANTICATTO NOTTE 22,5 x 45 (G 25) 8,8" x 17,7"

DECORACIÓN · DECORATION Decoración serie D'ANTICATTO completa en pág. 66-69 · Complete D'ANTICATTO decor on pág. 66-69

 MIX VARESE	 FLORENCE	 VARENNA	 LATERZA	 TRIANGOLI	 OBLIQUA	 QUADRATI
-----------------------	---------------------	--------------------	--------------------	----------------------	--------------------	---------------------

PIEZAS ESPECIALES · SPECIAL PIECES
Disponibles en todos los colores · Available in all colors

 ZÓCALO 9 x 30 (G 06) 3,5" x 11,8"	 ZANQUÍN IZO./DRCH. 9 x 30 (G 10) 3,5" x 11,8"
 ÁNG. PELD. CURVO 33 x 46/4 (G 19 x 2P2) 13" x 18"/1,5"	 PELDAÑO CURVO 22,5 x 33/4 (G 16) 8,8" x 13"/1,5"

PIEZAS ESPECIALES · SPECIAL PIECES
Disponibles en BIANCO y AZURRO · Available in BIANCO & AZURRO

 COMP. INT. MEDIA CAÑA 4 x 4 (G 17) 1,5" x 1,5"	 MEDIA CAÑA INT. 4 x 30 x 4 (G 12) 1,5" x 11,8" x 1,5"	 COMP. EXT. MEDIA CAÑA 4 x 4 (G 17) 1,5" x 1,5"
 COMP. EXT. CUBRECANTO 4 x 4 (G 17) 1,5" x 1,5"	 CUBRECANTO 4 x 30 x 4 (G 13) 1,5" x 11,8" x 1,5"	 COMP. INT. CUBRECANTO 4 x 4 (G 17) 1,5" x 1,5"

PACKING BASES

FORMATO	PULGADAS	PZ/CAJA	M²	CAJA/PLT	PESO/CAJA	PESO/PLT
22,5 x 45	8,8" x 17,7"	10	1,01	72	21,1	1.530
22,5 x 22,5	8,8" x 8,8"	20	1,01	72	20,7	1.505
11 x 22,5	4,3" x 8,8"	20	0,5	128	10,5	1.359

PACKING PIEZAS ESPECIALES

FORMATO	PULGADAS	PZ/CAJA	ML	CAJA/PLT	PESO/CAJA	PESO/PLT
PELDAÑO CUR. 22,5 x 33/4	8,8" x 13"/1,5"	6	13,5	64	12	783
ÁNG. PELD. CUR. 33 x 46/4	13" x 18"/1,5"	2	0,33	90	3,46	325

PACKING PIEZAS ESPECIALES

FORMATO	PULGADAS	PZ/CAJA	ML	CAJA/PLT	PESO/CAJA	PESO/PLT
ZÓCALO 9 x 30	3,5" x 11,8"	30	9	56	19,6	1.112
ZANQUÍN 9 x 30	3,5" x 11,8"	30	9	56	16,24	924
REMATE PELDAÑO 2,5 x 32	1" x 12,5"	20	6,4	60	3,4	219
MEDIA CAÑA INT. 4 x 30 x 4	1,5" x 11,8" x 1,5"	22	6,6		9,91	
COMP. EXT. M. CAÑA 4 x 4	1,5" x 1,5"	18	0,6		1,34	

PACKING PIEZAS ESPECIALES

FORMATO	PULGADAS	PZ/CAJA	ML	CAJA/PLT	PESO/CAJA	PESO/PLT
COMP. INT. M. CAÑA 4 x 4	1,5" x 1,5"	20	0,66		1,84	
CUBRECANTO 4 x 30 x 4	1,5" x 11,8" x 1,5"	26	7,8		7,33	
COMP. EXT. CUBREC. 4 x 4	1,5" x 1,5"	25	0,83		0,55	
COMP. INT. CUBREC. 4 x 4	1,5" x 1,5"	10	0,33		0,85	

D'Anticatto

INTERIOR



GRES EXTRUSIONADO PORCELÁNICO / PORCELAIN EXTRUDED TILE
 SUPERFICIE MATE / MATT SURFACE
 PAVIMENTO DE INTERIOR / INDOOR FLOOR TILE
 SIN MANTENIMIENTO / NO MAINTENANCE
 RES. A ÁCIDOS Y BASES / RES. TO ACIDS AND BASES
 RESISTENCIA A LA HELADA / FROST PROOF
 DESTONIFICADO ARMONIOSO / CONTROLLED DESTONIFICATION



COLORES · COLORS



D'ANTICATTO BIANCO
CHEVRON DCHA. / IZQ.
14 x 32,5 (G 39) 6" x 12,7"



D'ANTICATTO MARRONE
CHEVRON DCHA. / IZQ.
14 x 32,5 (G 39) 6" x 12,7"



D'ANTICATTO GRIGIO
CHEVRON DCHA. / IZQ.
14 x 32,5 (G 39) 6" x 12,7"



D'ANTICATTO AZURRO
CHEVRON DCHA. / IZQ.
14 x 32,5 (G 39) 6" x 12,7"



D'ANTICATTO MUSCHIO
CHEVRON DCHA. / IZQ.
14 x 32,5 (G 39) 6" x 12,7"



D'ANTICATTO NOTTE
CHEVRON DCHA. / IZQ.
14 x 32,5 (G 39) 6" x 12,7"

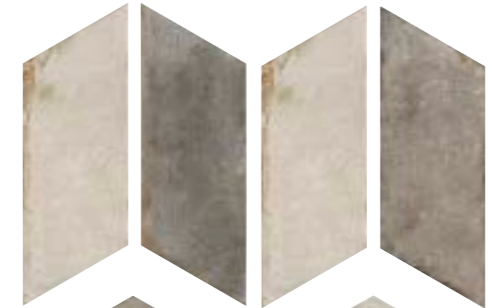

D'ANTICATTO MIX
CHEVRON DCHA. / IZQ.
14 x 32,5 (G 39) 6" x 12,7"
Se suministra mezclado por
BIANCO · GRIGIO · NOTTE



D'ANTICATTO BIANCO
HEX. 28,5 x 32,5 (G 56)
11,2" x 12,7"



D'ANTICATTO MARRONE
HEX. 28,5 x 32,5 (G 56)
11,2" x 12,7"



D'ANTICATTO GRIGIO
HEX. 28,5 x 32,5 (G 56)
11,2" x 12,7"



D'ANTICATTO AZURRO
HEX. 28,5 x 32,5 (G 56)
11,2" x 12,7"

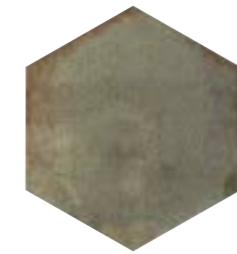

D'ANTICATTO MUSCHIO
HEX. 28,5 x 32,5 (G 56)
11,2" x 12,7"

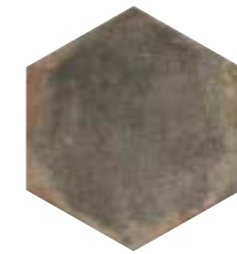

D'ANTICATTO NOTTE
HEX. 28,5 x 32,5 (G 56)
11,2" x 12,7"

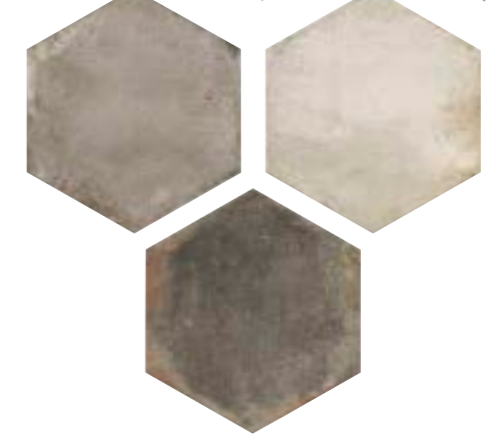

D'ANTICATTO MIX
HEX. 28,5 x 32,5 (G 39)
11,2" x 12,7"
Se suministra mezclado por
BIANCO · GRIGIO · NOTTE



D'ANTICATTO BIANCO
7 x 45 (G 27) 3" x 17,7"



D'ANTICATTO MARRONE
7 x 45 (G 27) 3" x 17,7"



D'ANTICATTO GRIGIO
7 x 45 (G 27) 3" x 17,7"



D'ANTICATTO AZURRO
7 x 45 (G 27) 3" x 17,7"



D'ANTICATTO MUSCHIO
7 x 45 (G 27) 3" x 17,7"

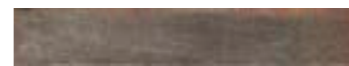

D'ANTICATTO NOTTE
7 x 45 (G 27) 3" x 17,7"



D'ANTICATTO MIX
7 x 45 (G 27) 3" x 17,7"
Se suministra mezclado por
BIANCO · GRIGIO · NOTTE

PACKING BASES

FORMATO	PULGADAS	PZ/CAJA	M²	CAJA/PLT	PESO/CAJA	PESO/PLT
HEX. 28,5 x 32,5	11,2" x 12,7"	15	1,05	48	21,9	1.063
CHEVRON 14 x 32,5	6" x 12,7"	21	0,96	72	21,46	1.560
7 x 45	3" x 17,7"	32	1	60	21,40	1.300

PACKING PIEZAS ESPECIALES

FORMATO	PULGADAS	PZ/CAJA	ML	CAJA/PLT	PESO/CAJA	PESO/PLT
ZÓCALO 9 x 30	3,5" x 11,8"	30	9	56	19,7	1112
ZANQUÍN 9 x 30	3,5" x 11,8"	30	9	56	16,24	924

FERRO di BOSTON



fine RESISTANCE

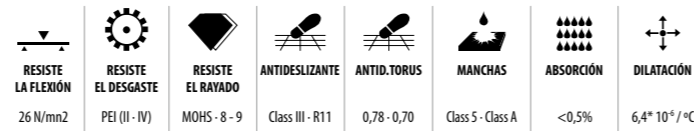

FERRO DI BOSTON BIANCO



FERRO DI BOSTON CREMA

COLORES · COLORS



FERRO DI BOSTON BIANCO
15 x 30 (G 25) 5,9" x 11,8" m



FERRO DI BOSTON CREMA
15 x 30 (G 25) 5,9" x 11,8" m



FERRO DI BOSTON ROSSO
15 x 30 (G 25) 5,9" x 11,8" m



FERRO DI BOSTON OMBRA
15 x 30 (G 25) 5,9" x 11,8" m



FERRO DI BOSTON BIANCO
HEX. 36 x 41,5 (G 58) 14" x 16,2" m

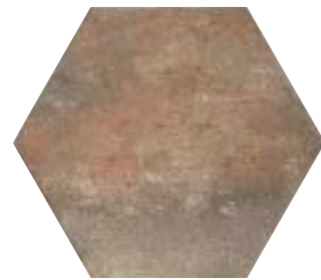

FERRO DI BOSTON CREMA
HEX. 36 x 41,5 (G 58) 14" x 16,2" m



FERRO DI BOSTON ROSSO
HEX. 36 x 41,5 (G 58) 14" x 16,2" m



FERRO DI BOSTON OMBRA
HEX. 36 x 41,5 (G 58) 14" x 16,2" m



FERRO DI BOSTON BIANCO
NAVETA 18,5 x 42 (G 39) 7" x 16,4" m



FERRO DI BOSTON CREMA
NAVETA 18,5 x 42 (G 39) 7" x 16,4" m



FERRO DI BOSTON ROSSO
NAVETA 18,5 x 42 (G 39) 7" x 16,4" m



FERRO DI BOSTON OMBRA
NAVETA 18,5 x 42 (G 39) 7" x 16,4" m



FERRO DI BOSTON BIANCO
36 x 36 (G 57) 14" x 14" m



FERRO DI BOSTON CREMA
36 x 36 (G 57) 14" x 14" m



FERRO DI BOSTON ROSSO
36 x 36 (G 57) 14" x 14" m



FERRO DI BOSTON OMBRA
36 x 36 (G 57) 14" x 14" m

PIEZAS ESPECIALES · SPECIAL PIECES

Disponible en todos los colores · Available in all colors

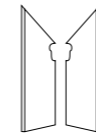

ZANQUÍN IZQ. / DRCH.
9 x 36 (G 10PZ) 3,5" x 14" m

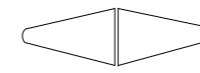

ÁNG. PELD. CURVO
33 x 46/4 (G 19 x 2PZ) 13" x 18"/1,5" m

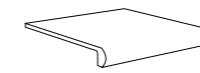

PELDAÑO CURVO
36 x 33/4 (G 18) 14" x 13"/1,5" m

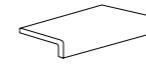

VIERTEAGUAS
15 x 30/4 (G 12) 5,9" x 11,8"/1,5" m

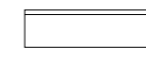

ZÓCALO
9 x 36 (G 07) 3,5" x 14" m



FERRO DI BOSTON ROSSO



FERRO DI BOSTON OMBRA

PACKING PIEZAS ESPECIALES

FORMATO	PULGADAS	PZ/CAJA	ML	CAJA/PLT	PESO/CAJA	PESO/PLT
ÁNG. PELD. CUR.	33 x 46/4	2	0,33	90	3,46	325
PELDAÑO CUR.	36 x 33/4	4	1,44	54	13,36	736
VIERTEAGUAS	15 x 30/4	14	4,20	36	20,54	760
ZÓCALO	9 x 36	30	10,8	48	22,5	1.120
ZANQUÍN	9 x 36	30	10,8	48	19,60	960

PACKING BASES

FORMATO	PULGADAS	PZ/CAJA	M²	CAJA/PLT	PESO/CAJA	PESO/PLT
36 x 36	14" x 14"	8	1	48	20,6	1005
HEX. 36 x 41,5	14" x 16,2"	9	1	48	22,6	1.103
15 x 30	5,9" x 11,8"	22	1	52	21,12	1.119
NAVETA 18,5 x 42	7" x 16,4"	13	1,01	64	19,93	1.290



PIEZAS ESPECIALES - SPECIAL PIECES
 Disponible en todos los colores - Available in all colors

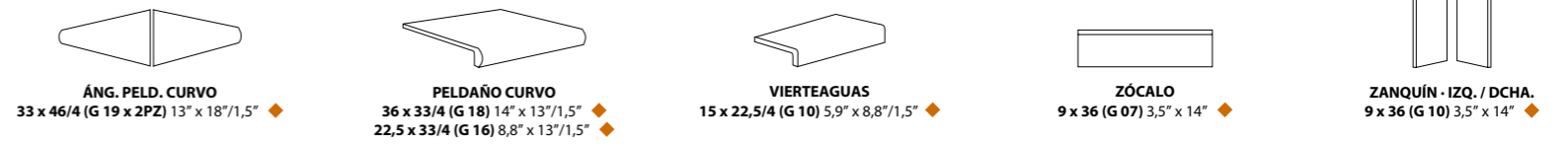

DECORACIÓN - DECORATION



FRONTAL COTTO
 15,5 x 30 (G 12) 6" x 11,8"

DECORACIÓN - DECORATION Decor AMERICAN completa en pág. 92-93 - Complete AMERICAN decor on pág. 92-93



MELROSE



NEWTON



CLEVELAND



HARVARD

COLORES - COLORS



BOSTON DOWNTOWN
 11 x 22,5 (G 57) 4,3" x 8,8"



BOSTON DOWNTOWN
 36 x 36 (G 57) 14" x 14"

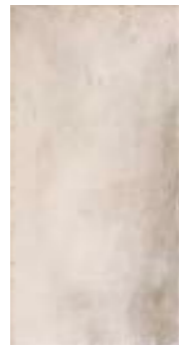

BOSTON DOWNTOWN
 22,5 x 45 (G 25) 8,8" x 17,7"



BOSTON DOWNTOWN
 HEX. 28,5 x 32,5 (G 39) 11,2" x 12,7"



BOSTON DOWNTOWN
 HEX. 36 x 41,5 (G 58) 14" x 16,2"



BOSTON SOUTH
 11 x 22,5 (G 57) 4,3" x 8,8"



BOSTON SOUTH
 36 x 36 (G 57) 14" x 14"



BOSTON SOUTH
 22,5 x 45 (G 25) 8,8" x 17,7"



BOSTON SOUTH
 HEX. 28,5 x 32,5 (G 39) 11,2" x 12,7"



BOSTON EAST
 11 x 22,5 (G 57) 4,3" x 8,8"



BOSTON EAST
 36 x 36 (G 57) 14" x 14"

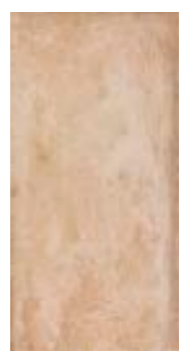

BOSTON EAST
 22,5 x 45 (G 25) 8,8" x 17,7"



BOSTON EAST
 HEX. 28,5 x 32,5 (G 39) 11,2" x 12,7"



BOSTON EAST
 HEX. 36 x 41,5 (G 58) 14" x 16,2"



BOSTON WEST
 11 x 22,5 (G 57) 4,3" x 8,8"



BOSTON WEST
 36 x 36 (G 57) 14" x 14"



BOSTON WEST
 22,5 x 45 (G 25) 8,8" x 17,7"



BOSTON WEST
 HEX. 28,5 x 32,5 (G 39) 11,2" x 12,7"



BOSTON WEST
 HEX. 36 x 41,5 (G 58) 14" x 16,2"



BOSTON NORTH
 11 x 22,5 (G 57) 4,3" x 8,8"



BOSTON NORTH
 36 x 36 (G 57) 14" x 14"



BOSTON NORTH
 22,5 x 45 (G 25) 8,8" x 17,7"



BOSTON NORTH
 HEX. 28,5 x 32,5 (G 39) 11,2" x 12,7"



BOSTON NORTH
 HEX. 36 x 41,5 (G 58) 14" x 16,2"

PACKING BASES

FORMATO	PULGADAS	PZ/CAJA	M ²	CAJA/PLT	PESO/CAJA	PESO/PLT
11 x 22,5	4,3" x 8,8"	20	0,5	128	10,5	1.359
22,5 x 22,5	8,8" x 8,8"	20	1,01	72	20,7	1.505
22,5 x 45	8,8" x 17,7"	10	1,01	72	21,1	1.530
36 x 36	14" x 14"	8	1	48	22,04	1.072
HEX. 28,5 x 32,5	11,2" x 12,7"	15	1,05	48	21,9	1.063
HEX. 36 x 41,5	14" x 16,2"	9	1	48	22,6	1.103

PACKING DECORADO

FORMATO	PULGADAS	PZ/CAJA	ML	CAJA/PLT	PESO/CAJA	PESO/PLT
15,5 x 30	6" x 11,8"	15	4,5	56	14,9	850

PACKING PIEZAS ESPECIALES

FORMATO	PULGADAS	PZ/CAJA	ML	CAJA/PLT	PESO/CAJA	PESO/PLT
ÁNG. PELD. CUR. 33 x 46/4	13" x 18" / 1,5"	2	0,33	90	3,46	325
PELDAÑO CUR. 36 x 33/4	14" x 13" / 1,5"	4	1,44	54	13,36	736
PELDAÑO CUR. 22,5 x 33/4	8,8" x 13" / 1,5"	6	1,35	64	12	783
VIERTEAGUAS 15 x 22,5/4	5,9" x 8,8" / 1,5"	14	3,15	48	15,08	739
ZÓCALO 9 x 36	3,5" x 14"	30	10,8	48	23,8	1.120
ZANQUÍN 9 x 36	3,5" x 14"	30	10,8	48	19,60	960

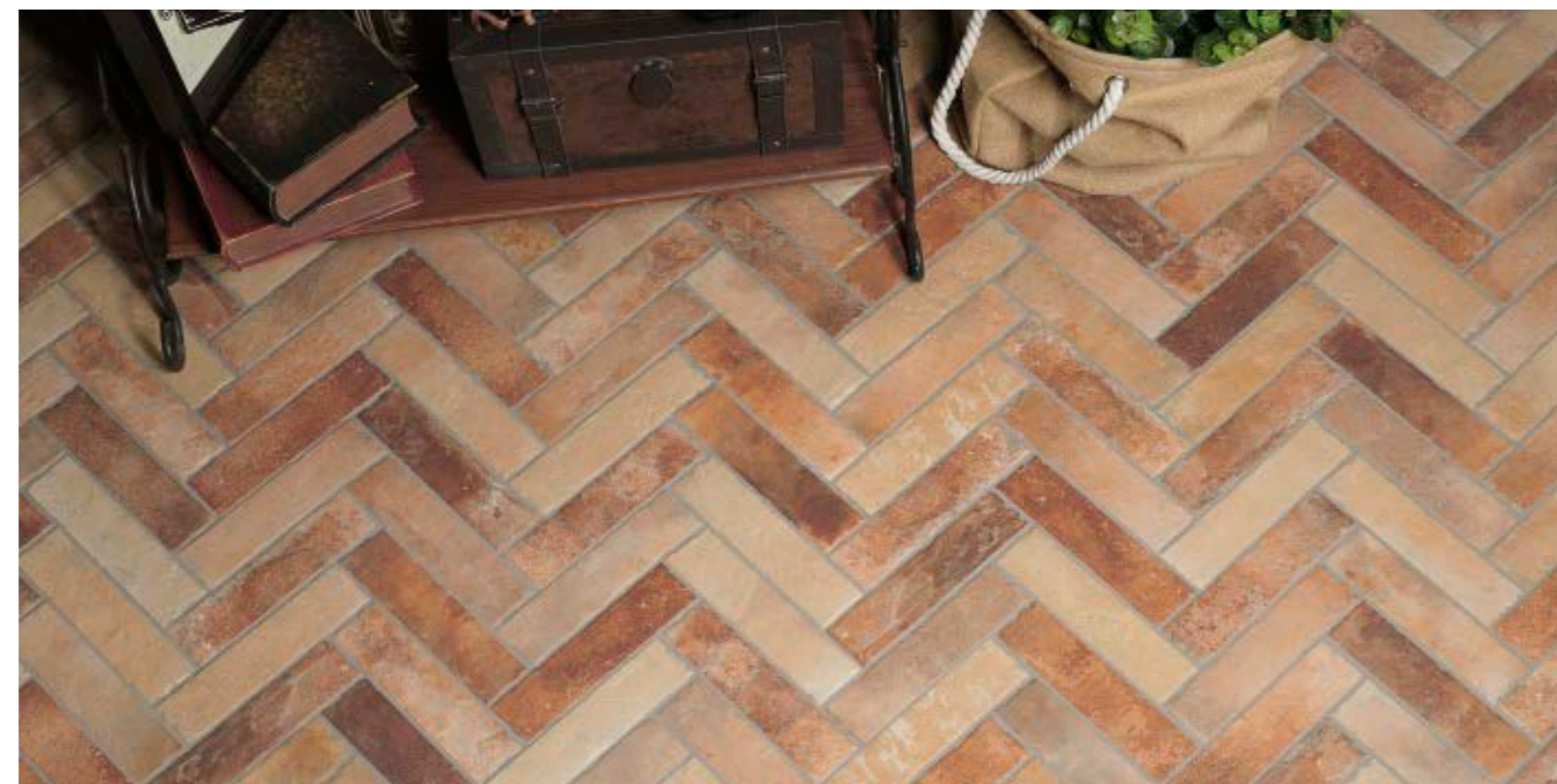

BRILLO - GLOSSY



BOSTON BRICK DAY TRAB. ENM.
25 x 50 (G 60) 10" x 20"



BOSTON BRICK DAY
6,5 x 25 (G 39) 2,5" x 10"



BOSTON BRICK NIGHT TRAB. ENM.
25 x 50 (G 60) 10" x 20"



BOSTON BRICK NIGHT
6,5 x 25 (G 39) 2,5" x 10"

MATE - MATT

fine **RESISTANCE** ▶ R12 - Class III



BOSTON BRICK DOWNTOWN TRAB. ENM.
25 x 50 (G 60) 10" x 20"



BOSTON BRICK DOWNTOWN
6,5 x 25 (G 39) 2,5" x 10"

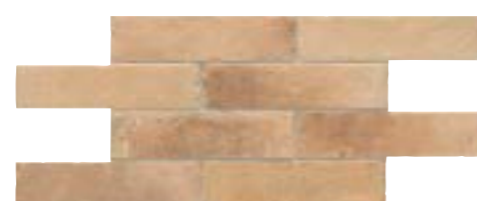

BOSTON BRICK EAST - NORTH TRAB. ENM.
25 x 50 (G 60) 10" x 20"



BOSTON BRICK EAST - NORTH
6,5 x 25 (G 39) 2,5" x 10"



BOSTON BRICK SOUTH TRAB. ENM.
25 x 50 (G 60) 10" x 20"



BOSTON BRICK SOUTH
6,5 x 25 (G 39) 2,5" x 10"

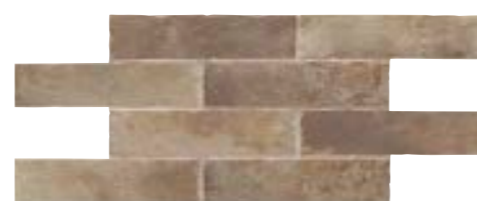

BOSTON BRICK WEST TRAB. ENM.
25 x 50 (G 60) 10" x 20"



BOSTON BRICK WEST
6,5 x 25 (G 39) 2,5" x 10"

PACKING BASES

FORMATO	PULGADAS	PZ/CAJA	M ²	CAJA/PLT	PESO/CAJA	PESO/PLT
6,5 x 25	2,5" x 10"	27	0,439	176	8,98	1.596
TRAB. 25 x 50	10" x 20"	6	0,75	40	15,90	651



COTTO NATURE



RESISTE LA FLEXIÓN 29 N/mn2	RESISTE EL DESGASTE PEI (III-IV)	RESISTE EL RAYADO MOHS - 8	ANTIDESLIZANTE CLASS III - R10	ANTID.TORUS 0,89 - 0,81	MANCHAS Class 5 - Class A	ABSORCIÓN 0,2%	DILATACIÓN 5,7* 10 ⁻⁴ /°C	fine RESISTANCE
29 N/mn2	PEI (III-IV)	MOHS - 6	CLASS I	-	Class 5 - Class A	0,2%	5,7* 10 ⁻⁴ /°C	Comfort floor
29 N/mn2	PEI (III-IV)	MOHS - 4	CLASS I	-	Class 5 - Class A	0,2%	5,7* 10 ⁻⁴ /°C	Comfort floor OLIO



COLORES · COLORS



PIEZAS ESPECIALES
SPECIAL PIECES
Disponibile en todos los colores
Available in all colors

SE FABRICAN EN CLASE I

Comfort floor

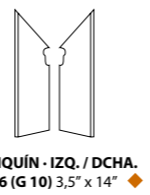
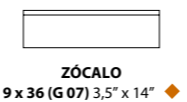

COLORES OLIO · COLORS OLIO



MODULACIÓN · MODULATION **DISPONIBLE EN CLASE I**

Comfort floor **SICILIA OLIO** · Comfort floor

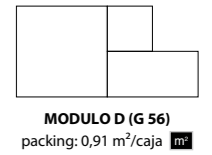
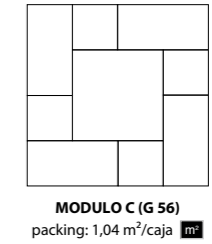

PIEZAS ESPECIALES · SPECIAL PIECES — Disponible en todos los colores
Available in all colors

Comfort floor **OLIO**

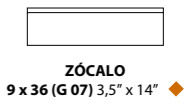

COLORES ANTIDESLIZANTE · COLORS ANTISLIP



PIEZAS ESPECIALES · SPECIAL PIECES **SE FABRICAN EN CLASE III - R10**
Disponibile en todos los colores
Available in all colors

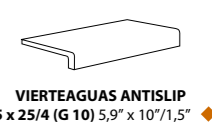
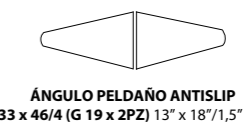
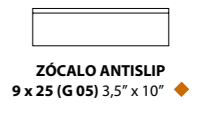
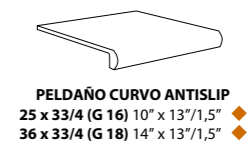

PACKING BASES

FORMATO	PULGADAS	PZ/CAJA	M ²	CAJA/PLT	PESO/CAJA	PESO/PLT
36 x 36	14" x 14"	8	1	48	22,04	1072
18 x 36	7" x 14"	16	1	72	23,33	1694
18 x 18	7" x 7"	30	0,97	72	21,4	1.555
25 x 25	10" x 10"	16	1	72	21,06	1.530
MODULO C	-	18	1,04	64	23	1.473
MODULO D	-	12	0,91	72	20	1.457

PACKING PIEZAS ESPECIALES

FORMATO	PULGADAS	PZ/CAJA	ML	CAJA/PLT	PESO/CAJA	PESO/PLT
LOSANGA 18 x 36	7" x 14"	16	5,76	72	22,82	1.657
ZÓCALO 9 x 36	3,5" x 14"	30	10,8	48	23,8	1.120
ZÓCALO 9 x 25	3,5" x 10"	40	10	60	24,1	1.461
PELD. CURVO 36 x 33/4	14" x 13"/1,5"	4	1,44	54	13,36	736
PELD. CURVO 25 x 33/4	10" x 13"/1,5"	6	1,5	54	13,48	743
ANG. PELD. 33 x 46/4	13" x 18"/1,5"	2	0,33	90	3,46	325
ZANQUÍN 9 x 36	3,5" x 14"	30	10,8	48	19,60	960
VIERTEAGUAS 15 x 25/4	5,9" x 10"/1,5"	14	3,5	48	16,9	831

29 N/mm2	PEI (III - IV)	MOHS-8	Class III - R10	0,83 - 0,76	Class 5 - Class A	0,1%	6,1° 10°/°C	fine RESISTANCE
29 N/mm2	PEI (III - IV)	MOHS-5	Class I	-	Class 5 - Class A	0,1%	6,1° 10°/°C	Confort floor



COLORES ANTIDESLIZANTE · COLORS ANTISLIP

fine RESISTANCE Antislip-R10 EXTERIOR CLASE III UNE. 41901:2007 EX

PORCELAIN EXTRUDED TILE	MATT SURFACE	OUTDOOR FLOOR TILE	INDOOR FLOOR TILE	NO MAINTENANCE	RES. TO ACIDS AND BASES	FROST PROOF	CONTROLLED DESTONIFICATION

TACO PIEMONTE ASTI
4 x 4 (G 01) 2" x 2" ◆



ESTRELLA PIEMONTE ASTI
15,5 x 15,5 (G 12) 6" x 6" ◆



LOSANGA PIEMONTE ASTI
15,5 x 36 (G 11) 6" x 14" ◆



PIEMONTE ASTI
36 x 36 (G 57) 14" x 14" m

TACO PIEMONTE NOVARA
4 x 4 (G 01) 2" x 2" ◆



ESTRELLA PIEMONTE NOVARA
15,5 x 15,5 (G 12) 6" x 6" ◆



LOSANGA PIEMONTE NOVARA
15,5 x 36 (G 11) 6" x 14" ◆



PIEMONTE NOVARA
36 x 36 (G 57) 14" x 14" m

TACO PIEMONTE TORINO
4 x 4 (G 01) 2" x 2" ◆



ESTRELLA PIEMONTE TORINO
15,5 x 15,5 (G 12) 6" x 6" ◆



LOSANGA PIEMONTE TORINO
15,5 x 36 (G 11) 6" x 14" ◆



PIEMONTE TORINO
36 x 36 (G 57) 14" x 14" m

PACKING BASES

FORMATO	PULGADAS	PZ/CAJA	M ²	CAJA/PLT	PESO/CAJA	PESO/PLT
36 x 36	14" x 14"	8	1	48	22,04	1072
18 x 36	7" x 14"	16	1	72	23,33	1694
18 x 18	7" x 7"	30	0,97	72	21,4	1.555
MODULO C	-	18	1,04	48	23	1.120
MODULO D	-	12	0,91	64	20	1.300

PACKING BASES

FORMATO	PULGADAS	PZ/CAJA	M ²	CAJA/PLT	PESO/CAJA	PESO/PLT
TACO 4,2 x 4,2	2" x 2"	50	2	112	2,1	-
TACO 4 x 4	2" x 2"	50	2	112	2,1	-

PIEZAS ESPECIALES · SPECIAL PIECES

Disponible en todos los colores
Available in all colors

SE FABRICA EN CLASE III - R10



PELDAÑO CURVO
36 x 33/4 (G 18) 14" x 13"/1,5" ◆



ÁNGULO PELDAÑO
33 x 46/4 (G 19 x 2PZ) 13" x 18"/1,5" ◆

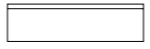

ZÓCALO
9 x 36 (G 07) 3,5" x 14" ◆

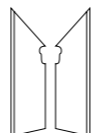

ZANQUÍN - IZO. / DCHA.
9 x 36 (G 10) 3,5" x 14" ◆

COLORES · COLORS

PORCELAIN EXTRUDED TILE	MATT SURFACE	INDOOR FLOOR TILE	NO MAINTENANCE	RES. TO ACIDS AND BASES	FROST PROOF	CONTROLLED DESTONIFICATION

PIEMONTE ALESSANDRIA
4,2 x 4,2 (G 01) 2" x 2" ◆



PIEMONTE ALESSANDRIA
18 x 18 (G 58) 7" x 7" m



PIEMONTE ALESSANDRIA
18 x 36 (G 57) 7" x 14" m



LOSANGA PIEMONTE ALESSANDRIA
18 x 36 (G 12) 7" x 14" ◆



PIEMONTE ALESSANDRIA
36 x 36 (G 57) 14" x 14" m

PIEMONTE BIELLA
4,2 x 4,2 (G 01) 2" x 2" ◆



PIEMONTE BIELLA
18 x 18 (G 58) 7" x 7" m



PIEMONTE BIELLA
18 x 36 (G 57) 7" x 14" m



LOSANGA PIEMONTE BIELLA
18 x 36 (G 12) 7" x 14" ◆



PIEMONTE BIELLA
36 x 36 (G 57) 14" x 14" m

PIEMONTE VERCELLI
4,2 x 4,2 (G 01) 2" x 2" ◆



PIEMONTE VERCELLI
18 x 18 (G 58) 7" x 7" m



PIEMONTE VERCELLI
18 x 36 (G 57) 7" x 14" m



LOSANGA PIEMONTE VERCELLI
18 x 36 (G 12) 7" x 14" ◆



PIEMONTE VERCELLI
36 x 36 (G 57) 14" x 14" m

MODULACIÓN · MODULATION

DISPONIBLE EN CLASE I · Confort floor

Escala a un 75% de la utilizada en este catálogo.

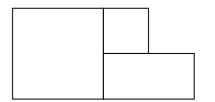

MODULO D (G 56)
packing: 0,91 m²/caja m

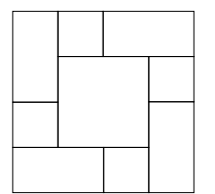

MODULO C (G 56)
packing: 1,04 m²/caja m

DECORACIÓN · DECORATION



ESTRELLA VERSILIA A
15,5 x 15,5 (G 31) 6" x 6" ◆
18 x 18 (G 18) 7" x 7" ◆



ESTRELLA VERSILIA B
15,5 x 15,5 (G 31) 6" x 6" ◆
18 x 18 (G 18) 7" x 7" ◆



ESTRELLA VERSILIA C
15,5 x 15,5 (G 31) 6" x 6" ◆
18 x 18 (G 18) 7" x 7" ◆



ESTRELLA VERSILIA D
15,5 x 15,5 (G 31) 6" x 6" ◆
18 x 18 (G 18) 7" x 7" ◆



FRONTAL VERSILIA
15,5 x 15,5 (G 17) 6" x 6" ◆

TACO VERSILIA
4 x 4 (G 04) 2" x 2" ◆

TACO VERSILIA
4,2 x 4,2 (G 04) 2" x 2" ◆



ESTRELLA VERSILIA A
36 x 36 (G 62) 14" x 14" ◆



ESTRELLA VERSILIA B
36 x 36 (G 62) 14" x 14" ◆



ESTRELLA VERSILIA C
36 x 36 (G 62) 14" x 14" ◆



ESTRELLA VERSILIA D
36 x 36 (G 62) 14" x 14" ◆



FRONTAL VERSILIA
15,5 x 36 (G 21) 6" x 14" ◆

TACO VERSILIA
8 x 8 (G 12) 3" x 3" ◆

TACO VERSILIA
8 x 8 (G 12) 3" x 3" ◆

TACO VERSILIA B
8 x 8 (G 12) 3" x 3" ◆

PACKING PIEZAS ESPECIALES

FORMATO	PULGADAS	PZ/CAJA	ML	CAJA/PLT	PESO/CAJA	PESO/PLT
LOSANGA 15,5 x 36	6" x 14"	12	4,32	60	15,22	928
LOSANGA 18 x 36	7" x 14"	16	5,76	72	22,82	1.657
ESTRELLA 15,5 x 15,5	6" x 6"	20	3,1	60	11,6	710
ZÓCALO 9 x 36	3,5" x 14"	30	10,8	48	23,8	1.120
ZANQUÍN 9 x 36	3,5" x 14"	30	10,8	48	19,60	960
PELD. CURVO 36 x 33/4	14" x 13"/1,5"	4	1,44	54	13,36	736
ANG. PELD. 33 x 46/4	13" x 18"/1,5"	2	0,33	90	3,46	325

PACKING DECORADO

FORMATO	PULGADAS	PZ/CAJA	ML	CAJA/PLT	PESO/CAJA
FRONTAL 15,5 x 36	6" x 14"	12	4,32	56	14,5
ESTRELLA 15,5 x 15,5	6" x 6"	16	2,73	56	10,35
ESTRELLA 18 x 18	7" x 7"	15	2,7	72	10,75
ESTRELLA 36 x 36	14" x 14"	8	2,88	40	22,5
TACO 8 x 8	3" x 3"	25	2	72	3,35
TACO 4 x 4 / 4,2 x 4,2	2" x 2"	50	2	60	2,1
TIRA 8 x 36	3" x 14"	15	5,4	72	9,1

Nobleza



FORMATOS
25 x 25 - 10" x 10"
30 x 30 - 11,8" x 11,8"

Terracota



FORMATOS
25 x 25 - 10" x 10"

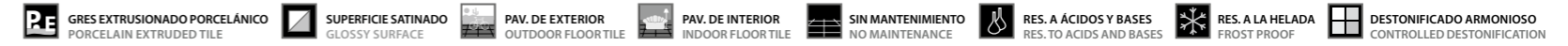

COLORES - COLORS

EXTERIOR ▶ R10 - Class II

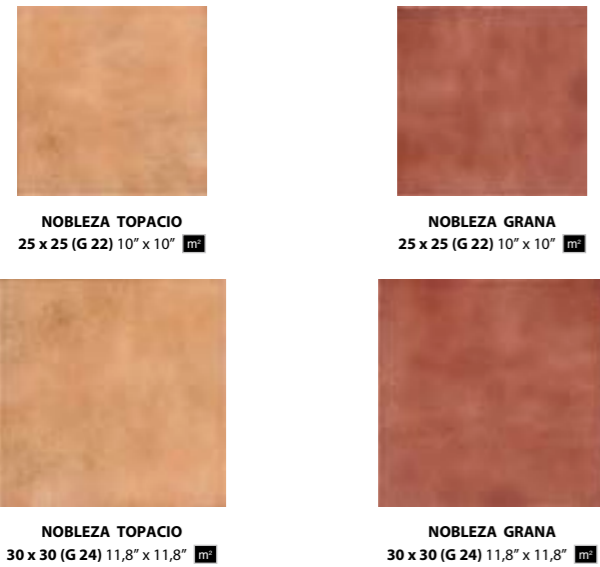

PIEZAS ESPECIALES - SPECIAL PIECES Disponible en todos los colores Available in all colors



COLORES - COLORS

Comfort floor ▶ Class I



PIEZAS ESPECIALES - SPECIAL PIECES Disponible en todos los colores Available in all colors

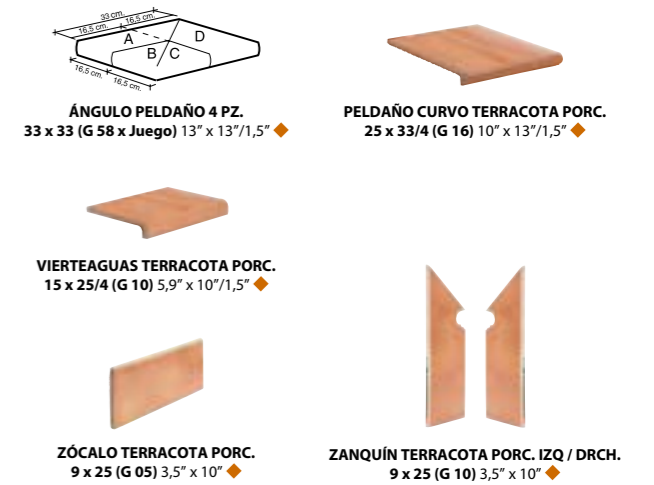

DECORACIÓN - DECORATION

3^{er} FUEGO



DECORACIÓN - DECORATION

3^{er} FUEGO

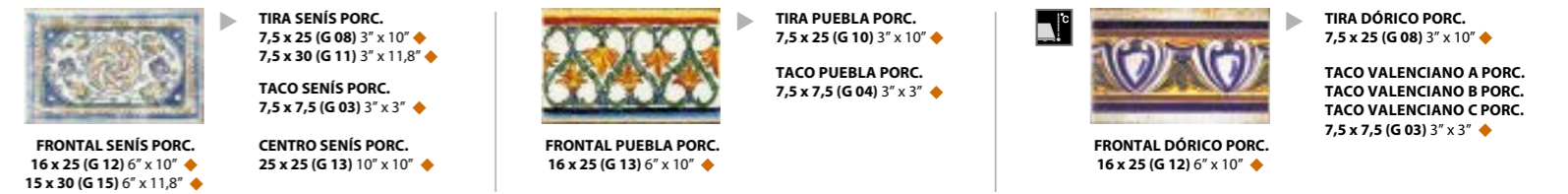

PACKING BASES

FORMATO	PULGADAS	PZ/CAJA	M ²	CAJA/PLT	PESO/CAJA	PESO/PLT
30 x 30	11,8" x 11,8"	11	1	72	20,27	1474
25 x 25	10" x 10"	16	1	72	21,06	1.530

PACKING PIEZAS ESPECIALES

FORMATO	PULGADAS	PZ/CAJA	ML	CAJA/PLT	PESO/CAJA	PESO/PLT
ANG. PELD. 33 x 46/4	13" x 18"/1,5"	2	0,33	90	3,45	324
PELD. CURVO 30 x 33/4	11,8" x 13"/1,5"	4	1,2	54	11,94	660
PELD. CURVO 25 x 33/4	10" x 13"/1,5"	6	1,5	54	13,48	743
VIERTEAGUAS 15 x 30/4	5,9" x 11,8"/1,5"	14	4,2	36	20,54	760
VIERTEAGUAS 15 x 25/4	5,9" x 10"/1,5"	14	3,5	48	16,9	831
ZÓCALO 9 x 30	3,5" x 11,8"	30	9	56	19,6	1.112
ZÓCALO 9 x 25	3,5" x 10"	40	10	60	24,1	1.461
ZANQUÍN 9 x 30	3,5" x 11,8"	30	9	56	16,24	924

PACKING DECORADOS

FORMATO	PULGADAS	PZ/CAJA	ML	CAJA/PLT	PESO/CAJA	PESO/PLT
FRONTAL 16 x 25	6" x 10"	20	5	48	16,3	797
TIRA 7,5 x 25	3" x 10"	50	12,5	48	20,1	979
TACO 7,5 x 7,5	3" x 3"	60	4,5	44	7,06	325
FRONTAL 15 x 30	6" x 11,8"	20	6	56	19,4	-
TIRA 7,5 x 30	3" x 11,8"	36	10,18	64	16,91	-
CENTRO 25 x 25	10" x 10"	16	4	72	21,06	-

PACKING PIEZAS ESPECIALES

FORMATO	PULGADAS	PZ/CAJA	ML	CAJA/PLT	PESO/CAJA	PESO/PLT
ANG. PELD. 33 x 33	13" x 13"/1,5"	1	0,33	90	3,98	373
PELD. CURVO 25 x 33/4	10" x 13"/1,5"	6	1,5	54	13,48	743
VIERTEAGUAS 15 x 25/4	5,9" x 10"/1,5"	14	3,5	48	16,9	831
ZÓCALO 9 x 25	3,5" x 10"	40	10	60	24,1	1.461
ZANQUÍN 9 x 25	3,5" x 10"	40	10	60	20,89	1.268

TECH·LAND DECOR

fine **RESISTANCE**
EVOLUTIV IN
 EXTRUDED PORCELAIN TILE
 CLASE III-R11
CLASS III-R11 SOFT

in & out
 INTERIOR - EXTERIOR
ANTI-BACTERIAL

14 mm
 ESPESOR
 THICKNESS

- PE** GRES EXTR. PORCELÁNICO
PORCELAIN EXTRUDED TILE
- SUPERFICIE MATE**
MATT SURFACE
- PAV. DE INTERIOR**
INDOOR FLOOR TILE
- SIN MANTENIMIENTO**
NO MAINTENANCE
- PAVIMENTO DE EXTERIOR**
OUTDOOR FLOOR TILE
- DESTONIFICADO ARMONIOSO**
CONTROLLED DESTONIFICATION
- RESIST. A LA HELADA**
FROST PROOF
- RESIST. A ÁCIDOS Y BASES**
RESIST. TO ACIDS & BASES

- FUERZA DE ROTURA**
3119 Nw
- CARGA DE ROTURA**
3408 Nw
- RESISTE LA FLEXIÓN**
28 N/mm2
- RESISTE EL DESGASTE**
PEI (II-III)
- RESISTE EL RAYADO**
MOHS - 8
- ANTIDESLIZANTE**
Clase III - R11
- ANTID. DCOF.**
0,69
- ANTID. DIN 51097**
Clase C > 37°
- MANCHAS**
Class 5 - Class A
- ABSORCIÓN**
0,3%
- DILATACIÓN**
6,6° 10° / °C
- ANTIBACTERIANO**
Norma JIS Z 2801



DECORACIÓN · DECORATION

La serie TECH LAND DECOR combina con las bases de la serie TECH LAND FIRE pág. 62
 TECH LAND DECOR combines with TECH LAND FIRE collection, pág. 62

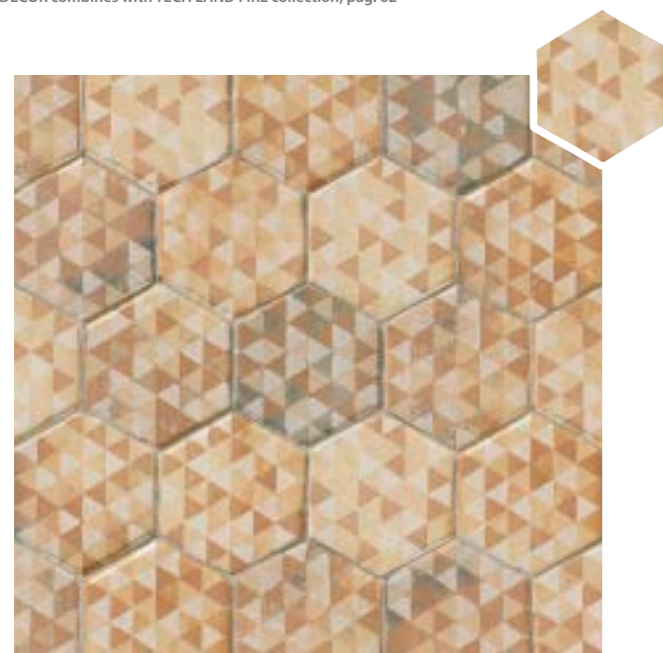

TECH LAND VINE FIRE
 18 x 20,5 (G 27) 7" x 8" **mm**

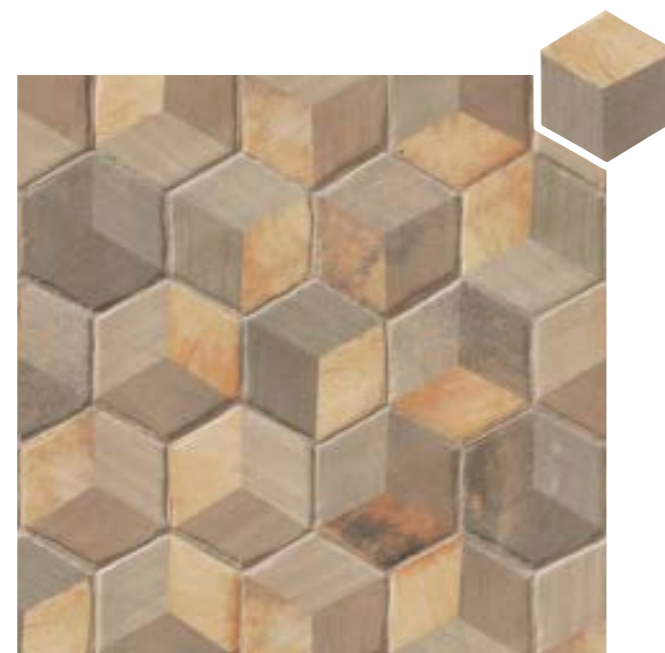

TECH LAND CUBIK FIRE
 18 x 20,5 (G 27) 7" x 8" **mm**



TECH LAND COAT FIRE
 22,5 x 22,5 (G 56) 8,8" x 8,8" **mm**



TECH LAND TEMPLE FIRE
 22,5 x 22,5 (G 56) 8,8" x 8,8" **mm**

PACKING DECOR

FORMATO	PULGADAS	PZ/CAJA	M ²	CAJA/PLT	PESO/CAJA	PESO/PLT
HEX 18 x 20,5	7" x 8"	30	0,83	48	22,57	1,098

PACKING DECOR

FORMATO	PULGADAS	PZ/CAJA	M ²	CAJA/PLT	PESO/CAJA	PESO/PLT
22,5 x 22,5	8,8" x 8,8"	17	0,86	60	23,19	1,406

DECORACIÓN · DECORATION



TECH LAND STAR FIRE
15,5 x 15,5 (G 52) 6" x 6" m



TECH LAND STAR TEMPLE FIRE
15,5 x 15,5 (G 52) 6" x 6" m



TECH LAND CROSS FIRE
15,5 x 15,5 (G 52) 6" x 6" m



TECH LAND CROSS TEMPLE FIRE
15,5 x 15,5 (G 52) 6" x 6" m



TECH LAND CROSS FIRE
15,5 x 15,5 (G 52) 6" x 6" m

TECH LAND STAR FIRE
15,5 x 15,5 (G 52) 6" x 6" m

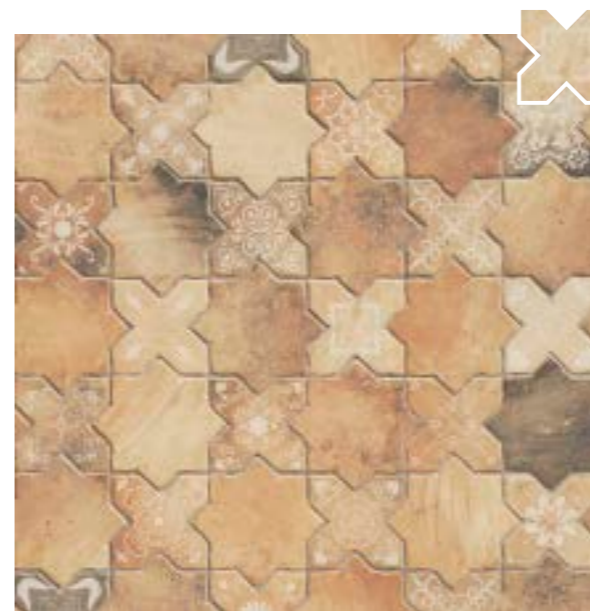

TECH LAND CROSS TEMPLE FIRE
15,5 x 15,5 (G 52) 6" x 6" m

TECH LAND STAR FIRE
15,5 x 15,5 (G 52) 6" x 6" m

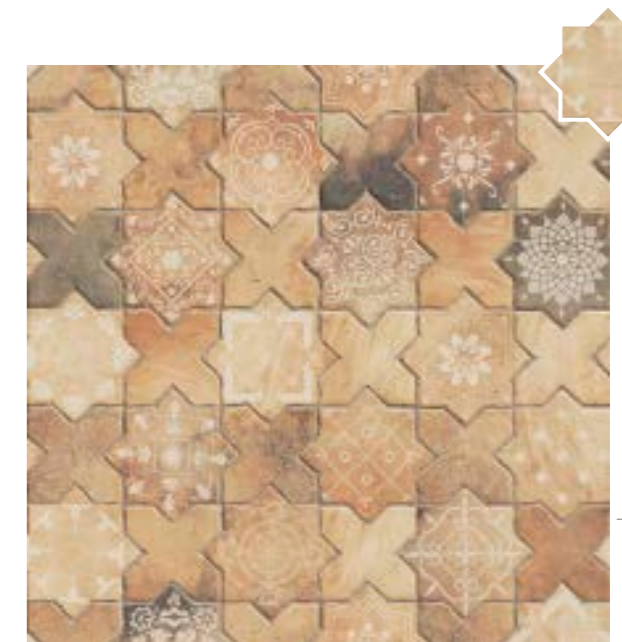

TECH LAND STAR TEMPLE FIRE
15,5 x 15,5 (G 52) 6" x 6" m

TECH LAND CROSS FIRE
15,5 x 15,5 (G 52) 6" x 6" m

DECORADOS · DECORATION



TACO SANDRO PORC.
6,5 x 6,5 (G 11) 3" x 3" ◆



TACO VERSILIA
4 x 4 (G 04) 2" x 2" ◆



TACO VOLTERRA
4 x 4 (G 04) 2" x 2" ◆



TECH LAND CROSS TEMPLE FIRE
15,5 x 15,5 (G 52) 6" x 6" m

TECH LAND STAR TEMPLE FIRE
15,5 x 15,5 (G 52) 6" x 6" m

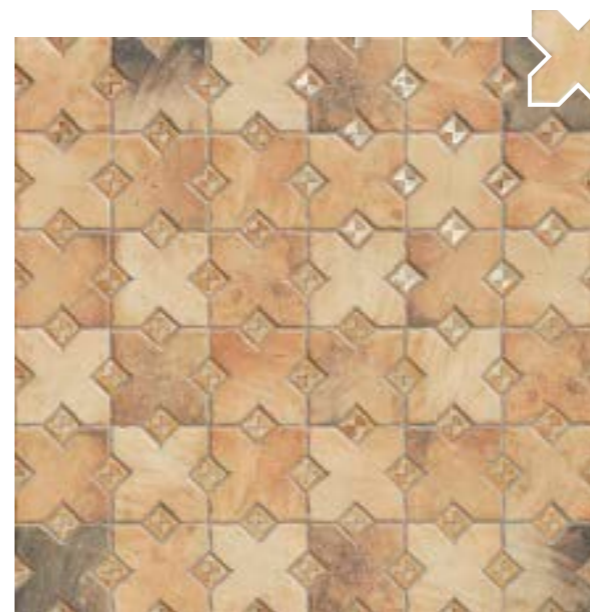

TECH LAND CROSS FIRE
15,5 x 15,5 (G 52) 6" x 6" m

TACO VOLTERRA
4 x 4 (G 04) 2" x 2" ◆

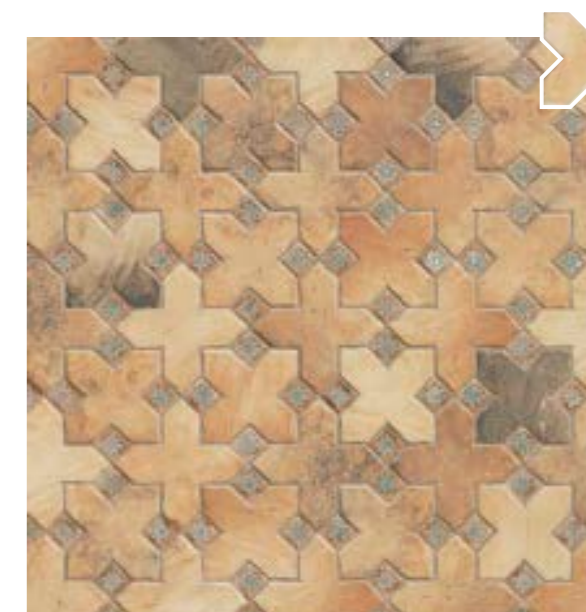

TECH LAND CROSS FIRE
15,5 x 15,5 (G 52) 6" x 6" m

TACO VERSILIA
4 x 4 (G 04) 2" x 2" ◆

PACKING DECOR

FORMATO	PULGADAS	PZ/CAJA	M²	CAJA/PLT	PESO/CAJA	PESO/PLT
STAR 15,5 x 15,5	6" x 6"	12	0,34	96	9,9	966
CROSS 15,5 x 15,5	6" x 6"	18	0,43	105	10,40	1.107

PACKING DECOR

FORMATO	PULGADAS	PZ/CAJA	M²	CAJA/PLT	PESO/CAJA	PESO/PLT
TACO 6,5 x 6,5	3" x 3"	60	3,9	60	5,02	-
TACO 4 x 4	2" x 2"	50	2	60	2,1	-

TECH·LAND DECOR

fine **RESISTANCE**

EVOLUTION
EXTRUDED PORCELAIN TILE

CLASE III-R11

in & out
INTERIOR - EXTERIOR

ANTI-BACTERIAL



PE GRES EXTR. PORCELÁNICO
PORCELAIN EXTRUDED TILE

SUPERFICIE MATE
MATT SURFACE

PAV. DE INTERIOR
INDOOR FLOOR TILE

SIN MANTENIMIENTO
NO MAINTENANCE

RESIST. A LA HELADA
FROST PROOF

PAVIMENTO DE EXTERIOR
OUTDOOR FLOOR TILE

DESTONIFICADO ARMONIOSO
CONTROLLED DESTONIFICATION

RESIST. A ÁCIDOS Y BASES
RESIST. TO ACIDS & BASES



FUERZA DE ROTURA
3119 Nw



CARGA DE ROTURA
3408 Nw



RESISTE LA FLEXIÓN
28 N/mm2



RESISTE EL DESGASTE
PEI (II-III)



RESISTE EL RAYADO
MOHS - 8



ANTIDESLIZANTE
Clase III - R11



ANTID. DCOF.
0,69



ANTID. DIN 51097
Clase C > 37°



MANCHAS
Class 5 - Class A



ABSORCIÓN
0,3%



DILATACIÓN
6,6° 10° / °C



ANTIBACTERIANO
Norma JIS Z 2801

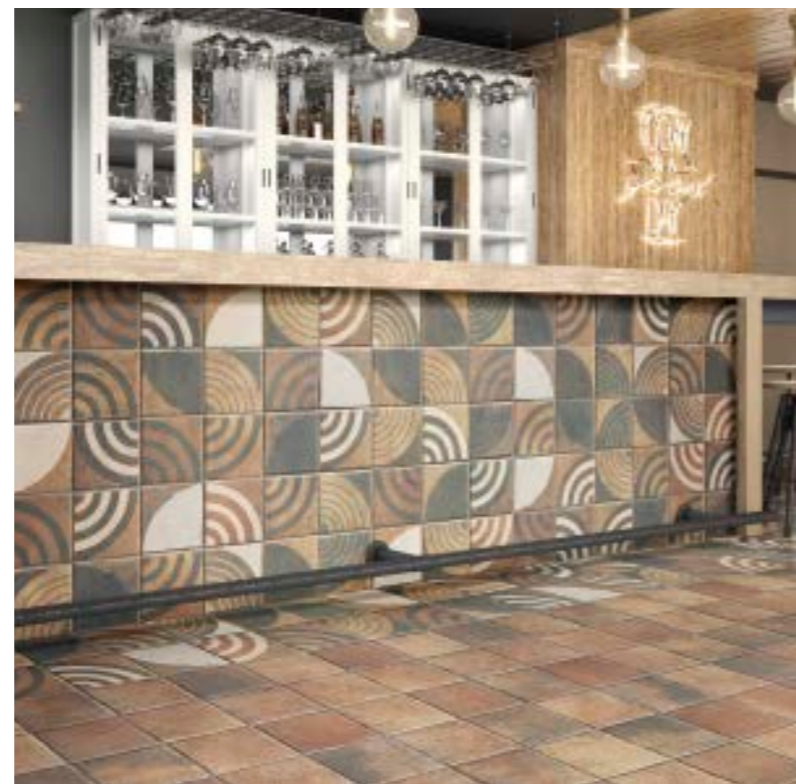

TECH LAND ASTRO TERRA
22,5 x 22,5 (G 56) 8,8" x 8,8" **m**



TECH LAND ASTRO DARK
22,5 x 22,5 (G 56) 8,8" x 8,8" **m**



TECH LAND TEMPLE NATURAL
22,5 x 22,5 (G 56) 8,8" x 8,8" **m**

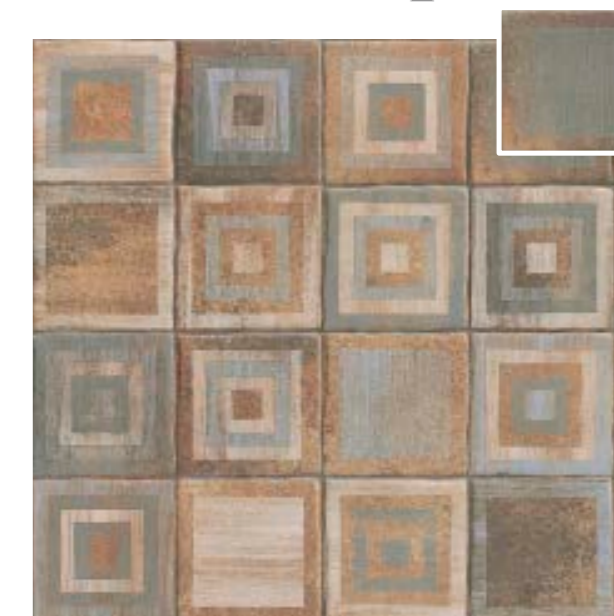

TECH LAND CRAYON SKY NATURAL
22,5 x 22,5 (G 56) 8,8" x 8,8" **m**

DECORACIÓN · DECORATION

La serie **TECH LAND DECOR** combina con las bases de la serie **TECH LAND NATURAL** pág. 63
TECH LAND DECOR combines with TECH LAND NATURAL collection, pág. 63



TECH LAND FIBBER NATURAL
18 x 20,5 (G 27) 7" x 8" **m**



TECH LAND CRAYON RED NATURAL
18 x 20,5 (G 27) 7" x 8" **m**



TECH LAND PLANET NATURAL
22,5 x 22,5 (G 56) 8,8" x 8,8" **m**

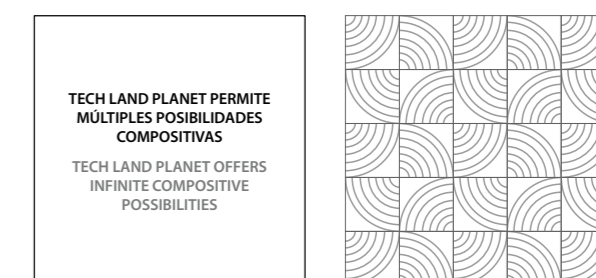

**TECH LAND PLANET PERMITE
MÚLTIPLES POSIBILIDADES
COMPOSITIVAS**
TECH LAND PLANET OFFERS
INFINITE COMPOSITIVE
POSSIBILITIES

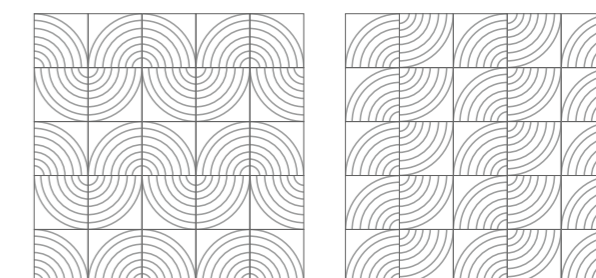

PACKING DECOR

FORMATO	PULGADAS	PZ/CAJA	M ²	CAJA/PLT	PESO/CAJA	PESO/PLT
HEX 18 x 20,5	7" x 8"	30	0,83	48	22,57	1.098

PACKING DECOR

FORMATO	PULGADAS	PZ/CAJA	M ²	CAJA/PLT	PESO/CAJA	PESO/PLT
22,5 x 22,5	8,8" x 8,8"	17	0,86	60	23,19	1.406

TECH·LAND DECOR

fine **RESISTANCE**

EVOLUTION
EXTRUDED PORCELAIN TILE

CLASE III-R11
CLASS III-R11

in & out
INTERIOR - EXTERIOR

ANTI-BACTERIAL



PE GRES EXTR. PORCELÁNICO
PORCELAIN EXTRUDED TILE

PAV. DE INTERIOR
INDOOR FLOOR TILE

PAVIMENTO DE EXTERIOR
OUTDOOR FLOOR TILE

SUPERFICIE MATE
MATT SURFACE

SIN MANTENIMIENTO
NO MAINTENANCE

DESTONIFICADO ARMONIOSO
CONTROLLED DESTONIFICATION

RESIST. A LA HELADA
FROST PROOF

RESIST. A ÁCIDOS Y BASES
RESIST. TO ACIDS & BASES



FUERZA DE ROTURA
3119 Nw



CARGA DE ROTURA
3408 Nw



RESISTE LA FLEXIÓN
28 N/mm2



RESISTE EL DESGASTE
PEI (II-III)



RESISTE EL RAYADO
MOHS - 8



ANTIDESLIZANTE
Clase III - R11



ANTID. DCOF.
0,69



ANTID. DIN 51097
Clase C > 37°



MANCHAS
Class 5 - Class A



ABSORCIÓN
0,3%



DILATACIÓN
6,6° 10° / °C



ANTIBACTERIANO
Norma JIS Z 2801



DECORACIÓN · DECORATION

La serie **TECH LAND DECOR** combina con las bases de la serie **TECH LAND BASALT** pág. 64
TECH LAND DECOR combines with TECH LAND BASALT collection, pág. 64



TECH LAND FIBBER BASALT
18 x 20,5 (G 27) 7" x 8" **mm**



TECH LAND CRAYON RED BASALT
18 x 20,5 (G 27) 7" x 8" **mm**



TECH LAND TEMPLE BASALT
22,5 x 22,5 (G 56) 8,8" x 8,8" **mm**



TECH LAND CRAYON SKY BASALT
22,5 x 22,5 (G 56) 8,8" x 8,8" **mm**



TECH LAND PLANET BASALT
22,5 x 22,5 (G 56) 8,8" x 8,8" **mm**

TECH LAND PLANET PERMITE MÚLTIPLES POSIBILIDADES COMPOSITIVAS
TECH LAND PLANET OFFERS INFINITE COMPOSITIVE POSSIBILITIES

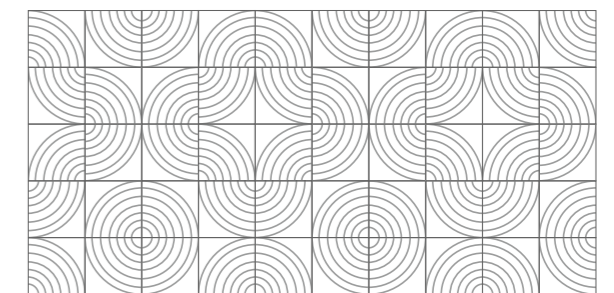

PACKING DECOR

FORMATO	PULGADAS	PZ/CAJA	M ²	CAJA/PLT	PESO/CAJA	PESO/PLT
HEX 18 x 20,5	7" x 8"	30	0,83	48	22,57	1,098

PACKING DECOR

FORMATO	PULGADAS	PZ/CAJA	M ²	CAJA/PLT	PESO/CAJA	PESO/PLT
22,5 x 22,5	8,8" x 8,8"	17	0,86	60	23,19	1,406



MIX VARESE
22,5 x 22,5 (G 57) 8,8" x 8,8" m

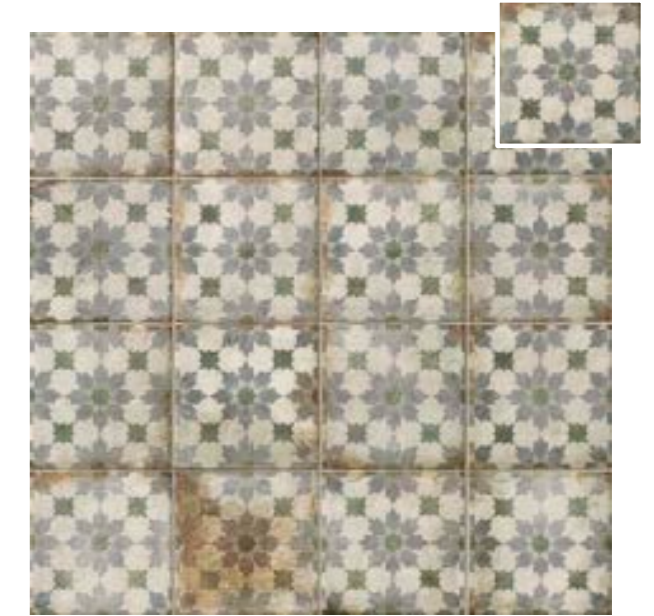

VARENNA
22,5 x 22,5 (G 57) 8,8" x 8,8" m



FLORENCE
22,5 x 22,5 (G 57) 8,8" x 8,8" m



LATERZA
22,5 x 22,5 (G 57) 8,8" x 8,8" m

DECORACIÓN · DECORATION

La serie D'ANTICATTO DECOR combina con las bases de la serie D'ANTICATTO pág. 66-69
D'ANTICATTO DECOR combines with D'ANTICATTO collection, pág. 66-69

fine RESISTANCE ▶ R11 - Class III



TRIANGOLI
22,5 x 22,5 (G 57) 8,8" x 8,8" m



QUADRATI
22,5 x 22,5 (G 57) 8,8" x 8,8" m



OBLIQUA
22,5 x 22,5 (G 57) 8,8" x 8,8" m

D'ANTICATTO OBLIQUA PERMITE
MÚLTIPLES POSIBILIDADES
COMPOSITIVAS
D'ANTICATTO OBLIQUA OFFERS
INFINITE COMPOSITE
POSSIBILITIES

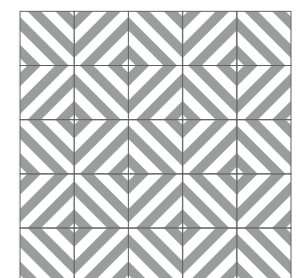
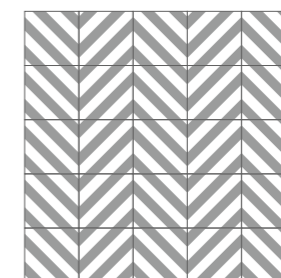
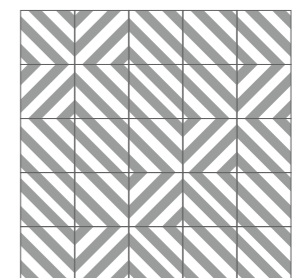

PACKING DECOR

FORMATO	PULGADAS	PZ/CAJA	M ²	CAJA/PLT	PESO/CAJA	PESO/PLT
22,5 x 22,5	8,8" x 8,8"	20	1,01	72	20,7	1,505



RESISTE LA FLEXIÓN 37 N/mm ²	RESISTE EL DESGASTE PEI (III - IV)	RESISTE EL RAYADO MOHS - 9	ANTIDESLIZANTE Class III - R12	ANTID.TORUS 0,82 - 0,76	MANCHAS Class 5 - Class A	ABSORCIÓN 0,1%	DILATACIÓN 6,4° 10° / °C
--	---------------------------------------	-------------------------------	-----------------------------------	----------------------------	------------------------------	-------------------	-----------------------------

GRÉS EXTRUDEDADO PORCELÁNICO PORCELAIN EXTRUDED TILE	SUPERFICIE MATE MATT SURFACE	PAV. DE INTERIOR INDOOR FLOOR TILE	PAV. DE EXTERIOR OUTDOOR FLOOR TILE	SIN MANTENIMIENTO NO MAINTENANCE	RES. A ÁCIDOS Y BASES RES. TO ACIDS AND BASES	RES. A LA HELADA FROST PROOF	DESTONIFICADO ARMONIOSO CONTROLLED DESTONIFICATION
---	---------------------------------	---------------------------------------	--	-------------------------------------	--	---------------------------------	---



DECORACIÓN · DECORATION

La serie AMERICAN combina con las bases de la serie BOSTON pág. 72-73
AMERICAN combines with BOSTON collection, pág. 72-73



AMERICAN MELROSE (MIX)
22,5 x 22,5 (G 57) 8,8" x 8,8" m



AMERICAN HARVARD (MIX)
22,5 x 22,5 (G 57) 8,8" x 8,8" m



AMERICAN NEWTON
22,5 x 22,5 (G 57) 8,8" x 8,8" m



AMERICAN CLEVELAND
22,5 x 22,5 (G 57) 8,8" x 8,8" m

PACKING DECOR

FORMATO	PULGADAS	PZ/CAJA	M ²	CAJA/PLT	PESO/CAJA	PESO/PLT
22,5 x 22,5	8,8" x 8,8"	20	1,01	72	20,7	1,505



DECORACIÓN · DECORATION

Comfort floor ▶ Class I

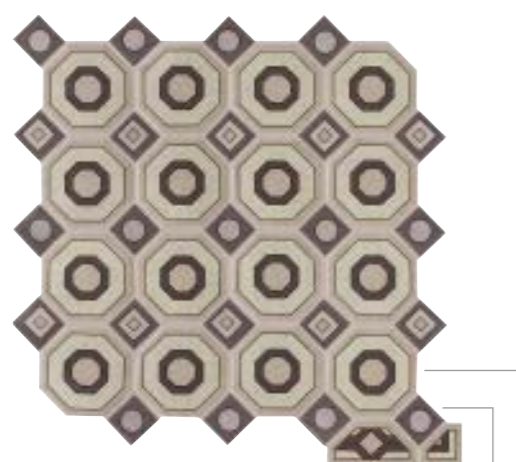

CEMENTI OTTO LIN

- ◆ CENEFA 6,1 x 12,2 (G 06) 2,8" x 4,8"
- ◆ ESQUINA 6,1 x 6,1 (G 06) 2,8" x 2,8"
- ◆ TACO 5 x 5 (G 02) 2" x 2"
- ◆ OCT. 12,2 x 12,2 (G 06) 4,8" x 4,8"
- ◆ ENM. (12,2 x 12,2) 37 x 37 (G 40) 14,5" x 14,5"



CEMENTI OTTO VIC

- ◆ TACO 5 x 5 (G 02) 2" x 2"
- ◆ OCT. 12,2 x 12,2 (G 06) 4,8" x 4,8"
- ◆ ENM. (12,2 x 12,2) 37 x 37 (G 40) 14,5" x 14,5"

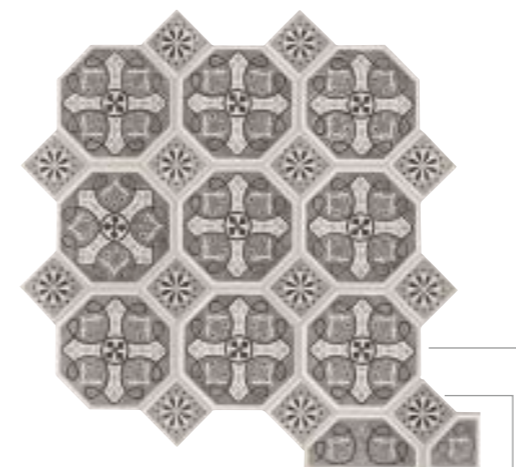

CEMENTI OTTO FLO

- ◆ CENEFA 8,5 x 17 (G 10) 3,3" x 6,6"
- ◆ ESQUINA 8,5 x 8,5 (G 10) 3,3" x 3,3"
- ◆ TACO 7 x 7 (G 02) 2,7" x 2,7"
- ◆ OCT. 17 x 17 (G 10) 6,6" x 6,6"
- ◆ ENM. (17 x 17) 34,5 x 34,5 (G 53) 13,5" x 13,5"



CEMENTI OTTO ALA BLU

- ◆ CENEFA 8,5 x 17 (G 10) 3,3" x 6,6"
- ◆ ESQUINA 8,5 x 8,5 (G 10) 3,3" x 3,3"
- ◆ TACO 7 x 7 (G 02) 2,7" x 2,7"
- ◆ OCT. 17 x 17 (G 10) 6,6" x 6,6"
- ◆ ENM. (17 x 17) 34,5 x 34,5 (G 53) 13,5" x 13,5"

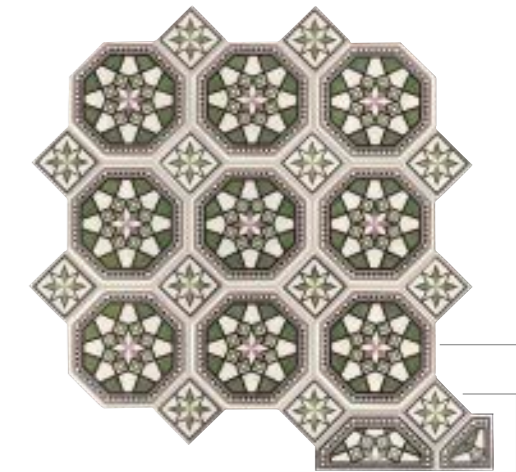

CEMENTI OTTO ALA VERDE

- ◆ CENEFA 8,5 x 17 (G 10) 3,3" x 6,6"
- ◆ ESQUINA 8,5 x 8,5 (G 10) 3,3" x 3,3"
- ◆ TACO 7 x 7 (G 02) 2,7" x 2,7"
- ◆ OCT. 17 x 17 (G 10) 6,6" x 6,6"
- ◆ ENM. (17 x 17) 34,5 x 34,5 (G 53) 13,5" x 13,5"



CEMENTI OTTO MED GRIS

- ◆ TACO GRIS 7 x 7 (G 02) 2,7" x 2,7"
- ◆ OCT. 17 x 17 (G 10) 6,6" x 6,6"
- ◆ ENM. (17 x 17) 34,5 x 34,5 (G 53) 13,5" x 13,5"

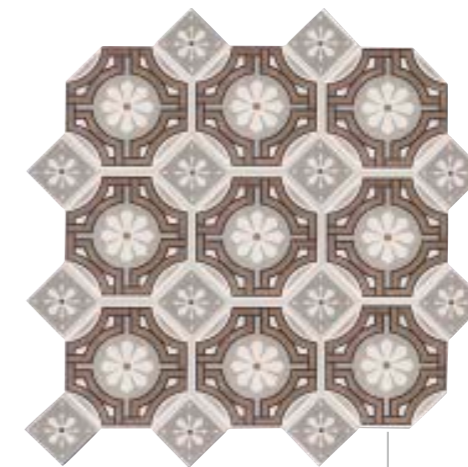

CEMENTI OTTO MED

- ◆ TACO GRIS 7 x 7 (G 02) 2,7" x 2,7"
- ◆ OCT. 17 x 17 (G 10) 6,6" x 6,6"
- ◆ ENM. (17 x 17) 34,5 x 34,5 (G 53) 13,5" x 13,5"

Composición por metro:

17 x 17 Cementi Oct. 35Pz · 7 x 7 Taco Cementi 35 Pz.
12,2 x 12,2 Cementi Oct. 68 Pz · 5 x 5 Taco Cementi 68 Pz.

PACKING

FORMATO	PULGADAS	PZ/CAJA	M ²	ML	CAJA/PLT	PESO/CAJA	PESO/PLT
17 x 17	6,6" x 6,6"	31	0,74	5,27	72	17,15	1.249
12,2 x 12,2	4,8" x 4,8"	42	0,525	5,12	60	12,90	790
CENEFA 8,5 x 17	3,3" x 6,6"	26	-	4,42	56	7,25	-
CENEFA 6,1 x 12,2	2,8" x 4,8"	36	-	1,28	56	5,50	-
ESQUINA 8,5 x 8,5	3,3" x 3,3"	15	-	1,28	56	2,17	-
ESQUINA 6,1 x 6,1	2,8" x 2,8"	20	-	4,39	56	1,70	-
TACO 7 x 7	2,7" x 2,7"	58	-	4,06	44	2,6	-
TACO 5 x 5	2" x 2"	90	-	4,5	60	2,08	-
ENM. (17x17) 34,5 x 34,5	13,5" x 13,5"	7	0,83	2,45	40	24,6	998
ENM. (12,2x12,2) 37 x 37	14,5" x 14,5"	7	0,96	2,59	56	21,8	1.235

MODELI

Comfort floor
EVOLUTION
EXTRUDED PORCELAIN TILE

RESISTE LA FLEXIÓN
30 N/mm2

ANTIDESLIZANTE
Class I

MANCHAS
Class 5 - Class A

ABSORCIÓN
0,2%

DILATACIÓN
6,6° 10° / °C

- GRES EXTRUSIONADO PORCELÁNICO
PORCELAIN EXTRUDED TILE
- SUPERFICIE SATINADO
GLOSSY SURFACE
- PAV. DE INTERIOR
INDOOR FLOOR TILE
- SIN MANTENIMIENTO
NO MAINTENANCE
- RES. A ÁCIDOS Y BASES
RES. TO ACIDS AND BASES
- RES. A LA HELADA
FROST PROOF
- DESTONIFICADO ARMONIOSO
CONTROLLED DESTONIFICATION



DECORACIÓN · DECORATION

Comfort floor ▶ Class I

COMBINA · COMBINE



MODELI MIX
HEX. 15 x 17 (G 54) 6" x 7" m



HEX. (10) NEW PANAL FARINA
15 x 17 (G 63) 6" x 7" m



HEX. (10) NEW PANAL CARBO
15 x 17 (G 63) 6" x 7" m

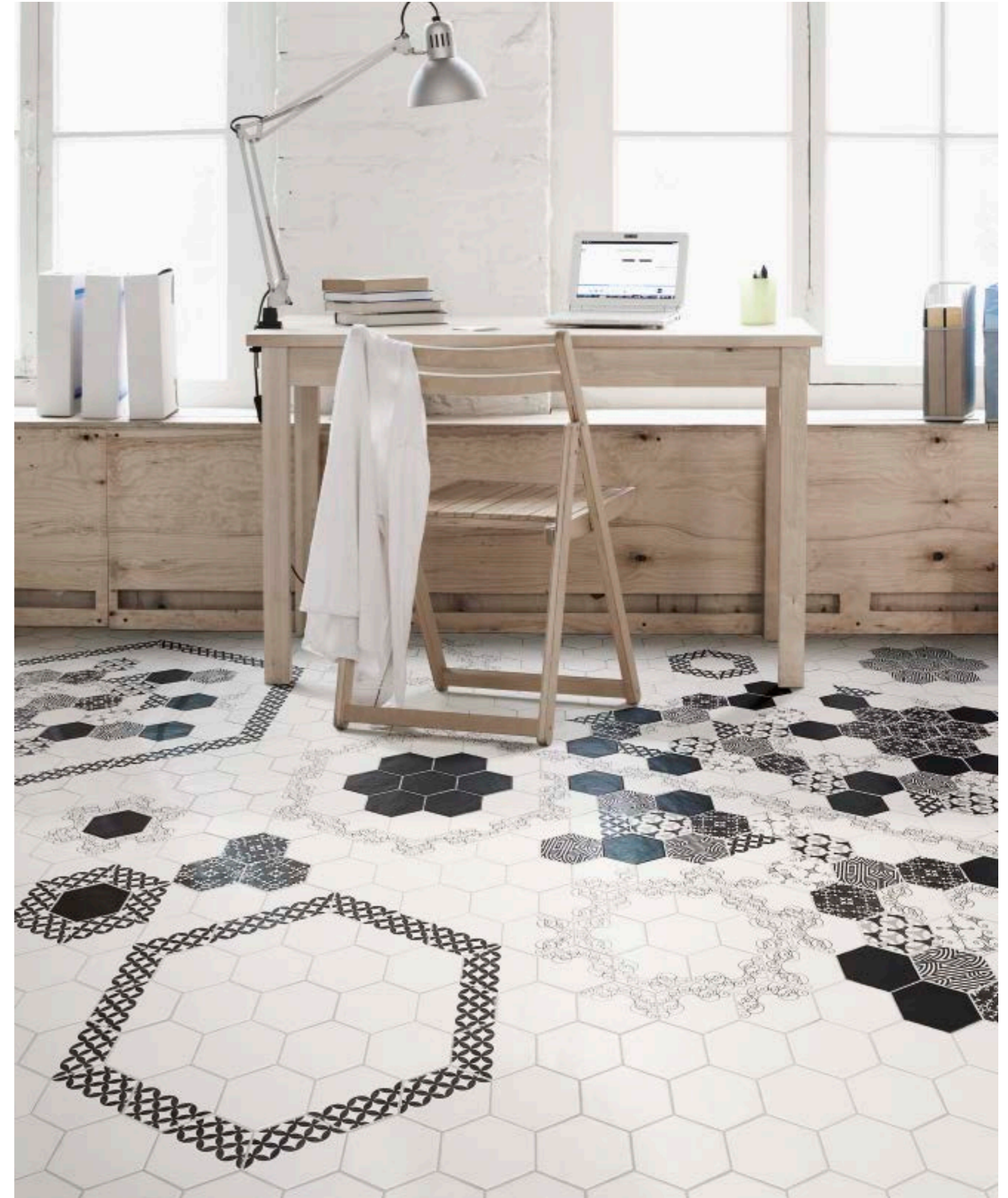

PACKING

FORMATO	PULGADAS	PZ/CAJA	M²	ML	CAJA/PLT	PESO/CAJA
HEX. 15 x 17	6" x 7"	26	0,5	80	12,45	1.010

DOLCE

D'AUTORE
CUSTOM TILES

EVOLUTION
EXTRUDED PORCELAIN TILE

PE GRES EXTRUSIONADO PORCELÁNICO
PORCELAIN EXTRUDED TILE

REVESTIMIENTO
WALL TILE

SUPERFICIE BRILLO
SURFACE BRIGTHNESS

VOLUMEN
VOLUME

FORMATOS:
13 x 13 - 5" x 5"



COLORES · COLORS



DOLCE BIANCO ALTO
13 x 13 (G 72) 5" x 5" m²



DOLCE PERLA ALTO
13 x 13 (G 53) 5" x 5" m²



DOLCE METALLO ALTO
13 x 13 (G 53) 5" x 5" m²

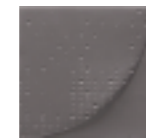

DOLCE NERO ALTO
13 x 13 (G 72) 5" x 5" m²



DOLCE BLU ALTO
13 x 13 (G 53) 5" x 5" m²



DOLCE ROSSO ALTO
13 x 13 (G 53) 5" x 5" m²



DOLCE BIANCO BASSO
13 x 13 (G 72) 5" x 5" m²



DOLCE PERLA BASSO
13 x 13 (G 53) 5" x 5" m²



DOLCE METALLO BASSO
13 x 13 (G 53) 5" x 5" m²

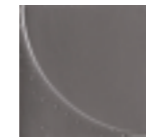

DOLCE NERO BASSO
13 x 13 (G 72) 5" x 5" m²



DOLCE BLU BASSO
13 x 13 (G 53) 5" x 5" m²



DOLCE ROSSO BASSO
13 x 13 (G 53) 5" x 5" m²



REVESTIMIENTO COORDINADO · COORDINATED WALL TILE

Pasta Blanca

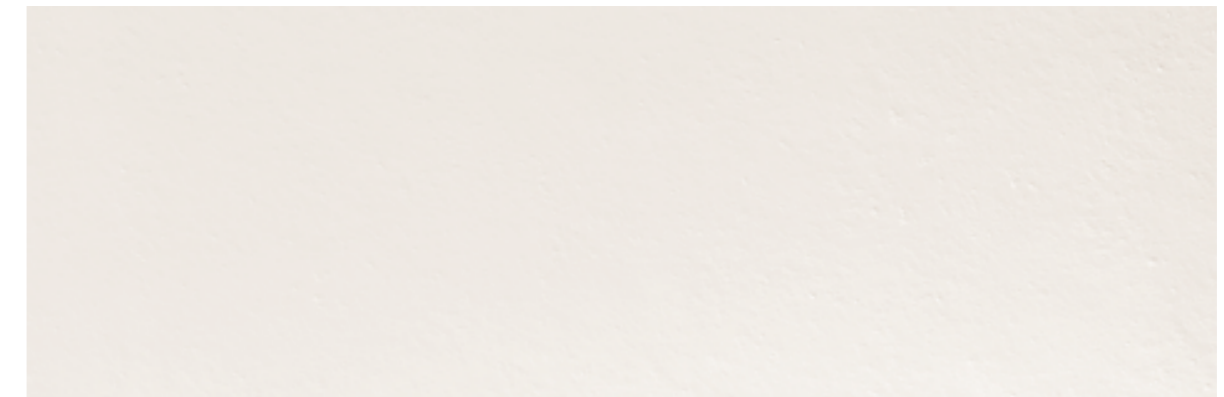

AUSTRAL WHITE
40 x 120 (G 69) 16" x 48" m²



AUSTRAL BEIGE
40 x 120 (G 69) 16" x 48" m²

PACKING BASES

FORMATO	PULGADAS	PZ/CAJA	M ²	CAJA/PLT	PESO/CAJA	PESO/PLT
13 x 13	5" x 5"	26	0,433	108	10,8	1.177

PACKING BASES

FORMATO	PULGADAS	PZ/CAJA	M ²	CAJA/PLT	PESO/CAJA	PESO/PLT
40 x 120	16" x 48"	3	1,44	20	27,2	660

VALENTINO

D'AUTORE
CUSTOM TILES

EVOLUTION
EXTRUDED PORCELAIN TILE

PE GRES EXTRUSIONADO PORCELÁNICO
PORCELAIN EXTRUDED TILE

REVESTIMIENTO
WALL TILE

SUPERFICIE BRILLO
SURFACE BRIGHTNESS

VOLUMEN
VOLUME

FORMATOS:
13 x 13 - 5" x 5"

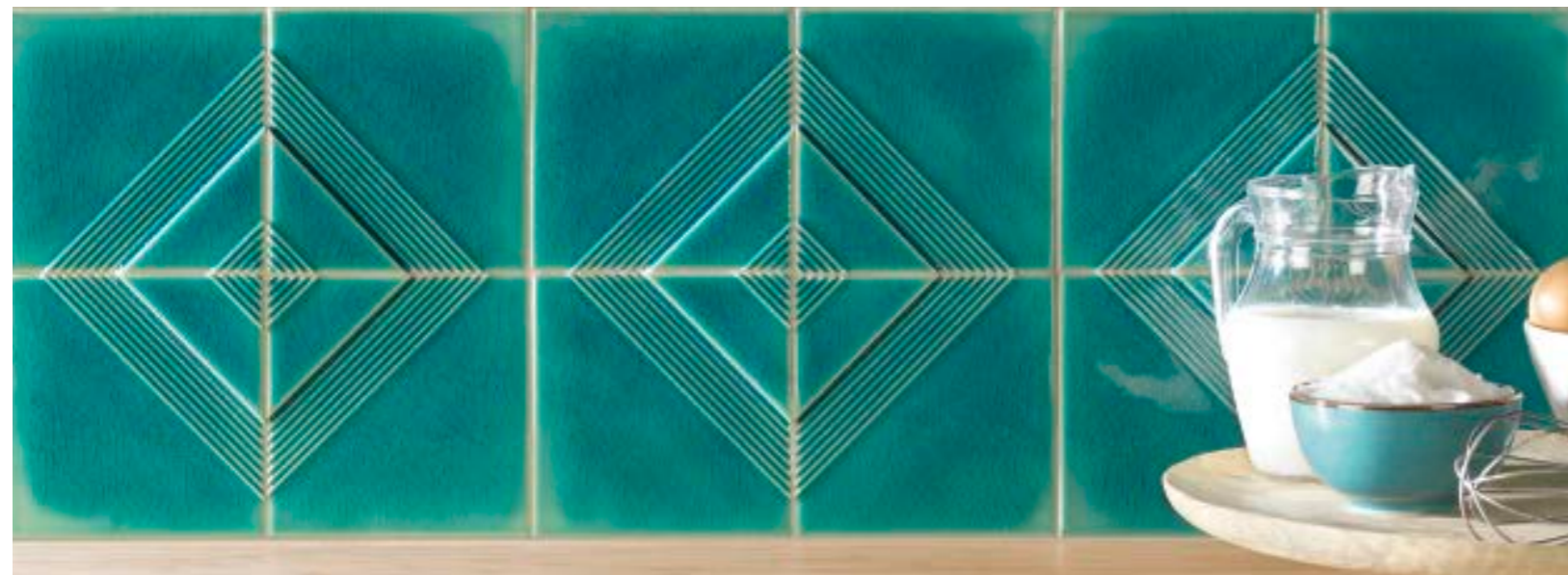

COLORES · COLORS

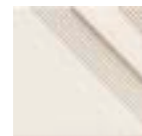

VALENTINO BIANCO
13 x 13 (G 72) 5" x 5" m²

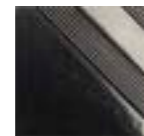

VALENTINO METALLO
13 x 13 (G 54) 5" x 5" m²



VALENTINO TURCHESE CRAQ.
13 x 13 (G 54) 5" x 5" m²



VALENTINO VERDE CRAQ.
13 x 13 (G 54) 5" x 5" m²



PACKING BASES

FORMATO	PULGADAS	PZ/CAJA	M²	CAJA/PLT	PESO/CAJA	PESO/PLT
13 x 13	5" x 5"	29	0,483	108	9,4	1.030



REVESTIMIENTO COORDINADO · COORDINATED WALL TILE

Pasta Blanca

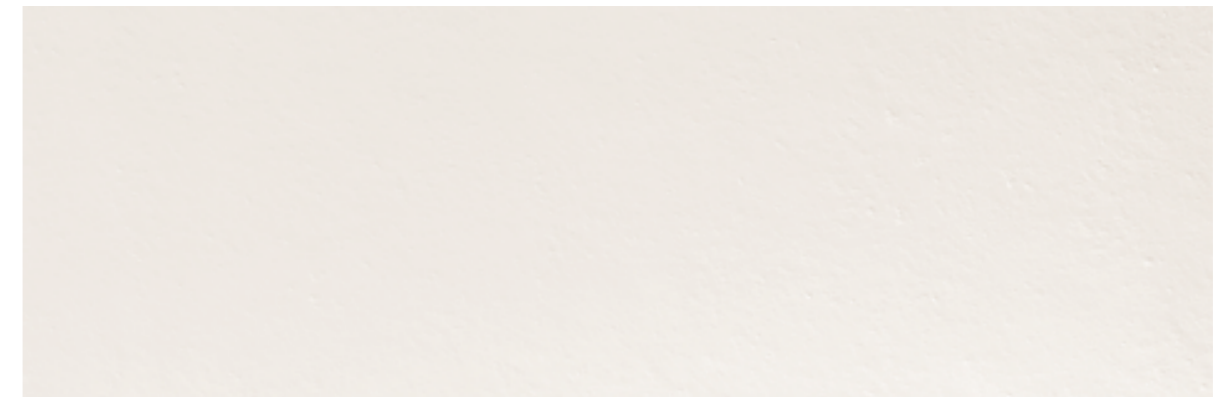

AUSTRAL WHITE
40 x 120 (G 69) 16" x 48" m²



AUSTRAL BEIGE
40 x 120 (G 69) 16" x 48" m²

PACKING BASES

FORMATO	PULGADAS	PZ/CAJA	M²	CAJA/PLT	PESO/CAJA	PESO/PLT
40 x 120	16" x 48"	3	1,44	20	27,2	660

ENZO

D'AUTORE
CUSTOM TILES

EVOLUTION
EXTRUDED PORCELAIN TILE

PE GRES EXTRUSIONADO PORCELÁNICO
PORCELAIN EXTRUDED TILE

REVESTIMIENTO
WALL TILE

SUPERFICIE BRILLO
SURFACE BRIGTHNESS

VOLUMEN
VOLUME

FORMATOS:
13 x 13 - 5" x 5"

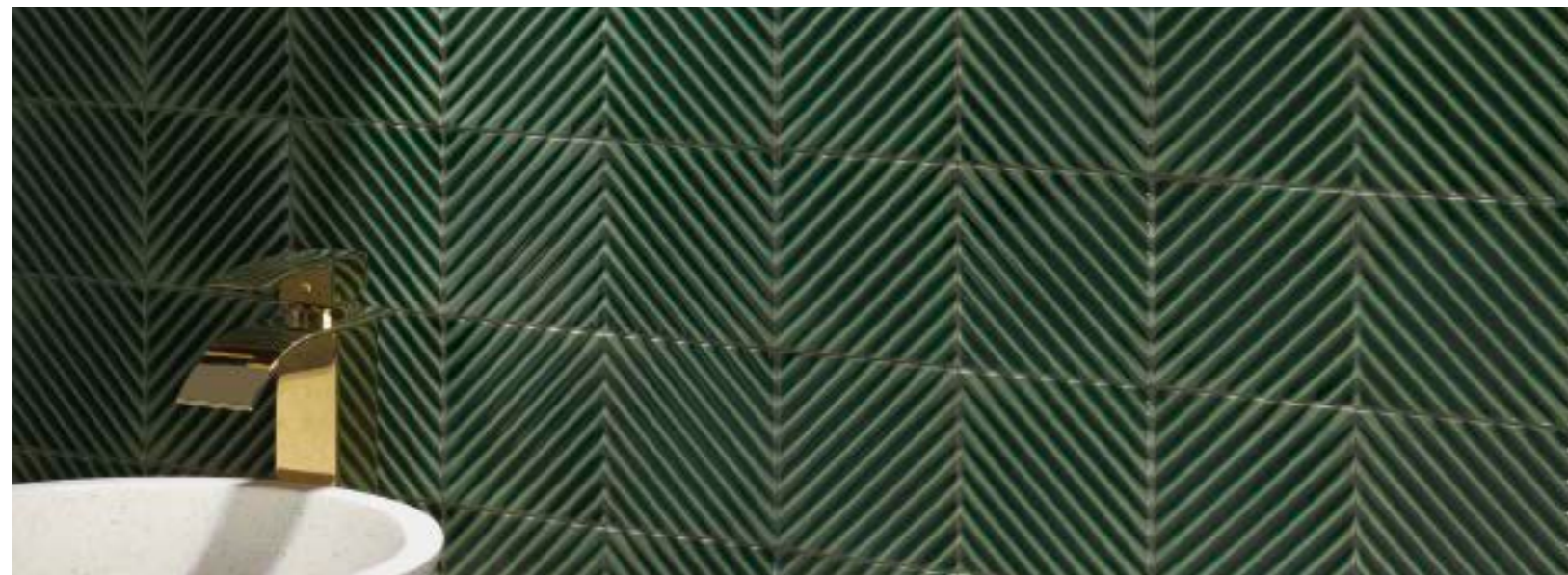

COLORES · COLORS

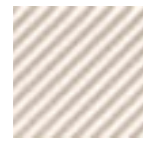

ENZO BIANCO
13 x 13 (G 72) 5" x 5" m²



ENZO METALLO
13 x 13 (G 54) 5" x 5" m²



ENZO TURCHESE CRAQ.
13 x 13 (G 54) 5" x 5" m²

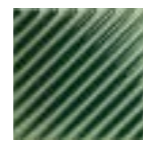

ENZO VERDE CRAQ.
13 x 13 (G 54) 5" x 5" m²



ENZO CALDAIA
13 x 13 (G 72) 5" x 5" m²



PACKING BASES

FORMATO	PULGADAS	PZ/CAJA	M ²	CAJA/PLT	PESO/CAJA	PESO/PLT
13 x 13	5" x 5"	27	0,45	108	10,9	1.193

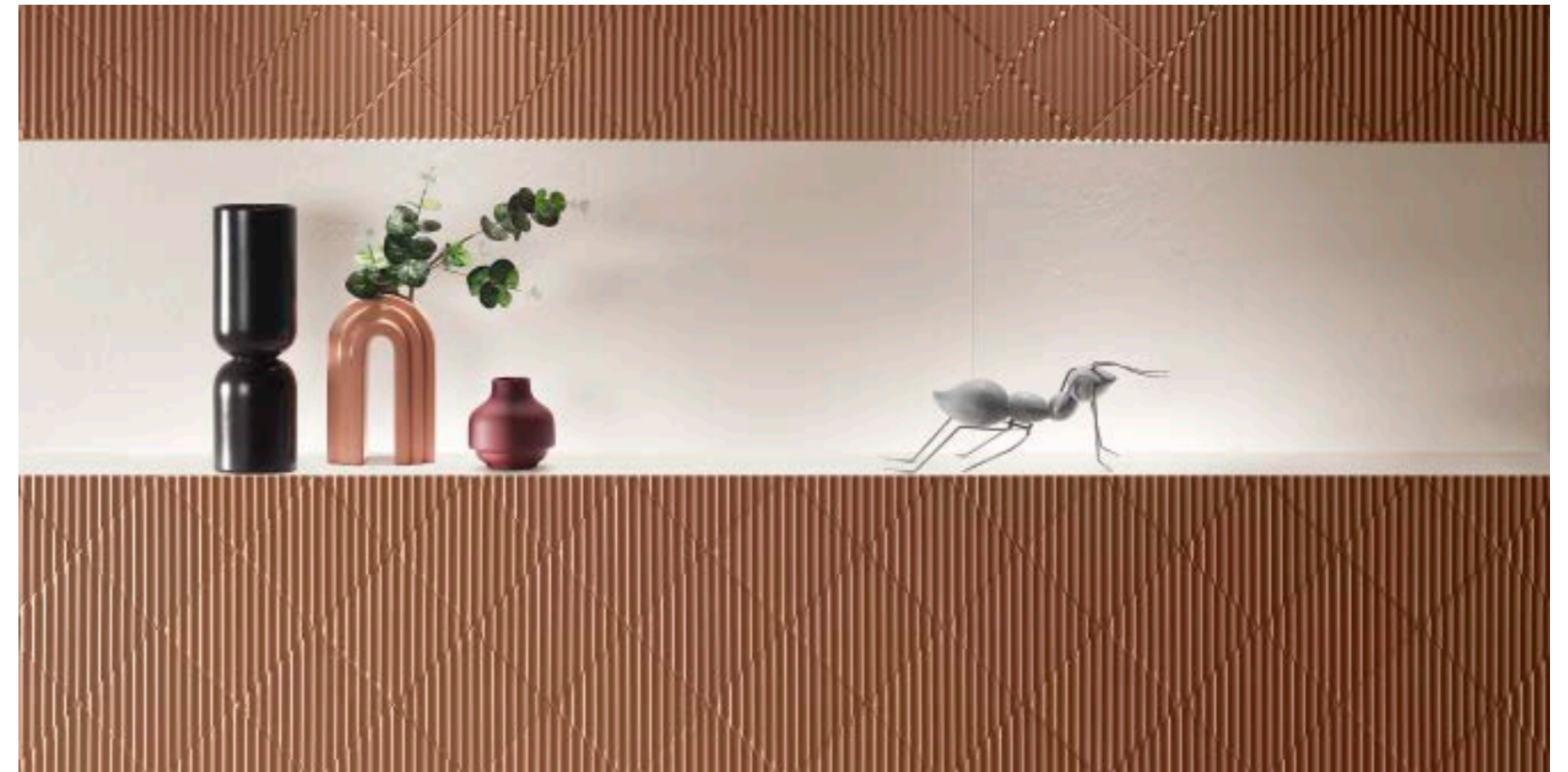

REVESTIMIENTO COORDINADO · COORDINATED WALL TILE

Pasta Blanca

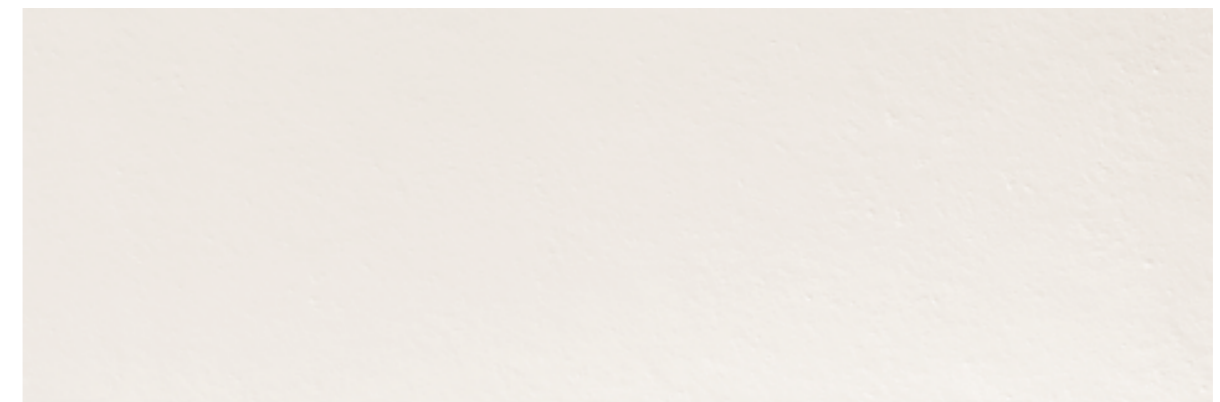

AUSTRAL WHITE
40 x 120 (G 69) 16" x 48" m²



AUSTRAL BEIGE
40 x 120 (G 69) 16" x 48" m²

PACKING BASES

FORMATO	PULGADAS	PZ/CAJA	M ²	CAJA/PLT	PESO/CAJA	PESO/PLT
40 x 120	16" x 48"	3	1,44	20	27,2	660

GIORGIO

D'AUTORE
CUSTOM TILES

EVOLUTION
EXTRUDED PORCELAIN TILE

PE GRES EXTRUSIONADO PORCELÁNICO
PORCELAIN EXTRUDED TILE

SUPERFICIE BRILLO
SURFACE BRIGTNES

SUPERFICIE SATINADO
GLOSSY SURFACE

REVESTIMIENTO
WALL TILE

VOLUMEN
VOLUME

FORMATOS:
13 x 13 - 5" x 5"

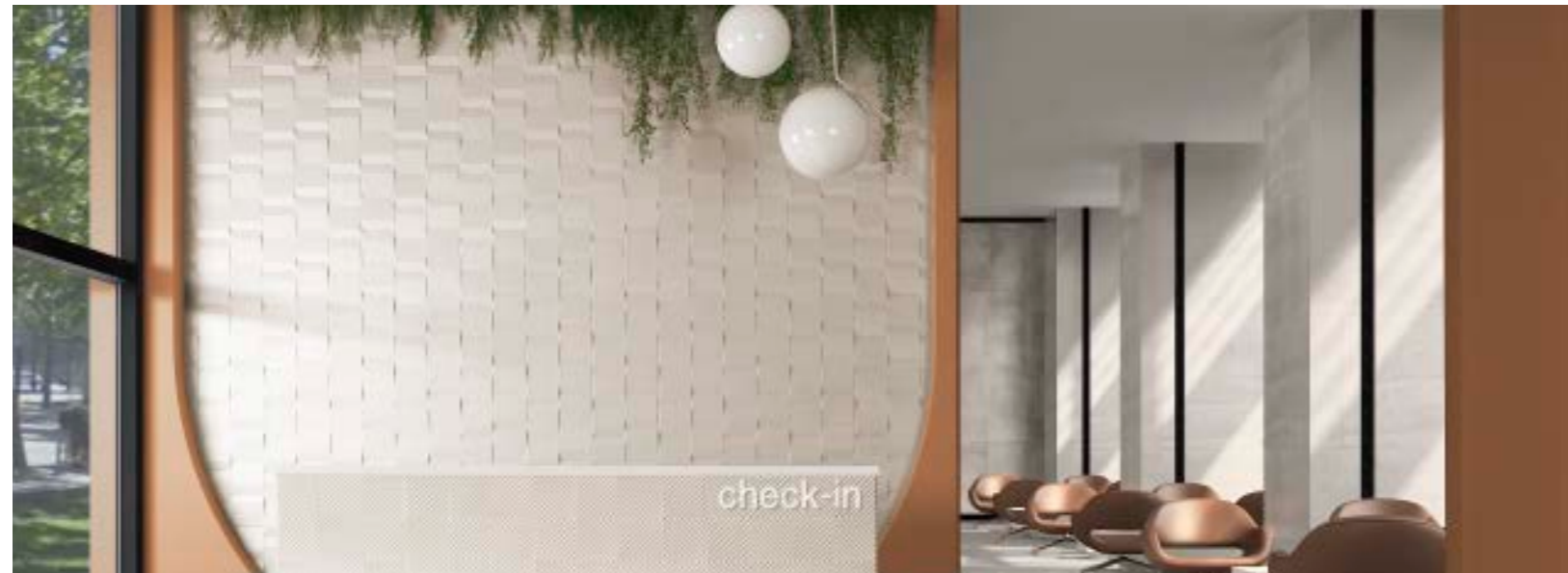

COLORES · COLORS



GIORGIO BIANCO
13 x 13 (G 72) 5" x 5" m²

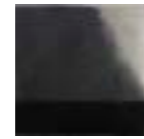

GIORGIO METALLO
13 x 13 (G 54) 5" x 5" m²



GIORGIO CALDAIA
13 x 13 (G 72) 5" x 5" m²



GIORGIO VERDE
13 x 13 (G 54) 5" x 5" m²



REVESTIMIENTO COORDINADO · COORDINATED WALL TILE

Pasta Blanca

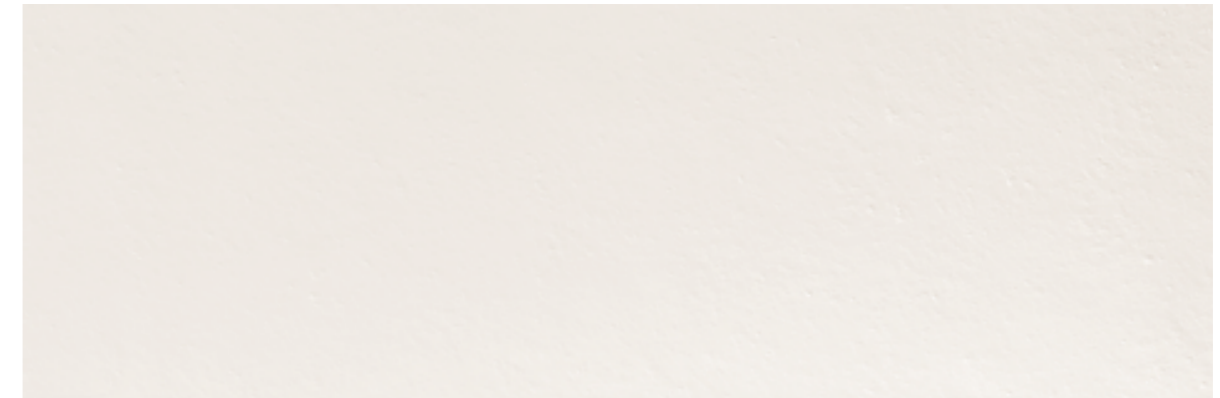

AUSTRAL WHITE
40 x 120 (G 69) 16" x 48" m²



AUSTRAL BEIGE
40 x 120 (G 69) 16" x 48" m²

PACKING BASES

FORMATO	PULGADAS	PZ/CAJA	M²	CAJA/PLT	PESO/CAJA	PESO/PLT
13 x 13	5" x 5"	23	0,383	108	10,3	1.131

PACKING BASES

FORMATO	PULGADAS	PZ/CAJA	M²	CAJA/PLT	PESO/CAJA	PESO/PLT
40 x 120	16" x 48"	3	1,44	20	27,2	660

DONNA

D'AUTORE
CUSTOM TILES

EVOLUTION
EXTRUDED PORCELAIN TILE

PE GRES EXTRUSIONADO PORCELÁNICO
PORCELAIN EXTRUDED TILE

REVESTIMIENTO
WALL TILE

FORMATOS:
10 x 20 - 4" x 8"

SUPERFICIE BRILLO
SURFACE BRIGHTNESS

VOLUMEN
VOLUME

PATRONS
[FIGURES]

EVOLUTION
EXTRUDED PORCELAIN TILE

PE GRES EXTR. PORCELÁNICO
PORCELAIN EXTRUDED TILE

REVESTIMIENTO
WALL TILE

SUPERFICIE MATE
MATT SURFACE

RESIST. A LA HELADA
FROST PROOF

RESIST. A ÁCIDOS Y BASES
RESIST. TO ACIDS & BASES

FORMATO:
15,5 x 15,5 - 6" x 6"



COLORES · COLORS



DONNA BIANCO
10 x 20 (G 72) 4" x 8" m²



DONNA NERO
10 x 20 (G 72) 4" x 8" m²



DONNA CALDAIA
10 x 20 (G 72) 4" x 8" m²



DONNA NERO AZURRO
10 x 20 (G 53) 4" x 8" m²



DONNA NERO ROSSO
10 x 20 (G 53) 4" x 8" m²



DONNA BIANCO PIÙ
10 x 20 (G 72) 4" x 8" m²



DONNA NERO PIÙ
10 x 20 (G 72) 4" x 8" m²

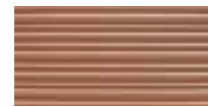

DONNA CALDAIA PIÙ
10 x 20 (G 72) 4" x 8" m²



DONNA BIANCO BLU
10 x 20 (G 53) 4" x 8" m²



DONNA BIANCO VERDE
10 x 20 (G 53) 4" x 8" m²

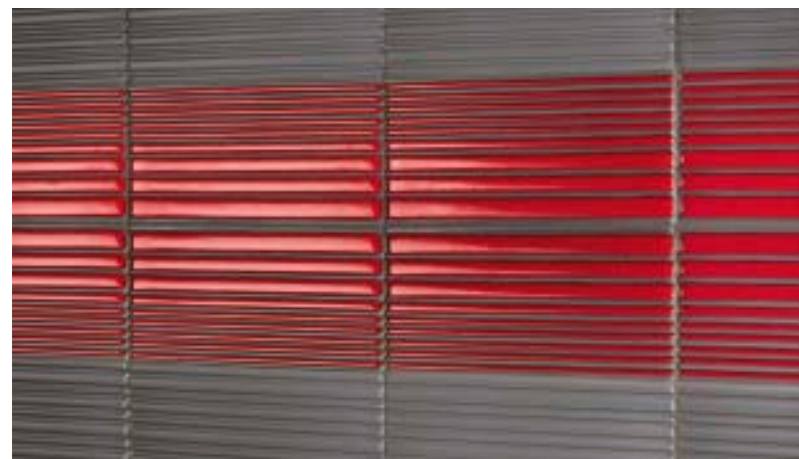

FIGURES PATRONS



FIGURES PATRONS FLETXA BIANCO
15,5 x 15,5 (G 46) 6" x 6" m²



FIGURES PATRONS PLEC BIANCO
15,5 x 15,5 (G 46) 6" x 6" m²



FIGURES PATRONS FLETXA NOTTE
15,5 x 15,5 (G 46) 6" x 6" m²



FIGURES PATRONS PLEC NOTTE
15,5 x 15,5 (G 46) 6" x 6" m²

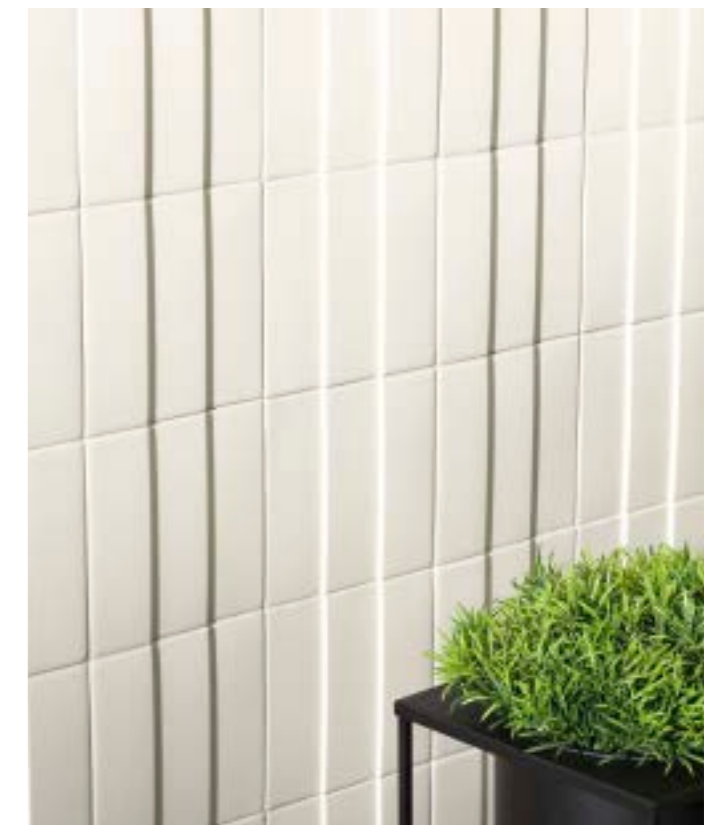

Las series D'AUTORE combinan con las bases de la serie AUSTRAL pág. 118-119
D'AUTORE combines with AUSTRAL collection, pág. 118-119

PACKING BASES

FORMATO	PULGADAS	PZ/CAJA	M²	CAJA/PLT	PESO/CAJA	PESO/PLT
10 x 20	4" x 8"	32	0,64	96	13,2	1,285

PACKING BASES

FORMATO	PULGADAS	PZ/CAJA	M²	CAJA/PLT	PESO/CAJA	PESO/PLT
FLETXA 15,5x15,5	6" x 6"	20	0,48	80	13,06	1,067,80
PLEC 15,5x15,5	6" x 6"	22	0,53	80	13,31	1,087,80



COLORES · COLORS

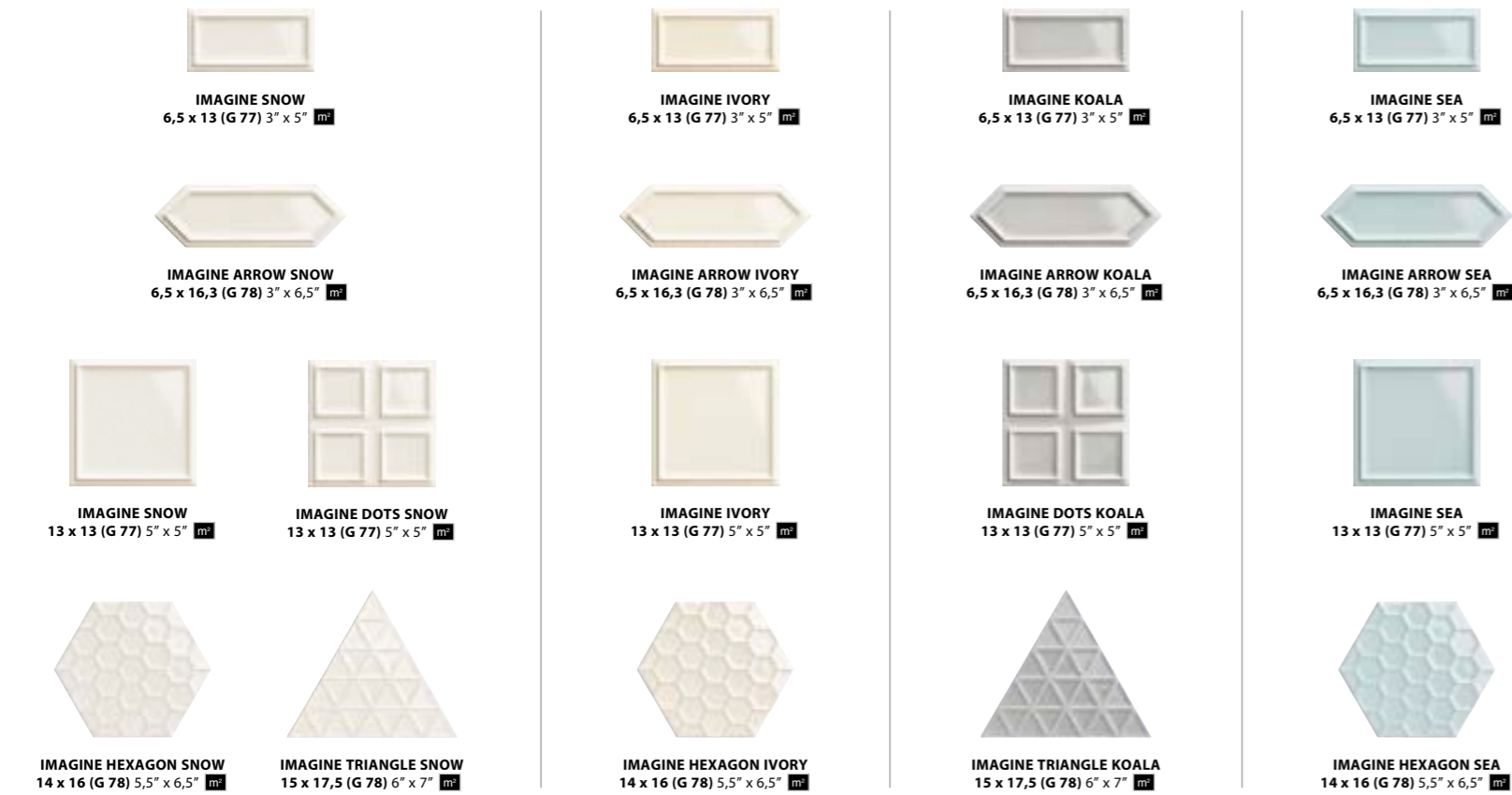

REVESTIMIENTO COORDINADO · COORDINATED WALL TILE

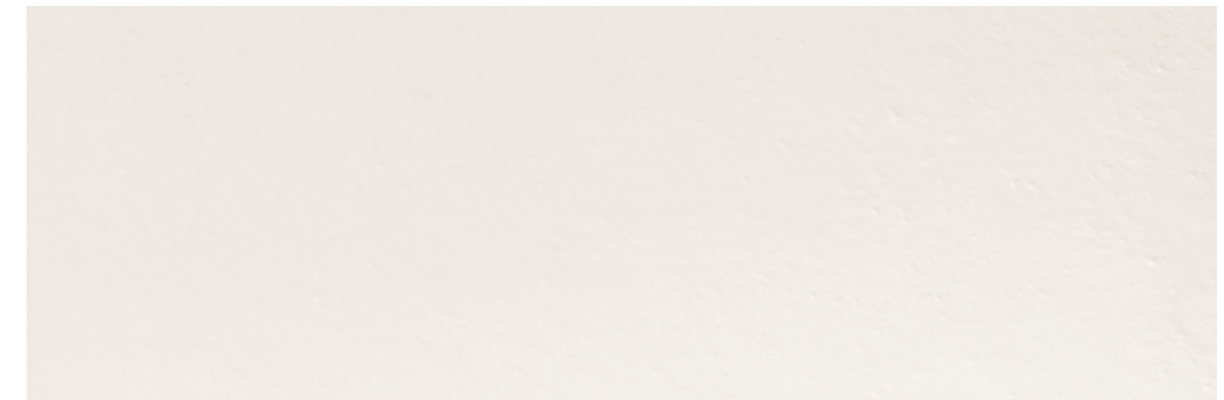

AUSTRAL WHITE
40 x 120 (G 69) 16" x 48"



AUSTRAL BEIGE
40 x 120 (G 69) 16" x 48"

PACKING BASES

FORMATO	PULGADAS	PZ/CAJA	M²	CAJA/PLT	PESO/CAJA	PESO/PLT
6,5 x 13	3" x 5"	60	0,51	108	7,6	835
6,5 x 16,3 ARROW	3" x 6,5"	48	0,51	90	7,78	715
13 x 13 / 13 x 13 DOTS	5" x 5"	30	0,5	108	7,95	874

PACKING BASES

FORMATO	PULGADAS	PZ/CAJA	M²	CAJA/PLT	PESO/CAJA	PESO/PLT
14 x 16 HEXAGON	5" x 6"	31	0,52	95	7,39	717
15 x 17,5 TRIANGLE	6" x 7"	39	0,51	108	7,20	793

PACKING BASES

FORMATO	PULGADAS	PZ/CAJA	M²	CAJA/PLT	PESO/CAJA	PESO/PLT
40 x 120	16" x 48"	3	1,44	20	27,2	660



CUSTOM TILES



IMAGINE PURPLE
6,5 x 13 (G 66) 3" x 5" 



IMAGINE RED
6,5 x 13 (G 66) 3" x 5" 



IMAGINE BLUE
6,5 x 13 (G 66) 3" x 5" 



IMAGINE OLIVE
6,5 x 13 (G 66) 3" x 5" 



IMAGINE ARROW PURPLE
6,5 x 16,3 (G 66) 3" x 6,5" 



IMAGINE ARROW RED
6,5 x 16,3 (G 66) 3" x 6,5" 



IMAGINE ARROW BLUE
6,5 x 16,3 (G 66) 3" x 6,5" 



IMAGINE ARROW OLIVE
6,5 x 16,3 (G 66) 3" x 6,5" 



IMAGINE DOTS PURPLE
13 x 13 (G 66) 5" x 5" 



IMAGINE DOTS RED
13 x 13 (G 66) 5" x 5" 



IMAGINE DOTS BLUE
13 x 13 (G 66) 5" x 5" 



IMAGINE DOTS OLIVE
13 x 13 (G 66) 5" x 5" 

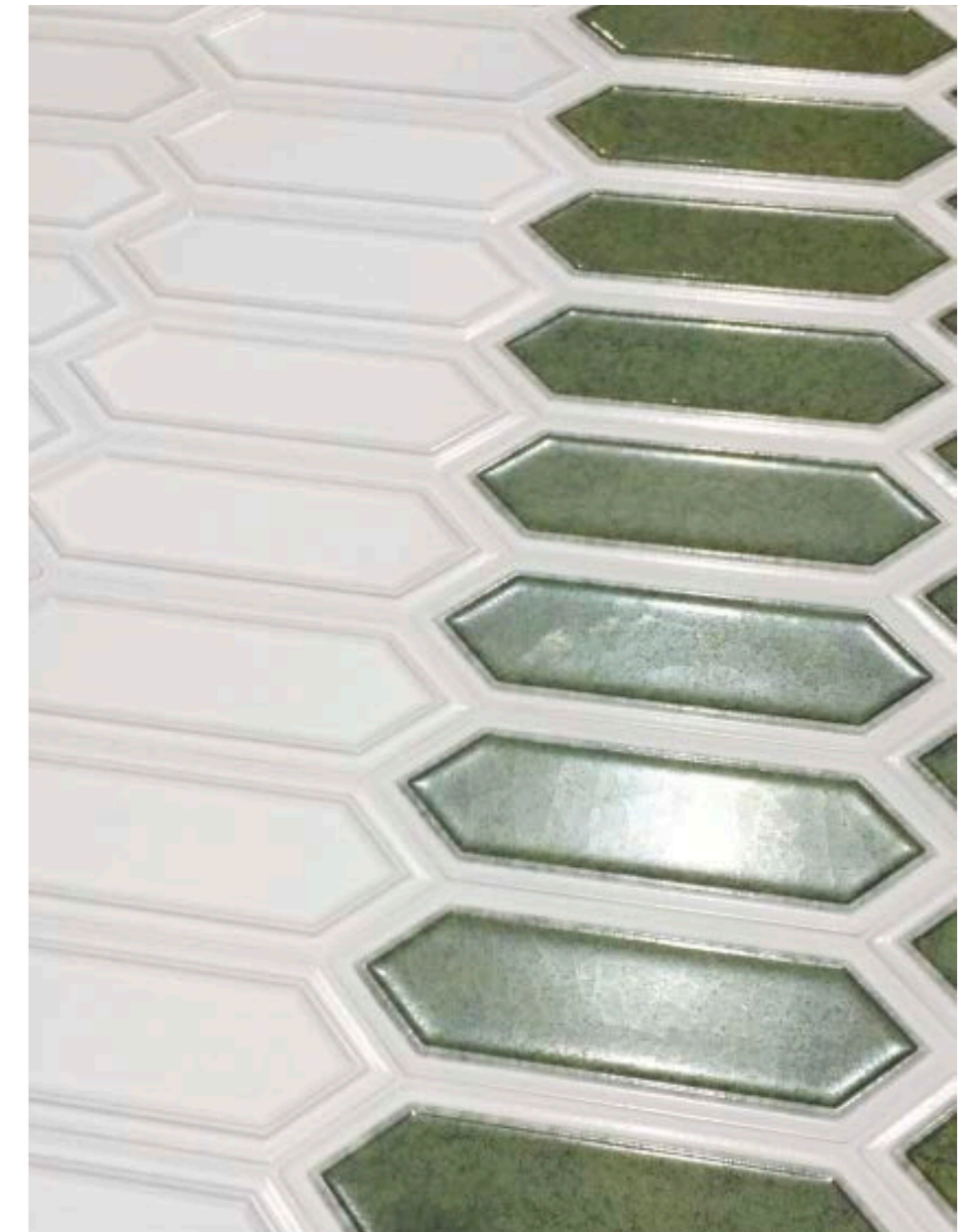





PACKING BASES

FORMATO	PULGADAS	PZ/CAJA	M ²	CAJA/PLT	PESO/CAJA	PESO/PLT
6,5 x 13	3" x 5"	60	0,51	108	7,6	835
6,5 x 16,3 ARROW	3" x 6,5"	48	0,51	90	7,78	715
13 x 13	5" x 5"	30	0,5	108	7,95	874

FIKA

Pasta Blanca

-  SUPERFICIE MATE
MATT SURFACE
-  REVESTIMIENTO
WALL TILE
-  MODULAR
MODULARITY
-  BORDES Y SUPERFICIE IRREGULAR
IRREGULAR EDGES AND SURFACE

FORMATOS:
 10 x 10 - 4" x 4"
 10 x 20 - 4" x 8"
 20 x 60 - 8" x 24"
 ENM. 30,5 x 30,5 - 12" x 12"



COLORES · COLORS



FIKA SKY
 10 x 10 (G 77) 4" x 4"
 ENM. 30,5 x 30,5 (G 60) 12" x 12"



FIKA BIANCO
 10 x 10 (G 77) 4" x 4"
 ENM. 30,5 x 30,5 (G 60) 12" x 12"

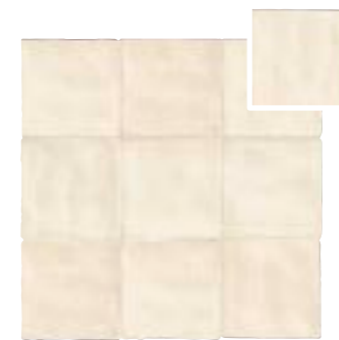

FIKA OFF WHITE
 10 x 10 (G 77) 4" x 4"
 ENM. 30,5 x 30,5 (G 60) 12" x 12"



FIKA COTTO
 10 x 10 (G 77) 4" x 4"
 ENM. 30,5 x 30,5 (G 60) 12" x 12"



FIKA MARSALA
 10 x 10 (G 77) 4" x 4"
 ENM. 30,5 x 30,5 (G 60) 12" x 12"



FIKA KALE
 10 x 10 (G 77) 4" x 4"
 ENM. 30,5 x 30,5 (G 60) 12" x 12"



FIKA FOSSIL
 10 x 10 (G 77) 4" x 4"
 ENM. 30,5 x 30,5 (G 60) 12" x 12"

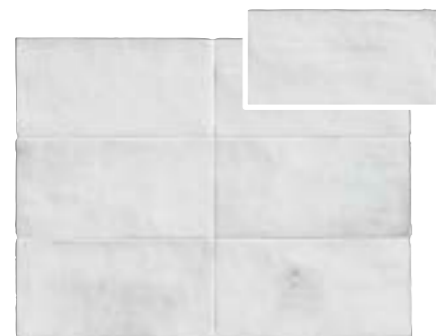

FIKA SKY
 10 x 20 (G 77) 4" x 8"



FIKA BIANCO
 10 x 20 (G 77) 4" x 8"



FIKA OFF WHITE
 10 x 20 (G 77) 4" x 8"



FIKA BIANCO
 20 x 60 (G 27) 8" x 24"



FIKA CLEAR
 20 x 60 (G 27) 8" x 24"

PACKING BASES

FORMATO	PULGADAS	PZ/CAJA	M ²	CAJA/PLT	PESO/CAJA	PESO/PLT
10 x 10	4" x 4"	56	0,56	112	8,22	935
10 x 20	4" x 8"	50	1	60	17,35	1.056
ENM. 30,5 x 30,5	12" x 12"	11	1,02	60	22	1.335
20 x 60	8" x 24"	8	0,96	32	15	495
40 x 120	16" x 48"	3	1,44	20	27,2	660

PACKING PIEZAS ESPECIALES

FORMATO	PULGADAS	PZ/CAJA	ML	CAJA/PLT	PESO/CAJA	PESO/PLT
DEMI-BULLNOSE 1,5 x 30	0,6" x 11,8"	50	15	120	2,2	276

REVESTIMIENTO COORDINADO · COORDINATED WALL TILE

La serie FIKA combina con las bases de la serie AUSTRAL pág. 118-119
 FIKA combines with AUSTRAL collection, pág. 118-119

AUSTRAL

Pasta Blanca

RECT RECTIFICADO
RECTIFIED



40 x 120 (G69)
 16" x 48" m²

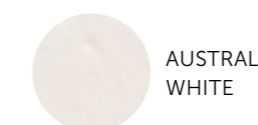

AUSTRAL
WHITE

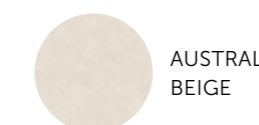

AUSTRAL
BEIGE

PIEZAS ESPECIALES · SPECIAL PIECES

Disponibles en todos los colores · Available in all colors



DEMI-BULLNOSE
 1,5 x 30 (G 07) 0,6" x 11,8" ♦

FAN

Pasta Blanca

 SUPERFICIE BRILLO
SURFACE BRIGTNES

 SUPERFICIE MATE
MATT SURFACE

 REVESTIMIENTO
WALL TILE

 DESTONIFICADO ARMONIOSO
CONTROLLED DESTONIFICATION

FORMATOS:
FAN 7,2x19,5-3" x 8"
7,2 x 22,2-3" x 8,7"



BRILLO · GLOSSY

MATE · MATT



LONDON WHITE
7,2 x 22,2 (G 58) 3" x 8,7" m²



FAN WHITE
7,2 x 19,5 (G 60) 3" x 8" m²



FAN MIX ASH
7,2 x 19,5 (G 60) 3" x 8" m²



FAN MIX ACQUA
7,2 x 19,5 (G 60) 3" x 8" m²



FAN MIX TURCHESE
7,2 x 19,5 (G 60) 3" x 8" m²



FAN MIX BLACK
7,2 x 19,5 (G 60) 3" x 8" m²



CLEAR MATT
7,2 x 22,2 (G 58) 3" x 8,7" m²



FAN CLEAR MATT
7,2 x 19,5 (G 60) 3" x 8" m²



FAN FOG MATT
7,2 x 19,5 (G 60) 3" x 8" m²

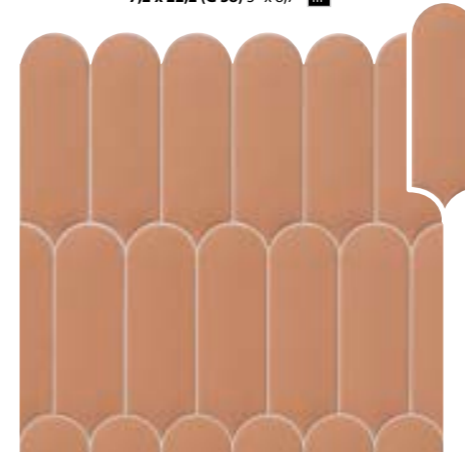

FAN CLAY MATT
7,2 x 19,5 (G 60) 3" x 8" m²

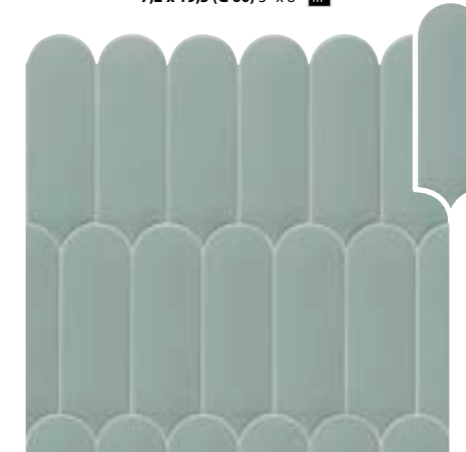

FAN MARINE MATT
7,2 x 19,5 (G 60) 3" x 8" m²



FAN DARK MATT
7,2 x 19,5 (G 60) 3" x 8" m²

PACKING BASES

FORMATO	PULGADAS	PZ/CAJA	M ²	CAJA/PLT	PESO/CAJA	PESO/PLT
7,2 x 22,2	3" x 8,7"	30	0,48	120	7,66	935
7,2 x 19,5	3" x 8"	34	0,48	120	7,55	925

EVOKE

Pasta Blanca

REVESTIMIENTO WALL TILE

SUPERFICIE SATINADO GLOSSY SURFACE

BORDES Y SUPERFICIE IRREGULAR IRREGULAR EDGES AND SURFACE

FORMATOS:
6,5 x 26 - 2,5" x 10,2"



COLORES · COLORS



EVOKE CLEAR
6,5 x 26 (G 76) 2,5" x 10,2" m²



EVOKE LINEN
6,5 x 26 (G 76) 2,5" x 10,2" m²



EVOKE SKIN
6,5 x 26 (G 76) 2,5" x 10,2" m²



EVOKE CLAY
6,5 x 26 (G 76) 2,5" x 10,2" m²



EVOKE KALE
6,5 x 26 (G 76) 2,5" x 10,2" m²



EVOKE LAKE
6,5 x 26 (G 76) 2,5" x 10,2" m²



EVOKE CEMENT
6,5 x 26 (G 76) 2,5" x 10,2" m²



EVOKE DARK
6,5 x 26 (G 76) 2,5" x 10,2" m²

REVESTIMIENTO COORDINADO · COORDINATED WALL TILE

La serie EVOKE combina con las bases de la serie AUSTRAL pág. 118-119
EVOKE combines with AUSTRAL collection, pág. 118-119

AUSTRAL

Pasta Blanca

RECTIFICADO RECTIFIED



40 x 120 (G69)
16" x 48" m²



AUSTRAL
WHITE



AUSTRAL
BEIGE

PIEZAS ESPECIALES · SPECIAL PIECES

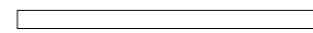

PENCIL
2,5 x 30 (G 10) 1" x 11,8" ♦



DEMI-BULLNOSE
1,5 x 30 (G 07) 0,6" x 11,8" ♦



PACKING BASES

FORMATO	PULGADAS	PZ/CAJA	M ²	CAJA/PLT	PESO/CAJA	PESO/PLT
6,5 x 26	2,5" x 10,2"	30	0,5	138	7,56	1.073

PACKING PIEZAS ESPECIALES

FORMATO	PULGADAS	PZ/CAJA	ML	CAJA/PLT	PESO/CAJA	PESO/PLT
DEMI-BULLNOSE 1,5 x 30	0,6" x 11,8"	50	15	120	2,2	276
PENCIL 2,5 x 30	1" x 11,8"	30	9	196	2	410

AUSTRAL

Pasta Blanca

REVESTIMIENTO
WALL TILE

SUPERFICIE SATINADO
GLOSSY SURFACE

RECT RECTIFICADO
RECTIFIED

FORMATO
40 x 120 - 16" x 48"



COLORES · COLORS

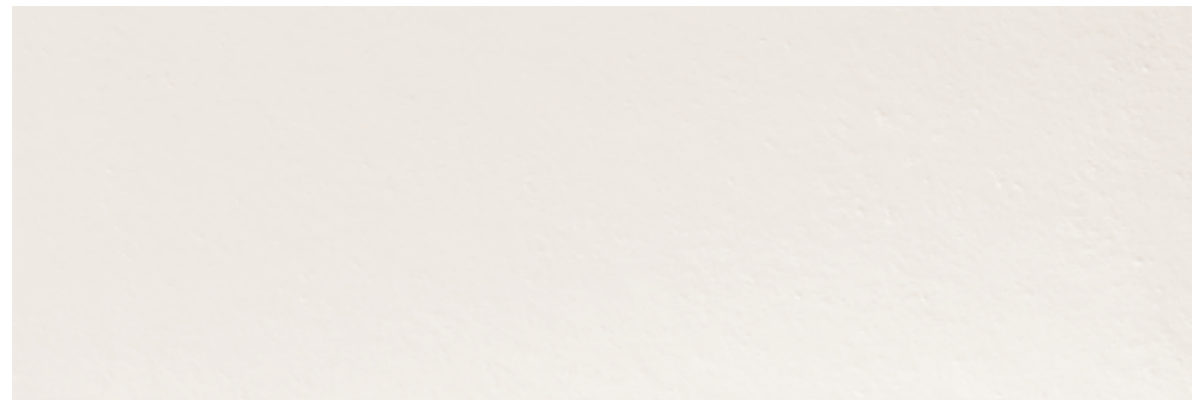

AUSTRAL WHITE
40 x 120 (G 69) 16" x 48" 



AUSTRAL BEIGE
40 x 120 (G 69) 16" x 48" 

PACKING BASES

FORMATO	PULGADAS	PZ/CAJA	M ²	CAJA/PLT	PESO/CAJA	PESO/PLT
40 x 120	16" x 48"	3	1,44	20	27,2	660

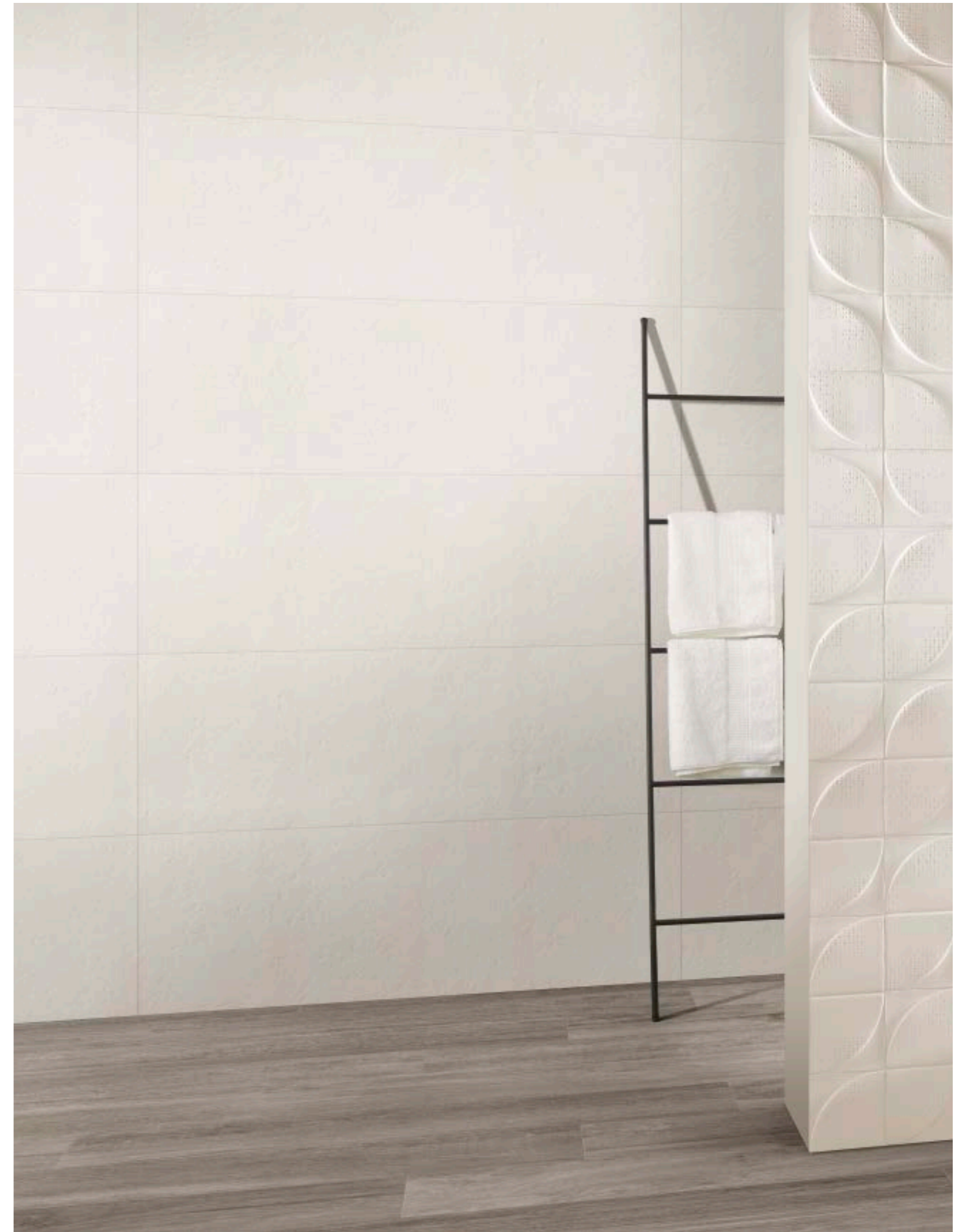

BELLA

Pasto Blanca

EFFECT
MICRO CRAQUELÉ

PILLOW EFFECT

 SUPERFICIE BRILLO
SURFACE BRIGTNES

 REVESTIMIENTO
WALL TILE

FORMATOS
7,5 x 15 - 3" x 6"

 SUPERFICIE MATE
MATT SURFACE

 SIN MANTENIMIENTO
NO MAINTENANCE



MATE - MATT



BELLA BIANCA MATTE
7,5 x 15 (G 59) 3" x 6" m²

BRILLO - GLOSSY



BELLA CRAQUELÉ BIANCA
7,5 x 15 (G 59) 3" x 6" m²



BELLA CRAQUELÉ BEIGE
7,5 x 15 (G 59) 3" x 6" m²



BELLA CRAQUELÉ GRIGIA
7,5 x 15 (G 59) 3" x 6" m²

PIEZAS ESPECIALES - SPECIAL PIECES

Disponibles en todos los colores - Availables in all colors

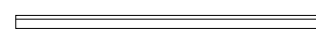

DEMI-BULLNOSE
1,5 x 30 (G 07) 0,6" x 12"



BELLA CRAQUELÉ ROSA
7,5 x 15 (G 59) 3" x 6" m²



BELLA CRAQUELÉ MENTA
7,5 x 15 (G 59) 3" x 6" m²



BELLA CRAQUELÉ AZURRA
7,5 x 15 (G 59) 3" x 6" m²



EFFECT
MICRO CRAQUELÉ

PACKING BASES

FORMATO	PULGADAS	PZ/CAJA	M ²	CAJA/PLT	PESO/CAJA	PESO/PLT
7,5 x 15	3" x 6"	44	0,5	120	8,5	1.034

PACKING PIEZAS ESPECIALES

FORMATO	PULGADAS	PZ/CAJA	ML	CAJA/PLT	PESO/CAJA	PESO/PLT
DEMI-BULLNOSE 1,5 x 30	0,6" x 12"	50	15	120	2,2	276

BELLA

EVOLUTION
EXTRUDED PORCELAIN TILE

PE GRES EXTRUSIONADO PORCELÁNICO
PORCELAIN EXTRUDED TILE

SUPERFICIE BRILLO
SURFACE BRIGTNSS

SUPERFICIE MATE
MATT SURFACE

REVESTIMIENTO
WALL TILE

RESIST. A LA HELADA
FROST PROOF

SIN MANTENIMIENTO
NO MAINTENANCE

FORMATOS

7,5 x 30 - 3" x 12"
HEXAGONO 18 x 20,5 - 7" x 8"



MATE · MATT

fine **RESISTANCE** ▶ R11 - Class III

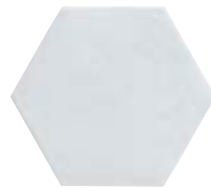

BELLA AZURRA HEX
18 x 20,5 (G 39) 7" x 8" **mm**

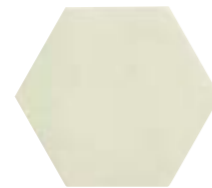

BELLA MENTA HEX
18 x 20,5 (G 39) 7" x 8" **mm**



BELLA ROSA HEX
18 x 20,5 (G 39) 7" x 8" **mm**



BELLA GRIGIA HEX
18 x 20,5 (G 39) 7" x 8" **mm**



BELLA BEIGE HEX
18 x 20,5 (G 39) 7" x 8" **mm**

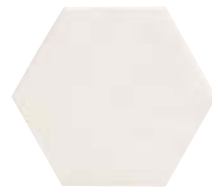

BELLA BIANCA HEX
18 x 20,5 (G 39) 7" x 8" **mm**

BRILLO · GLOSSY



BELLA AZURRA
7,5 x 30 (G 58) 3" x 12" **mm**



BELLA MENTA
7,5 x 30 (G 58) 3" x 12" **mm**



BELLA ROSA
7,5 x 30 (G 58) 3" x 12" **mm**



BELLA GRIGIA
7,5 x 30 (G 58) 3" x 12" **mm**



BELLA BEIGE
7,5 x 30 (G 58) 3" x 12" **mm**



BELLA BIANCA
7,5 x 30 (G 58) 3" x 12" **mm**

PACKING BASES

FORMATO	PULGADAS	PZ/CAJA	M ²	CAJA/PLT	PESO/CAJA	PESO/PLT
HEX. 18 x 20,5	7" x 8"	36	1	48	21	1,024
7,5 x 30	3" x 12"	22	0,5	120	8,5	1,034

ZELLIGE

Pasta Blanca



REVESTIMIENTO
WALL TILE

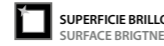

SUPERFICIE BRILLO
SURFACE BRIGTNES



DESTONIFICADO ARMONIOSO
CONTROLLED DESTONIFICATION

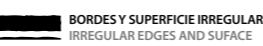

BORDES Y SUPERFICIE IRREGULAR
IRREGULAR EDGES AND SUFACE

FORMATOS:
6,2 x 25 - 2,5" x 10"

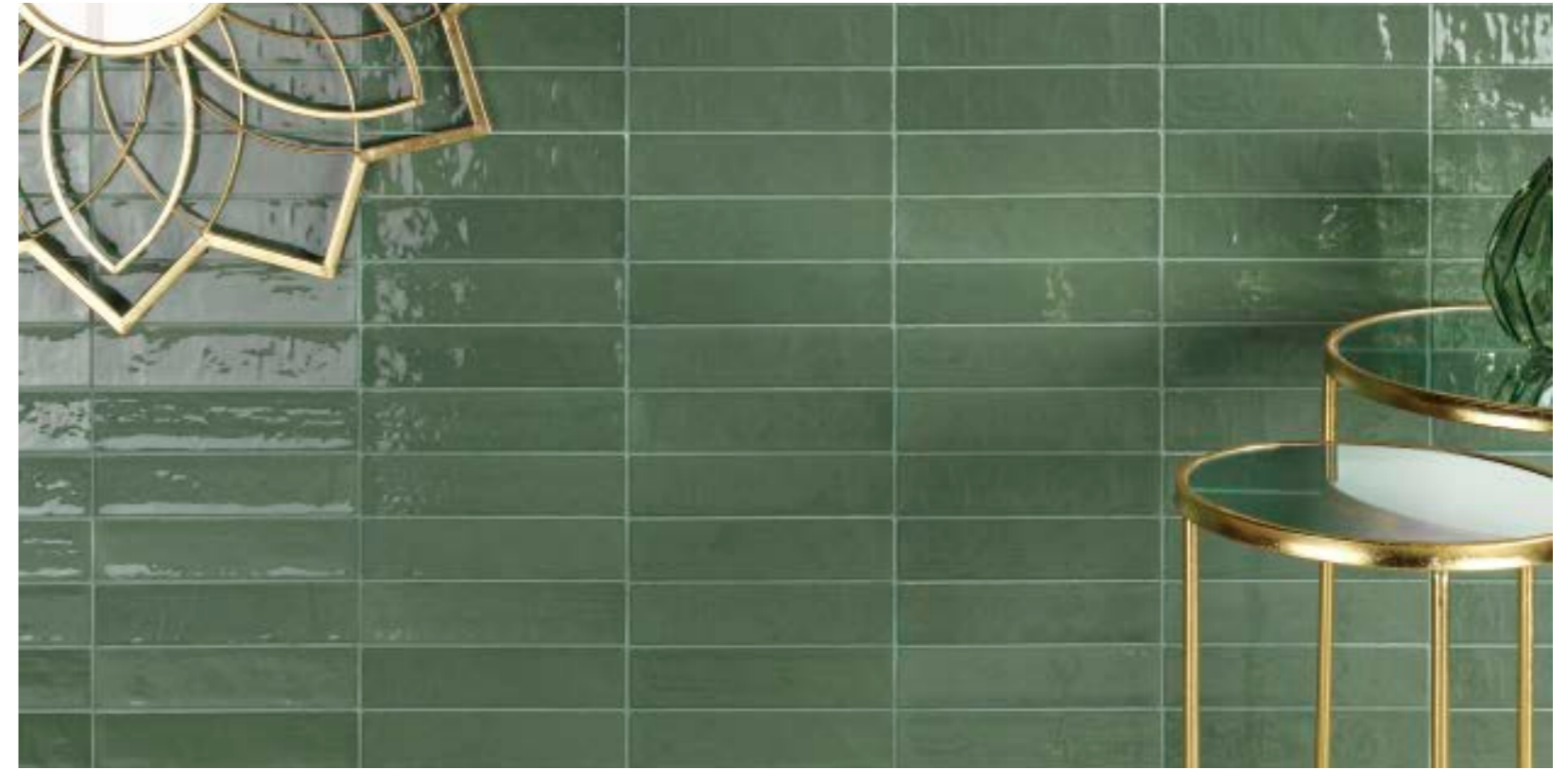

MATE - MATT

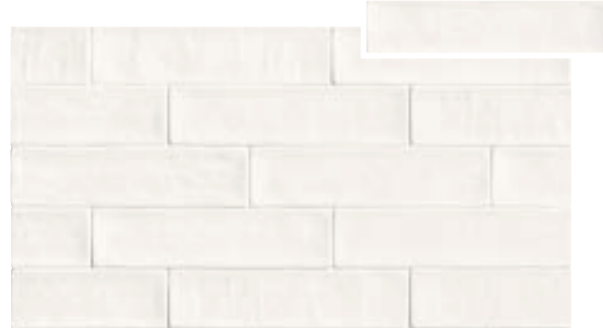

ZELLIGE WHITE MATT
6,2 x 25 (G 27) 2,5" x 10" m²

COLORES - COLORS

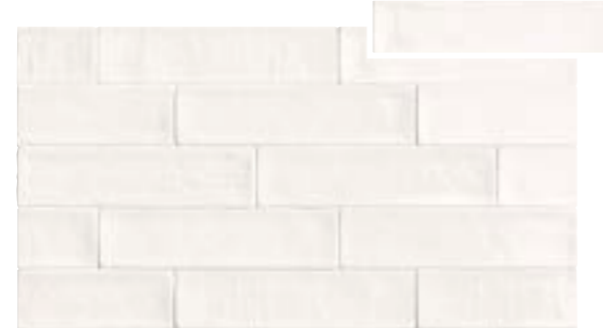

ZELLIGE WHITE
6,2 x 25 (G 27) 2,5" x 10" m²

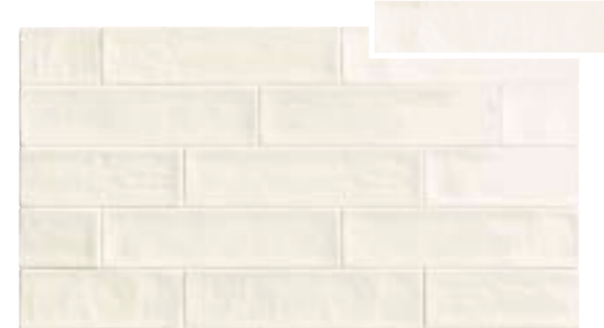

ZELLIGE BEIGE
6,2 x 25 (G 27) 2,5" x 10" m²



ZELLIGE GREY
6,2 x 25 (G 27) 2,5" x 10" m²

PIEZAS ESPECIALES - SPECIAL PIECES

Disponibles en todos los colores - Availables in all colors

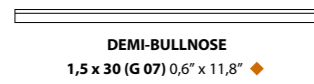

DEMI-BULLNOSE
1,5 x 30 (G 07) 0,6" x 11,8" ◆



ZELLIGE ANTIQUE
6,2 x 25 (G 27) 2,5" x 10" m²



ZELLIGE ROSE
6,2 x 25 (G 27) 2,5" x 10" m²



ZELLIGE GREEN
6,2 x 25 (G 27) 2,5" x 10" m²



ZELLIGE BLUE
6,2 x 25 (G 27) 2,5" x 10" m²



ZELLIGE BLACK
6,2 x 25 (G 27) 2,5" x 10" m²

PACKING BASES

FORMATO	PULGADAS	PZ/CAJA	M ²	CAJA/PLT	PESO/CAJA	PESO/PLT
6,2 x 25	2,5" x 10"	32	0,496	138	7,46	1.045

PACKING PIEZAS ESPECIALES

FORMATO	PULGADAS	PZ/CAJA	ML	CAJA/PLT	PESO/CAJA	PESO/PLT
DEMI-BULLNOSE 1,5 x 30	0,6" x 11,8"	50	15	120	2,2	276

CONVEX MIX

Pasta Blanca

REVESTIMIENTO
WALL TILE

SUPERFICIE BRILLO
SURFACE BRIGTNES

VOLUMEN
VOLUME

FORMATOS:
5 x 25 - 2" x 10"



MATE - MATT



BRILLO - GLOSSY



CONVEX CALÇ MATT
5 x 25 (G 60) 2" x 10"



CONVEX CALÇ
5 x 25 (G 60) 2" x 10"

BRILLO - GLOSSY



CONVEX ROSE MIX
5 x 25 (G 60) 2" x 10"



CONVEX ACQUA MIX
5 x 25 (G 60) 2" x 10"



CONVEX ASH MIX
5 x 25 (G 60) 2" x 10"



CONVEX TURCHESE MIX
5 x 25 (G 60) 2" x 10"



CONVEX GREY MIX
5 x 25 (G 60) 2" x 10"



CONVEX OLIVE MIX
5 x 25 (G 60) 2" x 10"

PACKING BASES

FORMATO	PULGADAS	PZ/CAJA	M²	CAJA/PLT	PESO/CAJA	PESO/PLT
CONVEX MIX 5 x 25	2" x 10"	54	0,675	33	14,18	483

Piastrella MIX

Pasta Blanca

REVESTIMIENTO
WALL TILE
SUPERFICIE BRILLO
SURFACE BRIGHTNESS

DESTONIFICADO ARMONIOSO
CONTROLLED DESTONIFICATION
BORDES Y SUPERFICIE IRREGULAR
IRREGULAR EDGES AND SURFACE

FORMATOS:
5 x 25 - 2" x 10"
5 x 50 - 2" x 20"
15 x 50 - 6" x 20"



BRILLO · GLOSSY



PIASTRELLA MIX BONE
5 x 25 (G 27) 2" x 10"



PIASTRELLA MIX ASH
5 x 25 (G 27) 2" x 10"



PIASTRELLA MIX ACQUA
5 x 25 (G 27) 2" x 10"



PIASTRELLA MIX OLIVE
5 x 25 (G 27) 2" x 10"



PIASTRELLA MIX CAPUCHINO
5 x 25 (G 27) 2" x 10"



PIASTRELLA MIX ROSE
5 x 25 (G 27) 2" x 10"



PIASTRELLA MIX TURCHESE
5 x 25 (G 27) 2" x 10"



PIASTRELLA MIX GREY
5 x 25 (G 27) 2" x 10"

PIEZAS ESPECIALES · SPECIAL PIECES

Disponibles en todos los colores · Available in all colors

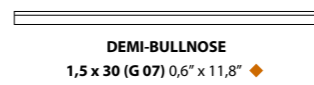

DEMI-BULLNOSE
1,5 x 30 (G 07) 0,6" x 11,8"

PACKING BASES

FORMATO	PULGADAS	PZ/CAJA	M ²	CAJA/PLT	PESO/CAJA	PESO/PLT
5 x 25	2" x 10"	96	1,2	60	19,3	1.172
15 x 50	6" x 20"	16	1,2	60	19,25	1.169
5 x 50	2" x 20"	48	1,2	60	19,06	1.158

PACKING PIEZAS ESPECIALES

FORMATO	PULGADAS	PZ/CAJA	ML	CAJA/PLT	PESO/CAJA	PESO/PLT
DEMI-BULLNOSE 1,5 x 30	0,6" x 11,8"	50	15	120	2,2	276



PIASTRELLA NATURALE
5 x 25 (G 27) 2" x 10"
5 x 50 (G 27) 2" x 20"
15 x 50 (G 39) 6" x 20"

Chic

Pasta
Blanca

White
Body

REVESTIMIENTO
WALL TILE

SIN MANTENIMIENTO
NO MAINTENANCE

SUPERFICIE BRILLO
SURFACE BRIGTHNESS

SUPERFICIE MATE
MATT SURFACE

FORMATO
6,4 x 26 - 2,5" x 10,2"



BRILLO - GLOSSY



MATE - MATT



CHIC CREAM
6,4 x 26 (G 56) 2,5" x 10,2"



CHIC SILVER
6,4 x 26 (G 56) 2,5" x 10,2"



CHIC COTTON
6,4 x 26 (G 56) 2,5" x 10,2"



CHIC COTTON MATT
6,4 x 26 (G 56) 2,5" x 10,2"



CHIC SMOKE
6,4 x 26 (G 56) 2,5" x 10,2"



CHIC ROSE
6,4 x 26 (G 56) 2,5" x 10,2"



CHIC SKY
6,4 x 26 (G 56) 2,5" x 10,2"



CHIC SKY MATT
6,4 x 26 (G 56) 2,5" x 10,2"



CHIC GREY
6,4 x 26 (G 56) 2,5" x 10,2"



CHIC GREY MATT
6,4 x 26 (G 56) 2,5" x 10,2"

PIEZAS ESPECIALES - SPECIAL PIECES

Disponibles en todos los colores - Available in all colors

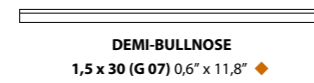

DEMI-BULLNOSE
1,5 x 30 (G 07) 0,6" x 11,8"

PACKING BASES

FORMATO	PULGADAS	PZ/CAJA	M ²	CAJA/PLT	PESO/CAJA	PESO/PLT
6,4 x 26	2,5" x 10,2"	30	0,5	138	7,7	1.077

PACKING PIEZAS ESPECIALES

FORMATO	PULGADAS	PZ/CAJA	ML	CAJA/PLT	PESO/CAJA	PESO/PLT
DEMI-BULLNOSE 1,5 x 30	0,6" x 11,8"	50	15	120	2,2	276

Atelier

Pasta
Blanca

White
Body

REVESTIMIENTO
WALL TILE

BORDES Y SUPERFICIE IRREGULAR
IRREGULAR EDGES AND SURFACE

SUPERFICIE BRILLO
SURFACE BRIGTNES

SUPERFICIE MATE
MATT SURFACE

FORMATOS

5 x 25 - 2" x 10"
7,5 x 30 - 3" x 12"
7,5 x 15 - 3" x 6"
10 x 10 - 4" x 4"
15 x 15 - 6" x 6"



BRILLO - GLOSSY



ATELIER OLD WHITE
5 x 25 (G 59) 2" x 10"



ATELIER ANTIQUE
5 x 25 (G 59) 2" x 10"

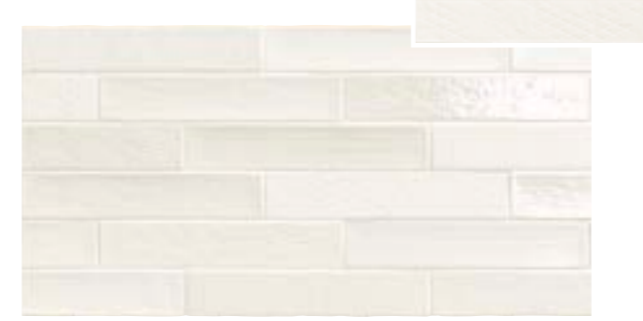

ATELIER COTTON
5 x 25 (G 27) 2" x 10"



ATELIER SILVER
5 x 25 (G 27) 2" x 10"



ATELIER ANTIQUE
10 x 10 (G 59) 4" x 4"



ATELIER ANTIQUE
7,5 x 15 (G 59) 3" x 6"



ATELIER ANTIQUE
7,5 x 30 (G 27) 3" x 12"



ATELIER LLOMA ANTIQUE
15 x 15 (G 59) 6" x 6"



ATELIER OLD ROSE
5 x 25 (G 59) 2" x 10"



ATELIER OLD BLUE
5 x 25 (G 59) 2" x 10"

PIEZAS ESPECIALES - SPECIAL PIECES

Disponibles en todos los colores - Availables in all colors

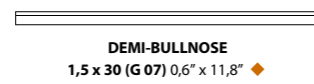

DEMI-BULLNOSE
1,5 x 30 (G 07) 0,6" x 11,8"

PACKING BASES

FORMATO	PULGADAS	PZ/CAJA	M ²	CAJA/PLT	PESO/CAJA	PESO/PLT
5 x 25	2" x 10"	96	1,2	60	19,3	1.172
7,5 x 15	3" x 6"	44	0,5	120	8,5	1.034
7,5 x 30	3" x 12"	22	0,5	120	8,5	1.034
15 x 15	6" x 6"	22	0,5	80	9,2	751
10 x 10	4" x 4"	56	0,56	112	8,32	935

PACKING PIEZAS ESPECIALES

FORMATO	PULGADAS	PZ/CAJA	ML	CAJA/PLT	PESO/CAJA	PESO/PLT
DEMI BULLNOSE 1,5 x 30	0,6" x 11,8"	50	15	120	2,2	276

MATE - MATT

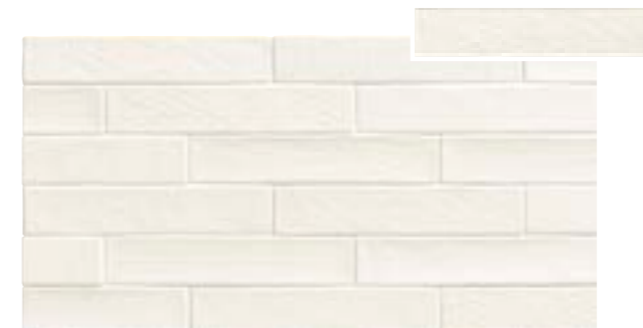





ATELIER COTTON MATT
5 x 25 (G 27) 2" x 10"



ATELIER GREY MATT
5 x 25 (G 27) 2" x 10"

MANHATTAN

Pasta Blanca

-  SUPERFICIE BRILLO
SURFACE BRIGTNES
-  REVESTIMIENTO
WALL TILE
-  SUPERFICIE MATE
MATT SURFACE
-  MODULARIDAD
MODULARITY
-  BORDES Y SUPERFICIE IRREGULAR
IRREGULAR EDGES AND SUFACE



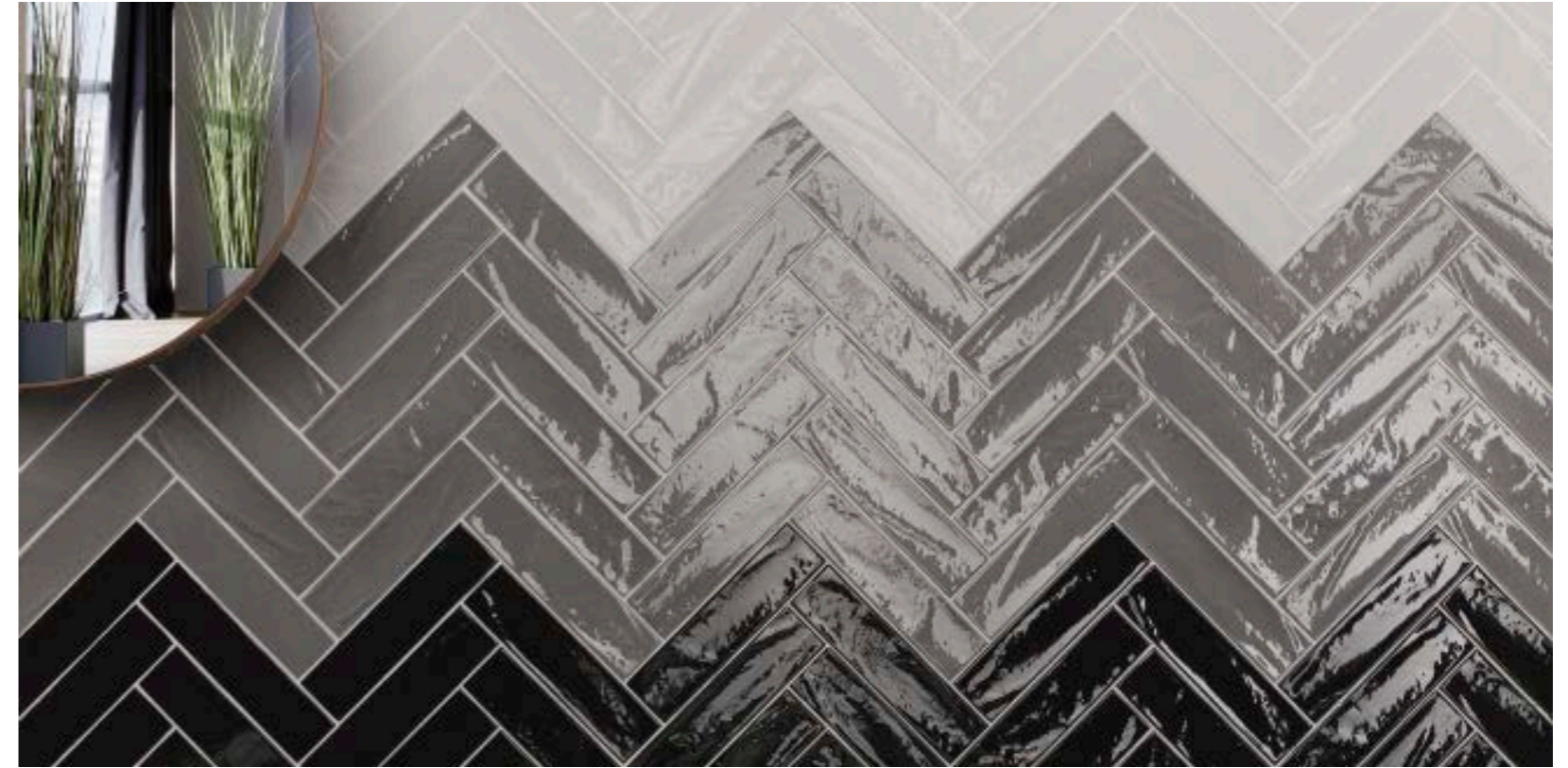





















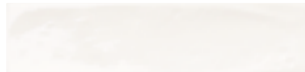















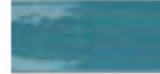

FORMATOS:
7,5 x 15 - 3" x 6"
7,5 x 30 - 3" x 12"



MATE · MATT

			
MANHATTAN MADISON 7,5 x 15 (G 27) 3" x 6" 	MANHATTAN PARK 7,5 x 15 (G 27) 3" x 6" 	MANHATTAN LEXINGTON 7,5 x 15 (G 27) 3" x 6" 	MANHATTAN BROADWAY 7,5 x 15 (G 27) 3" x 6" 
			
MANHATTAN MADISON 7,5 x 30 (G 39) 3" x 12" 	MANHATTAN PARK 7,5 x 30 (G 39) 3" x 12" 	MANHATTAN LEXINGTON 7,5 x 30 (G 39) 3" x 12" 	MANHATTAN BROADWAY 7,5 x 30 (G 39) 3" x 12" 

BRILLO · GLOSSY

						
MANHATTAN 1ST AVE 7,5 x 15 (G 27) 3" x 6" 	MANHATTAN 2ND AVE 7,5 x 15 (G 27) 3" x 6" 	MANHATTAN 5TH AVE 7,5 x 15 (G 27) 3" x 6" 	MANHATTAN 7TH AVE 7,5 x 15 (G 27) 3" x 6" 	MANHATTAN 9TH AVE 7,5 x 15 (G 27) 3" x 6" 	MANHATTAN 10TH AVE 7,5 x 15 (G 27) 3" x 6" 	MANHATTAN 11TH AVE 7,5 x 15 (G 27) 3" x 6" 
						
MANHATTAN 1ST AVE 7,5 x 30 (G 39) 3" x 12" 	MANHATTAN 2ND AVE 7,5 x 30 (G 39) 3" x 12" 	MANHATTAN 5TH AVE 7,5 x 30 (G 39) 3" x 12" 	MANHATTAN 7TH AVE 7,5 x 30 (G 39) 3" x 12" 	MANHATTAN 9TH AVE 7,5 x 30 (G 39) 3" x 12" 	MANHATTAN 10TH AVE 7,5 x 30 (G 39) 3" x 12" 	MANHATTAN 11TH AVE 7,5 x 30 (G 39) 3" x 12" 
						
MANHATTAN 3RD AVE 7,5 x 15 (G 27) 3" x 6" 	MANHATTAN 4TH AVE 7,5 x 15 (G 27) 3" x 6" 	MANHATTAN 6TH AVE 7,5 x 15 (G 27) 3" x 6" 	MANHATTAN 8TH AVE 7,5 x 15 (G 27) 3" x 6" 			
						
MANHATTAN 3RD AVE 7,5 x 30 (G 39) 3" x 12" 	MANHATTAN 4TH AVE 7,5 x 30 (G 39) 3" x 12" 	MANHATTAN 6TH AVE 7,5 x 30 (G 39) 3" x 12" 	MANHATTAN 8TH AVE 7,5 x 30 (G 39) 3" x 12" 			

PIEZAS ESPECIALES · SPECIAL PIECES

Disponibles en todos los colores · Available in all colors







DEMI-BULLNOSE
1,5 x 30 (G 07) 0,6" x 11,8" 

PACKING BASES

FORMATO	PULGADAS	PZ/CAJA	M²	CAJA/PLT	PESO/CAJA	PESO/PLT
7,5 x 30	3" x 12"	22	0,5	120	8,5	1.034
7,5 x 15	3" x 6"	44	0,5	120	8,5	1.034

PACKING PIEZAS ESPECIALES

FORMATO	PULGADAS	PZ/CAJA	ML	CAJA/PLT	PESO/CAJA
1,5 x 30	0,6" x 11,8"	50	15	120	2,2

-  SUPERFICIE BRILLO
SURFACE BRIGHTNESS
-  REVESTIMIENTO
WALL TILE
-  SUPERFICIE MATE
MATT SURFACE
-  MODULARIDAD
MODULARITY
-  BORDES Y SUPERFICIE IRREGULAR
IRREGULAR EDGES AND SURFACE

FORMATOS:
7,5 x 30 - 3" x 12"
7,5 x 15 - 3" x 6"



MATE · MATT

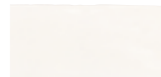

COTSWOLD MATE BIANCO
7,5 x 15 (G 27) 3" x 6" 



COTSWOLD MATE BIANCO
7,5 x 30 (G 39) 3" x 12" 



COTSWOLD MATE NERO
7,5 x 15 (G 27) 3" x 6" 



COTSWOLD MATE NERO
7,5 x 30 (G 39) 3" x 12" 

BRILLO · GLOSSY



COTSWOLD BIANCO
7,5 x 15 (G 27) 3" x 6" 



COTSWOLD BONE
7,5 x 15 (G 27) 3" x 6" 



COTSWOLD BIANCO
7,5 x 30 (G 39) 3" x 12" 



COTSWOLD BONE
7,5 x 30 (G 39) 3" x 12" 



COTSWOLD NERO
7,5 x 15 (G 27) 3" x 6" 



COTSWOLD LATE
7,5 x 15 (G 27) 3" x 6" 



COTSWOLD NERO
7,5 x 30 (G 39) 3" x 12" 



COTSWOLD LATE
7,5 x 30 (G 39) 3" x 12" 



COTSWOLD SAGE
7,5 x 15 (G 27) 3" x 6" 



COTSWOLD ACQUA
7,5 x 15 (G 27) 3" x 6" 



COTSWOLD GREY
7,5 x 15 (G 27) 3" x 6" 



COTSWOLD SAGE
7,5 x 30 (G 39) 3" x 12" 



COTSWOLD ACQUA
7,5 x 30 (G 39) 3" x 12" 



COTSWOLD GREY
7,5 x 30 (G 39) 3" x 12" 



COTSWOLD CAPUCHINO
7,5 x 15 (G 27) 3" x 6" 



COTSWOLD TEAL
7,5 x 15 (G 27) 3" x 6" 



COTSWOLD GRAFITO
7,5 x 15 (G 27) 3" x 6" 



COTSWOLD CAPUCHINO
7,5 x 30 (G 39) 3" x 12" 



COTSWOLD TEAL
7,5 x 30 (G 39) 3" x 12" 



COTSWOLD GRAFITO
7,5 x 30 (G 39) 3" x 12" 

PIEZAS ESPECIALES · SPECIAL PIECES

Disponibles en todos los colores · Available in all colors



PACKING BASES

FORMATO	PULGADAS	PZ/CAJA	M ²	CAJA/PLT	PESO/CAJA	PESO/PLT
7,5 x 30	3" x 12"	22	0,5	120	8,5	1.034
7,5 x 15	3" x 6"	44	0,5	120	8,5	1.034

PACKING PIEZAS ESPECIALES

FORMATO	PULGADAS	PZ/CAJA	ML	CAJA/PLT	PESO/CAJA
ZÓCALO 7,5 x 15	3" x 6"	44	6,6	120	7,6
ZÓCALO 7,5 x 30	3" x 12"	22	6,6	120	10,38
V-CAP 5 x 30	3" x 12"	20	6	84	5
ESQUINA V-CAP 3 x 5	1,2" x 2"	25	1,25	56	0,73
DEMI-BULLNOSE 1,5 x 30	0,6" x 11,8"	50	15	120	2,2



ZOCALO/BULLNOSE COTSWOLD
7,5 x 30 (G 10) 3" x 12" 
7,5 x 15 (G 06) 3" x 6" 

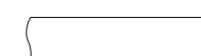

V-CAP COTSWOLD
5 x 30 (G 31) 3" x 12" 



ESQUINA V-CAP COTSWOLD
3 x 5 (G 10) 1,2" x 2" 



DEMI-BULLNOSE
1,5 x 30 (G 07) 0,6" x 11,8" 

NORDIK

Comfort floor

EVOLUTIO
EXTRUDED PORCELAIN TILE

RESISTE LA FLEXIÓN
32 N/mm2

RESISTE EL DESGASTE
PEI (II - IV)

RESISTE EL RAYADO
MOHS - 4

ANTIDESLIZANTE
Class II

MANCHAS
Class 5 - Class A

ABSORCIÓN
0,3%

DILATACIÓN
6,6° 10°/°C

FORMATOS

7 x 36 - 3" x 14"
4 x 36 - 1,5" x 14"

PE GRES EXTRUS. PORCELÁNICO
PAVIMENTO DE INTERIOR
REVESTIMIENTO
SUPERFICIE MATE
RES. A ÁCIDOS Y BASES
RES. A LA HELADA
DESTONIFICADO ARMONIOSO
SIN MANTENIMIENTO



COLORES · COLORS

Comfort floor ▶ Class II

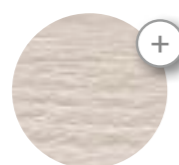

NORDIK ROPE
7 x 36 (G 39) 3" x 14" ^{m²}
4 x 36 (G 59) 1,5" x 14" ^{m²}

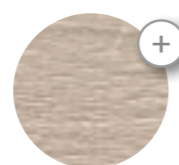

NORDIK TAN
7 x 36 (G 39) 3" x 14" ^{m²}
4 x 36 (G 59) 1,5" x 14" ^{m²}

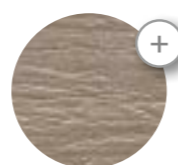

NORDIK CHESNUT
7 x 36 (G 39) 3" x 14" ^{m²}
4 x 36 (G 59) 1,5" x 14" ^{m²}

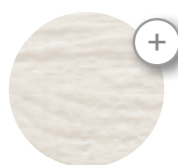

NORDIK FIORD
7 x 36 (G 39) 3" x 14" ^{m²}
4 x 36 (G 59) 1,5" x 14" ^{m²}



NORDIK ALUMINIUM
7 x 36 (G 39) 3" x 14" ^{m²}
4 x 36 (G 59) 1,5" x 14" ^{m²}

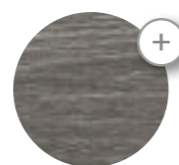

NORDIK SMOKE
7 x 36 (G 39) 3" x 14" ^{m²}
4 x 36 (G 59) 1,5" x 14" ^{m²}

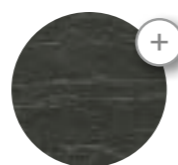

NORDIK GRAPHITE
7 x 36 (G 39) 3" x 14" ^{m²}
4 x 36 (G 59) 1,5" x 14" ^{m²}



PACKING BASES

FORMATO	PULGADAS	PZ/CAJA	M²	CAJA/PLT	PESO/CAJA	PESO/PLT
7 x 36	3" x 14"	40	1	72	22,94	1,675
4 x 36	1,5" x 14"	60	0,86	72	22	1,555

Regles

EVOLUTION
EXTRUDED PORCELAIN TILE

REVESTIMIENTO
WALL TILE
SUPERFICIE BRILLO
SURFACE BRIGHTNESS

Pavimento de interior
indoor floor tiles
VOLUMEN
VOLUME

FORMATOS:
7,2 x 22,2 - 3" x 8,5"
15 x 25 - 6" x 10"

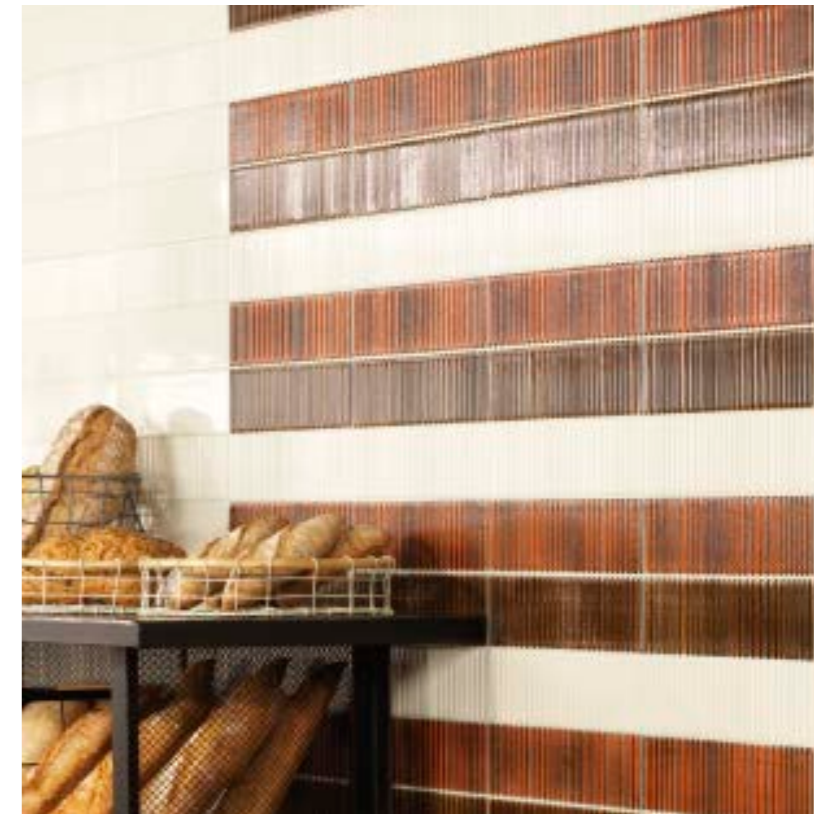

COLORES · COLORS

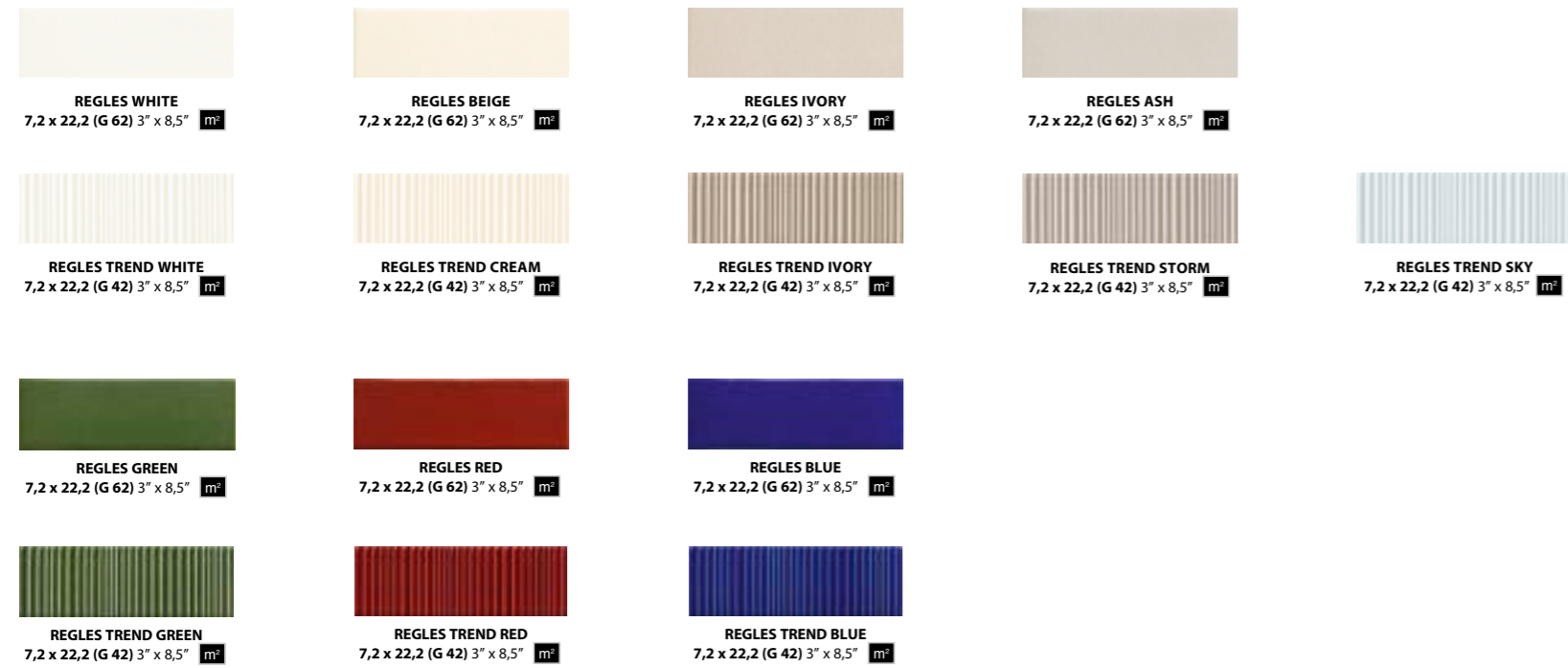

PIEZAS ESPECIALES · SPECIAL PIECES

Disponibles en todos los colores · Available in all colors

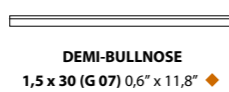

COLORES TOP · COLORS TOP

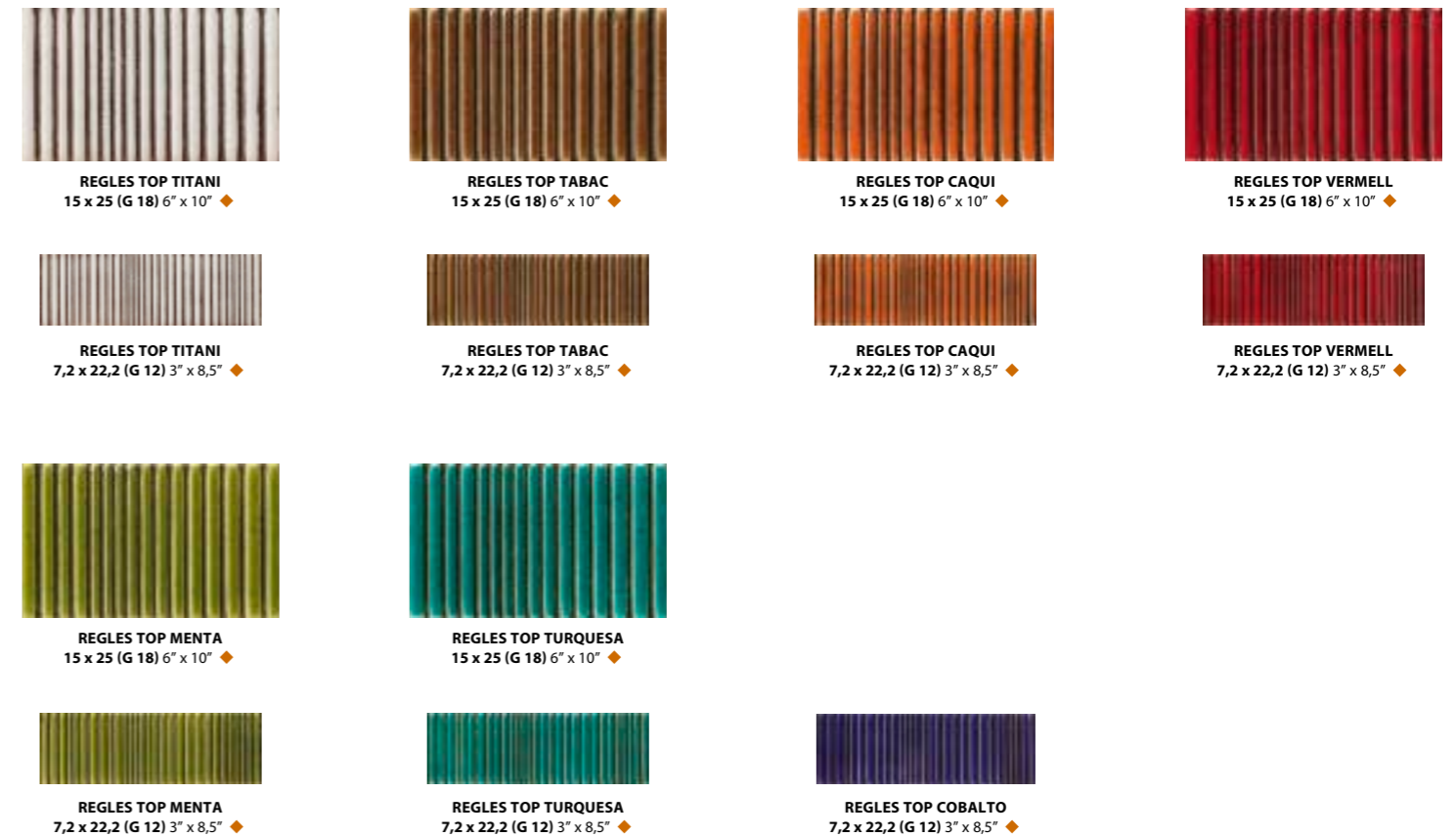

PACKING BASES

FORMATO	PULGADAS	PZ/CAJA	M²/CAJA	ML	CAJA/PLT	PESO/CAJA	PESO/PLT
REGLES 15 x 25	6" x 10"	20	0,75	5	60	17,4	1.058
REGLES 7,2 x 22,2	3" x 8,5"	50	0,799	11,1	60	16,60	1.011

PACKING PIEZAS ESPECIALES

FORMATO	PULGADAS	PZ/CAJA	ML	CAJA/PLT	PESO/CAJA	PESO/PLT
DEMI-BULLNOSE 1,5 x 30	0,6" x 11,8"	50	15	120	2,2	276

LONDON

Pasta Blanca

-  REVESTIMIENTO WALL TILE
-  SUPERFICIE BRILLO SURFACE BRIGHTNESS
-  SUPERFICIE MATE MATT SURFACE

FORMATO:
7,2 x 22,2 - 3" x 8,7"



MATE · MATT 



LONDON WHITE MATT
7,2 x 22,2 (G 58) 3" x 8,7" m

BRILLO · GLOSSY 

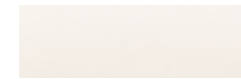

LONDON WHITE
7,2 x 22,2 (G 58) 3" x 8,7" m

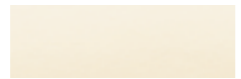

LONDON BONE
7,2 x 22,2 (G 58) 3" x 8,7" m



LONDON SAGE
7,2 x 22,2 (G 58) 3" x 8,7" m



LONDON CEMENT
7,2 x 22,2 (G 58) 3" x 8,7" m



LONDON RAIN
7,2 x 22,2 (G 58) 3" x 8,7" m



LONDON COAL
7,2 x 22,2 (G 58) 3" x 8,7" m



LONDON OLIVE
7,2 x 22,2 (G 58) 3" x 8,7" m



LONDON JEANS
7,2 x 22,2 (G 58) 3" x 8,7" m



LONDON MINT
7,2 x 22,2 (G 58) 3" x 8,7" m

PIEZAS ESPECIALES · SPECIAL PIECES

Disponible en todos los colores
Available in all colours



DEMI-BULLNOSE
1,5 x 30 (G 07) 0,6" x 11,8" ◆



ZÓCALO
7,2 x 22,2 (G 10) 3" x 8,7" ◆

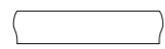

LONDON V-CAP
5 x 22,2 (G 13) 2" x 8,7" ◆

PACKING BASES

FORMATO	PULGADAS	PZ/CAJA	M ²	ML	CAJA/PLT	PESO/CAJA	PESO/PLT
7,2 x 22,2	3" x 8,7"	30	0,48	-	120	7,66	935

PACKING PIEZAS ESPECIALES

FORMATO	PULGADAS	PZ/CAJA	ML	CAJA/PLT	PESO/CAJA	PESO/PLT
DEMI-BULLNOSE 1,5 x 30	0,6" x 11,8"	50	15	120	2,2	276
ZÓCALO 7,2 x 22,2	3" x 8,7"	30	6,66	120	7,66	935
V-CAP 5 x 22,2	2" x 8,7"	20	4,5	-	4,6	-



POOL

PORCELÁNICO
PORCELAIN TILE

AntiSlip

fine RESISTANCE

Comfort floor

SUPERFICIE MATE
MATT SURFACE

SUPERFICIE BRILLO
SURFACE BRIGTNES

REVESTIMIENTO
WALL TILE

RESIST. A LA HELADA
FROST PROOF

SIN MANTENIMIENTO
NO MAINTENANCE

FORMATO

10 x 10 - 4" x 4"
ENM. 30,5 x 30,5 - 11,8" x 11,8"



PIEZAS ESPECIALES - SPECIAL PIECES

Disponibles en todos los colores - Available in all colors

- 1 COMP. INT. CUBRECANTO 3 x 3 (G 16) 1" x 1"
- 2 CUBRECANTO 3 x 20 x 3 (G 07) 1" x 8" x 1"
- 3 COMP. EXT. CUBRECANTO 3 x 3 (G 12) 1" x 1"
- 4 COMP. EXT. MEDIA CAÑA 3 x 3 (G 16) 1" x 1"
- 5 MEDIA CAÑA INT. 3 x 20 x 3 (G 07) 1" x 8" x 1"
- 6 COMP. INT. MEDIA CAÑA 3 x 3 (G 12) 1" x 1"

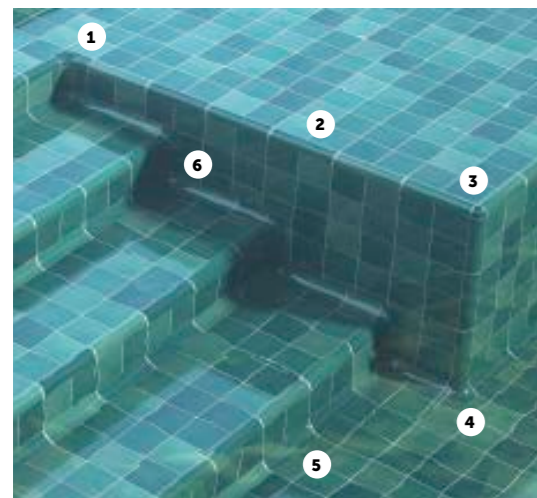

BRILLO - BRIGTNES



POOL PORC. LUZ
10 x 10 (G 27) 4" x 4"
ENM. 30,5 x 30,5 (G 42) 11,8" x 11,8"



POOL PORC. CLOUD
10 x 10 (G 27) 4" x 4"
ENM. 30,5 x 30,5 (G 42) 11,8" x 11,8"



POOL PORC. IRON
10 x 10 (G 27) 4" x 4"
ENM. 30,5 x 30,5 (G 42) 11,8" x 11,8"



POOL PORC. EMERALD
10 x 10 (G 27) 4" x 4"
ENM. 30,5 x 30,5 (G 42) 11,8" x 11,8"

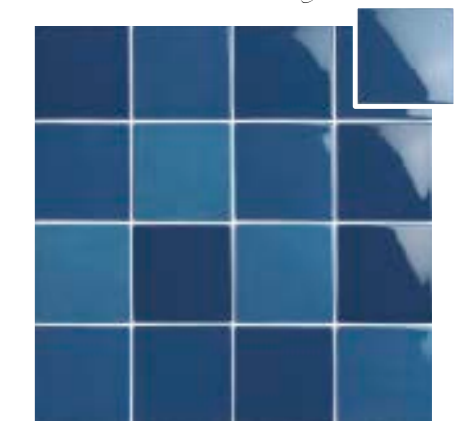

POOL PORC. INDIGO
10 x 10 (G 27) 4" x 4"
ENM. 30,5 x 30,5 (G 42) 11,8" x 11,8"

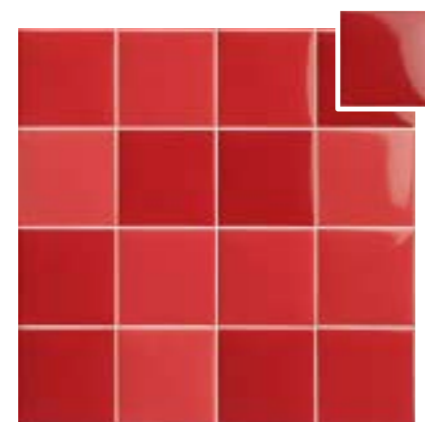

POOL PORC. ROJO
10 x 10 (G 27) 4" x 4"
ENM. 30,5 x 30,5 (G 42) 11,8" x 11,8"

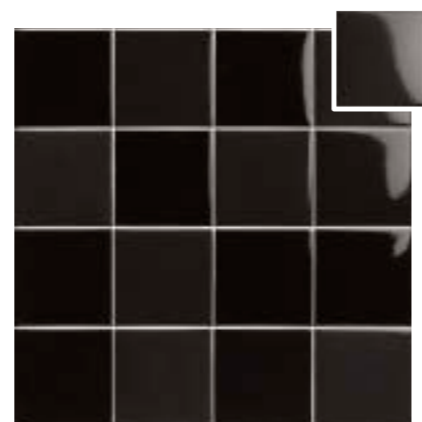

POOL PORC. NEGRO
10 x 10 (G 27) 4" x 4"
ENM. 30,5 x 30,5 (G 42) 11,8" x 11,8"

MATE - MATT

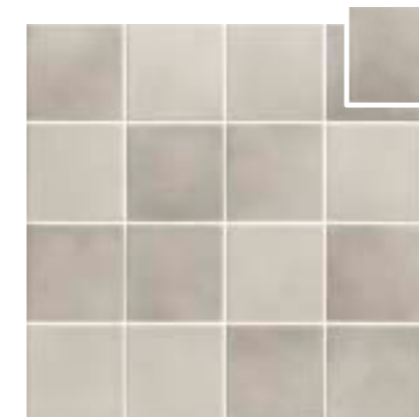

POOL PORC. IRON ANTISLIP
10 x 10 (G 78) 4" x 4"
ENM. 30,5 x 30,5 (G 64) 11,8" x 11,8"

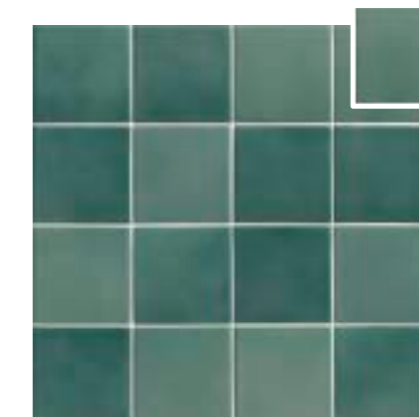

POOL PORC. EMERALD ANTISLIP
10 x 10 (G 78) 4" x 4"
ENM. 30,5 x 30,5 (G 64) 11,8" x 11,8"

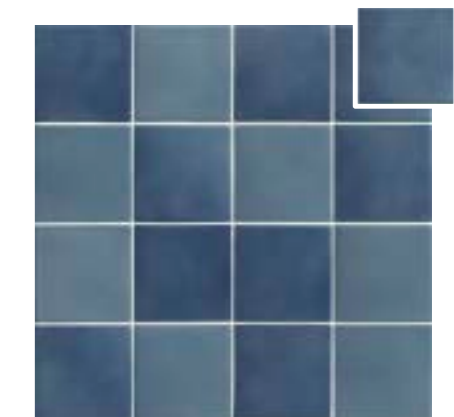

POOL PORC. INDIGO ANTISLIP
10 x 10 (G 78) 4" x 4"
ENM. 30,5 x 30,5 (G 64) 11,8" x 11,8"

PACKING BASES

FORMATO	PULGADAS	PZ/CAJA	M ²	CAJA/PLT	PESO/CAJA	PESO/PLT
10 x 10	4" x 4"	50	0,5	120	10,5	1.275
ENM. 30,5 x 30,5	11,8" x 11,8"	11	1,02	60	22	1335

PACKING PIEZAS ESPECIALES

FORMATO	PULGADAS	PZ/CAJA	ML	CAJA/PLT	PESO/CAJA	PESO/PLT
MEDIA CAÑA INT. 3 x 20 x 3	1" x 8" x 1"	36	7,2	196	1,98	405
COMP. INT. MEDIA CAÑA 3 x 3	1" x 1"	100	3	196	0,85	182
COMP. EXT. MEDIA CAÑA 3 x 3	1" x 1"	100	3	196	1,6	310

PACKING PIEZAS ESPECIALES

FORMATO	PULGADAS	PZ/CAJA	ML	CAJA/PLT	PESO/CAJA	PESO/PLT
CUBRECANTO 3 x 20 x 3	1" x 8" x 1"	36	7,2	196	1,98	405
COMP. INT. CUBRECANTO 3 x 3	1" x 1"	100	3	196	1,6	310
COMP. EXT. CUBRECANTO 3 x 3	1" x 1"	100	3	196	0,85	182

STOWMIX

Pasta Blanca

REVESTIMIENTO
WALL TILE

SUPERFICIE BRILLO
SURFACE BRIGTNES

BORDES Y SUPERFICIE IRREGULAR
IRREGULAR EDGES AND SUFACE

FORMATOS:
10 x 10 - 4" x 4"



COLORES DESTONIFICADOS · DESTONIFIED COLORS



STOW MIX ACQUA
10 x 10 (G 27) 4" x 4" m²

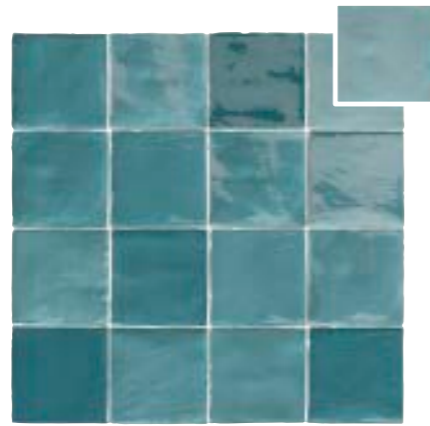

STOW MIX TURCHESE
10 x 10 (G 27) 4" x 4" m²

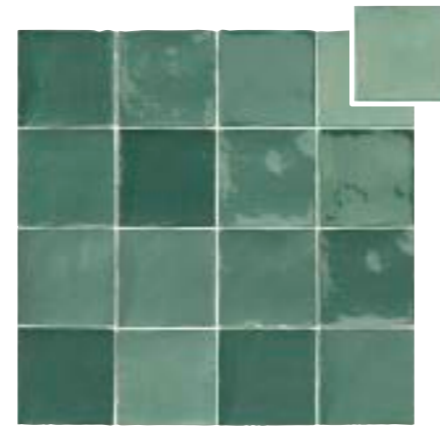

STOW MIX OLIVE
10 x 10 (G 27) 4" x 4" m²



STOW MIX GREY
10 x 10 (G 27) 4" x 4" m²



STOW MIX GRAFFITO
10 x 10 (G 27) 4" x 4" m²

PIEZAS ESPECIALES · SPECIAL PIECES

Disponibles en todos los colores · Available in all colors



DEMI-BULLNOSE
1,5 x 30 (G 07) 0,6" x 11,8" ◆

COLORES · COLORS



STOW BIANCO
10 x 10 (G 27) 4" x 4" m²

STOW BIANCO
20 x 20 (G 56) 8" x 8" m²

STOW BIANCO
20 x 60 (G 27) 8" x 24" m²



STOW ASH
10 x 10 (G 27) 4" x 4" m²

STOW ASH
20 x 20 (G 56) 8" x 8" m²

STOW ASH
20 x 60 (G 27) 8" x 24" m²



STOW GRAFITO
10 x 10 (G 27) 4" x 4" m²

STOW GRAFITO
20 x 20 (G 56) 8" x 8" m²

STOW GRAFITO
20 x 60 (G 27) 8" x 24" m²

PACKING BASES

FORMATO	PULGADAS	PZ/CAJA	M ²	CAJA/PLT	PESO/CAJA	PESO/PLT
10 x 10	4" x 4"	56	0,56	112	8,44	960

PACKING PIEZAS ESPECIALES

FORMATO	PULGADAS	PZ/CAJA	ML	CAJA/PLT	PESO/CAJA	PESO/PLT
DEMI-BULLNOSE 1,5 x 30	0,6" x 11,8"	50	15	120	2,2	276

STOW

Pasta Blanca

REVESTIMIENTO
WALL TILE

BORDES Y SUPERFICIE IRREGULAR
IRREGULAR EDGES AND SURFACE

SUPERFICIE BRILLO
SURFACE BRIGTNES

MODULAR
MODULARITY

VOLUMEN
VOLUME

FORMATOS:
10 x 10 - 4" x 4"
20 x 20 - 8" x 8"
20 x 60 - 8" x 24"
3D HEX. ENM. 34 x 32,6 - 13,3" x 12,7"



COLORES · COLORS



STOW BIANCO
20 x 60 (G 27) 8" x 24" m



STOW BIANCO
20 x 20 (G 56) 8" x 8" m



STOW BIANCO
10 x 10 (G 27) 4" x 4" m



STOW ASH
20 x 60 (G 27) 8" x 24" m



STOW ASH
20 x 20 (G 56) 8" x 8" m



STOW ASH
10 x 10 (G 27) 4" x 4" m



STOW GRAFITO
20 x 60 (G 27) 8" x 24" m



STOW GRAFITO
20 x 20 (G 56) 8" x 8" m



STOW GRAFITO
10 x 10 (G 27) 4" x 4" m



3D HEX. BIANCO ENM.
34 x 32,6 (G 54) 13,3" x 12,7" m

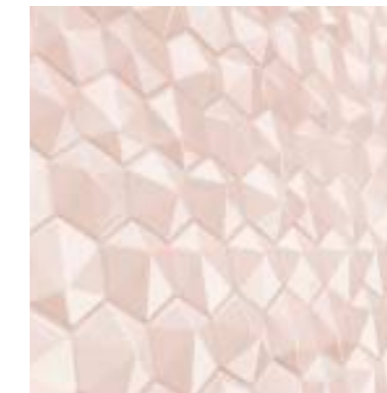

3D HEX. ROSA MIX ENM.
34 x 32,6 (G 54) 13,3" x 12,7" m



3D HEX. TURQUESA MIX ENM.
34 x 32,6 (G 54) 13,3" x 12,7" m



3D HEX. AMARILLO MIX ENM.
34 x 32,6 (G 54) 13,3" x 12,7" m



3D HEX. VERDE MIX ENM.
34 x 32,6 (G 54) 13,3" x 12,7" m

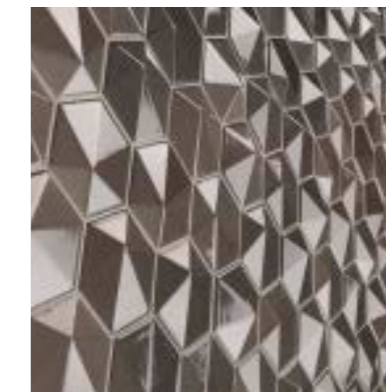

3D HEX. GRAFITO MIX ENM.
34 x 32,6 (G 54) 13,3" x 12,7" m

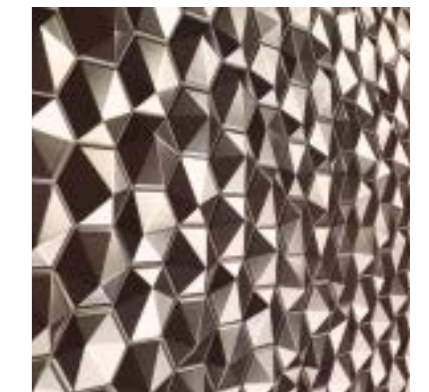

3D HEX. METALICO ENM.
34 x 32,6 (G 54) 13,3" x 12,7" m

STOW DECOR

Disponibles en todos los colores · Available in all colors

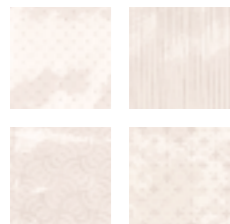

STOW BIANCO DECOR
10 x 10 (G 62) 4" x 4" m



4 TEXTURAS DIFERENTES · Se suministran mezclados
4 DIFFERENT TEXTURES · Supplied mixed

PIEZAS ESPECIALES · SPECIAL PIECES

Disponibles en todos los colores · Available in all colors

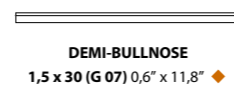

DEMI-BULLNOSE
1,5 x 30 (G 07) 0,6" x 11,8" ♦

PACKING BASES

FORMATO	PULGADAS	PZ/CAJA	M²	CAJA/PLT	PESO/CAJA	PESO/PLT
10 x 10	4" x 4"	56	0,56	112	8,44	960
20 x 20	8" x 8"	28	1,12	60	16,65	1014
20 x 60	8" x 24"	8	0,96	32	15	495
ENM. 34 x 32,6	13,3" x 12,7"	8	0,89	36	14,82	549

PACKING PIEZAS ESPECIALES

FORMATO	PULGADAS	PZ/CAJA	ML	CAJA/PLT	PESO/CAJA	PESO/PLT
DEMI-BULLNOSE 1,5 x 30	0,6" x 11,8"	50	15	120	2,2	276

MURETTO

PORCELÁNICO
PORCELAIN TILE

PAV. DE INTERIOR
INDOOR FLOOR TILE

SUPERFICIE BRILLO
SURFACE BRIGTNES

REVESTIMIENTO
WALL TILE

BORDES Y SUPERFICIE IRREGULAR
IRREGULAR EDGES AND SUFACE

FORMATOS:
5 x 25 - 2" x 10"



COLORES · COLORS



MURETTO BIANCO
5 x 25 (G 78) 2" x 10" m



MURETTO GRIGIO
5 x 25 (G 78) 2" x 10" m



MURETTO ARGENTO
5 x 25 (G 72) 2" x 10" m



MURETTO TOSTATO
5 x 25 (G 78) 2" x 10" m



MURETTO NOCCIOLA
5 x 25 (G 78) 2" x 10" m



MURETTO ORO
5 x 25 (G 72) 2" x 10" m

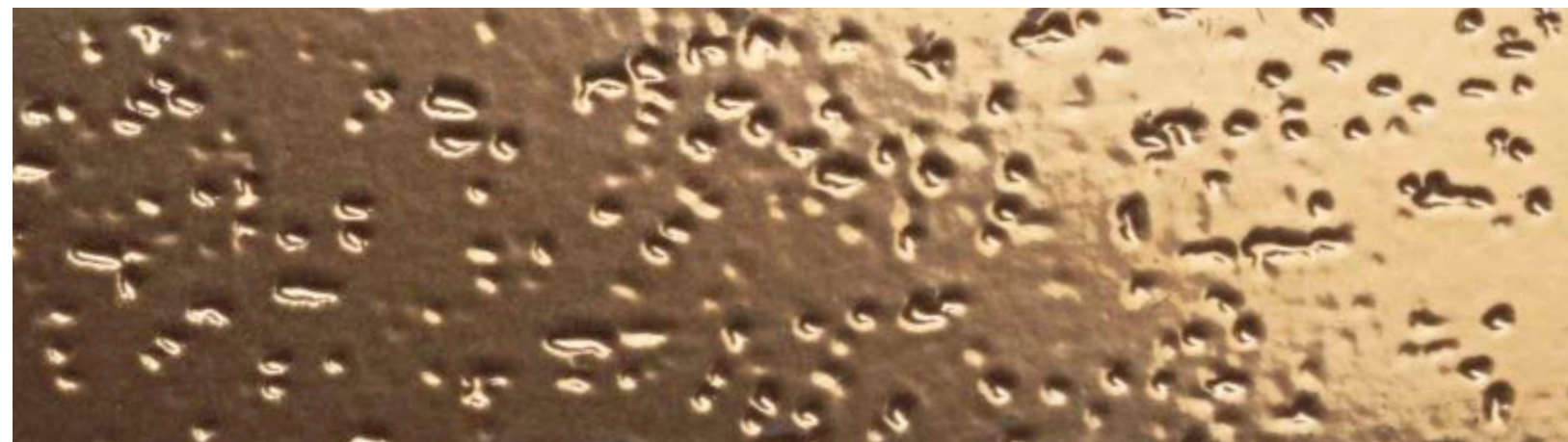

PACKING BASES

FORMATO	PULGADAS	PZ/CAJA	M ²	CAJA/PLT	PESO/CAJA	PESO/PLT
5 x 25	2" x 10"	69	0,826	60	18,18	1,106

CAPRI

EVOLUTION
EXTRUDED PORCELAIN TILE

PAV. DE INTERIOR
INDOOR FLOOR TILE

REVESTIMIENTO
WALL TILE

SUPERFICIE BRILLO
SURFACE BRIGTNES

SIN MANTENIMIENTO
NO MAINTENANCE

RES. A ÁCIDOS Y BASES
RES. TO ACIDS AND BASES

RES. A LA HELADA
FROST PROOF

DESTONIFICADO ARMONIOSO
CONTROLLED DESTONIFICATION

FORMATOS:
6,5 x 25 - 2,5" x 10"
TRAB. ENM. 25 x 50 - 10" x 20"
18 x 20,5 - 7" x 8"

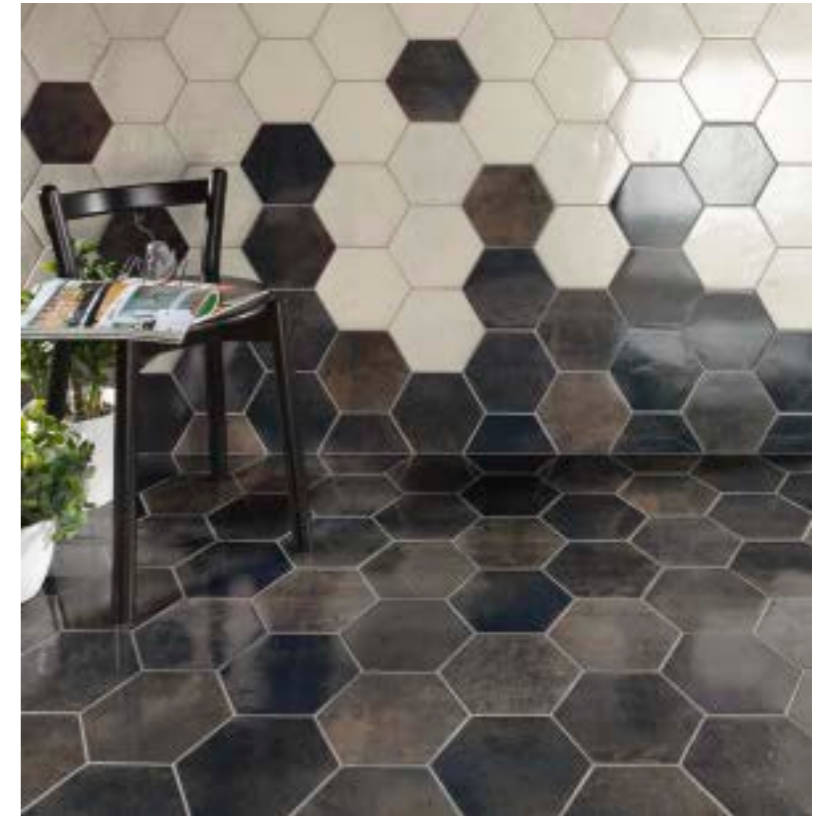
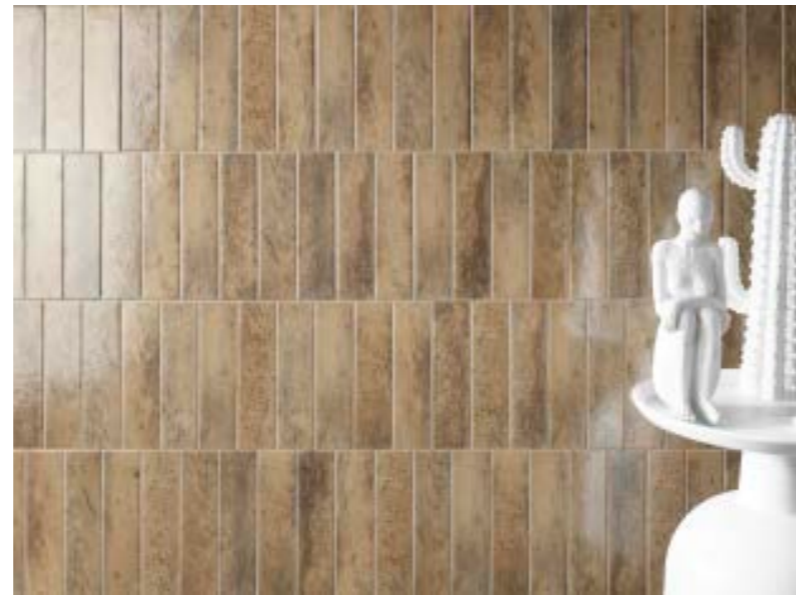

COLORES · COLORS



CAPRI NEVE
6,5 x 25 (G 56) 2,5" x 10"
TRAB. ENM. 25 x 50 (G 60) 10" x 20"



CAPRI FUMO
6,5 x 25 (G 56) 2,5" x 10"
TRAB. ENM. 25 x 50 (G 60) 10" x 20"



CAPRI TERRA
6,5 x 25 (G 56) 2,5" x 10"
TRAB. ENM. 25 x 50 (G 60) 10" x 20"



CAPRI OLIVA
6,5 x 25 (G 56) 2,5" x 10"
TRAB. ENM. 25 x 50 (G 60) 10" x 20"



CAPRI INDIGO
6,5 x 25 (G 56) 2,5" x 10"
TRAB. ENM. 25 x 50 (G 60) 10" x 20"



CAPRI NERO
6,5 x 25 (G 56) 2,5" x 10"
TRAB. ENM. 25 x 50 (G 60) 10" x 20"



CAPRI NEVE HEX.
18 x 20,5 (G 39) 7" x 8"



CAPRI FUMO HEX.
18 x 20,5 (G 39) 7" x 8"



CAPRI TERRA HEX.
18 x 20,5 (G 39) 7" x 8"



CAPRI OLIVA HEX.
18 x 20,5 (G 39) 7" x 8"



CAPRI INDIGO HEX.
18 x 20,5 (G 39) 7" x 8"

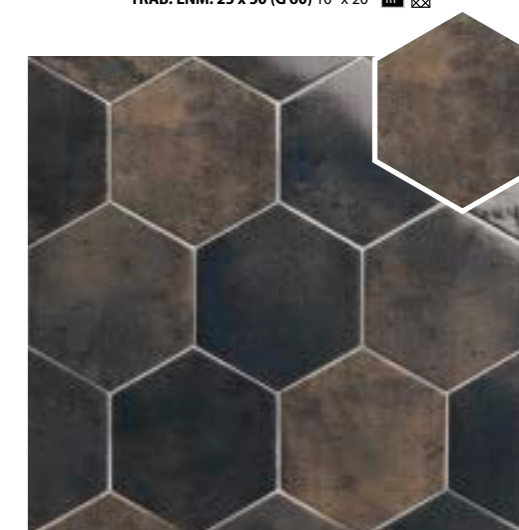

CAPRI NERO HEX.
18 x 20,5 (G 39) 7" x 8"

PACKING BASES

FORMATO	PULGADAS	PZ/CAJA	M²	CAJA/PLT	PESO/CAJA	PESO/PLT
6,5 x 25	2,5" x 10"	27	0,439	176	9	1.423
TRAB. 25 x 50	10" x 20"	6	0,75	40	14,2	583
HEX. 18 x 20,5	7" x 8"	36	1	48	21	1.008

PACKING PIEZAS ESPECIALES

FORMATO	PULGADAS	PZ/CAJA	ML	CAJA/PLT	PESO/CAJA	PESO/PLT
DEMI-BULLNOSE 1,5 x 30	0,6" x 11,8"	50	15	120	2,2	276

PIEZAS ESPECIALES · SPECIAL PIECES

Disponibles en todos los colores · Available in all colors

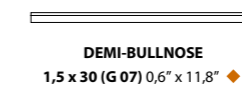

frame

EVOLUTION
EXTRUDED PORCELAIN TILE

PE GRES EXTRUSIONADO PORCELÁNICO
PORCELAIN EXTRUDED TILE

SUPERFICIE BRILLO
SURFACE BRIGTNESS

RESIST. A LA HELADA
FROST PROOF

BORDES Y SUPERFICIE IRREGULAR
IRREGULAR EDGES AND SUFACE

SIN MANTENIMIENTO
NO MAINTENANCE

FORMATOS:
15 x 30 - 6" x 12"



COLORES · COLORS



FRAME WHITE
15 x 30 (G 25) 6" x 12" m



FRAME BEIGE
15 x 30 (G 25) 6" x 12" m



FRAME SAGE
15 x 30 (G 25) 6" x 12" m



FRAME BLUE
15 x 30 (G 25) 6" x 12" m

PACKING BASES

FORMATO	PULGADAS	PZ/CAJA	M²	CAJA/PLT	PESO/CAJA	PESO/PLT
15 x 30	6" x 12"	22	1	52	19,90	1,850

TEMPO

EVOLUTION
EXTRUDED PORCELAIN TILE

RESISTE LA FLEXIÓN	RESISTE EL DESGASTE	RESISTE EL RAYADO	ANTIDESLIZANTE	MANCHAS	ABSORCIÓN	DILATACIÓN
32 N/m2	PEI (II - V)	MOHS-7	Class I - R9	Class S - Class A	<0,3%	5,7" 10" / °C

PAV. DE INTERIOR INDOOR FLOOR TILE	REVESTIMIENTO WALL TILE	SUPERFICIE BRILLO SURFACE BRIGTHNESS	SIN MANTENIMIENTO NO MAINTENANCE	RES. A ÁCIDOS Y BASES RES. TO ACIDS AND BASES	RES. A LA HELADA FROST PROOF	DESTONIFICADO ARMONIOSO CONTROLLED DESTONIFICATION



TEMPO SAND 11 x 11 (G 58) 4,3" x 4,3" m ²	TEMPO FOSSIL 11 x 11 (G 58) 4,3" x 4,3" m ²	TEMPO MOSS 11 x 11 (G 58) 4,3" x 4,3" m ²	TEMPO ATLANTIC 11 x 11 (G 58) 4,3" x 4,3" m ²
TEMPO SAND 11 x 22,5 (G 58) 4,3" x 8,8" m ²	TEMPO FOSSIL 11 x 22,5 (G 58) 4,3" x 8,8" m ²	TEMPO MOSS 11 x 22,5 (G 58) 4,3" x 8,8" m ²	TEMPO ATLANTIC 11 x 22,5 (G 58) 4,3" x 8,8" m ²
TEMPO SAND HEX. 18 x 20,5 (G 39) 7" x 8" m ²	TEMPO FOSSIL HEX. 18 x 20,5 (G 39) 7" x 8" m ²	TEMPO FABRIC HEX. 18 x 20,5 (G 55) 7" x 8" m ²	TEMPO MOSS HEX. 18 x 20,5 (G 39) 7" x 8" m ²
TEMPO ATLANTIC HEX. 18 x 20,5 (G 39) 7" x 8" m ²			

TEMPO SAND 7 x 45 (G 27) 3" x 17,7" m ²	TEMPO FOSSIL 7 x 45 (G 27) 3" x 17,7" m ²	TEMPO MOSS 7 x 45 (G 27) 3" x 17,7" m ²	TEMPO ATLANTIC 7 x 45 (G 27) 3" x 17,7" m ²
TEMPO SAND 22,5 x 45 (G 25) 8,8" x 17,7" m ²	TEMPO FOSSIL 22,5 x 45 (G 25) 8,8" x 17,7" m ²	TEMPO MOSS 22,5 x 45 (G 25) 8,8" x 17,7" m ²	TEMPO ATLANTIC 22,5 x 45 (G 25) 8,8" x 17,7" m ²

TEMPO RICE 11 x 11 (G 58) 4,3" x 4,3" m ²	TEMPO DROP RICE 11 x 11 (G 56) 4,3" x 4,3" m ²	TEMPO CAVIAR 11 x 11 (G 58) 4,3" x 4,3" m ²	
TEMPO RICE 11 x 22,5 (G 58) 4,3" x 8,8" m ²	TEMPO SACK RICE 11 x 22,5 (G 56) 4,3" x 8,8" m ²	TEMPO CAVIAR 11 x 22,5 (G 58) 4,3" x 8,8" m ²	
TEMPO RICE HEX. 18 x 20,5 (G 39) 7" x 8" m ²	TEMPO BOND RICE HEX. 18 x 20,5 (G 55) 7" x 8" m ²	TEMPO CAVIAR HEX. 18 x 20,5 (G 39) 7" x 8" m ²	
TEMPO LINK RICE 7 x 45 (G 59) 3" x 17,7" m ²	TEMPO LINK CAVIAR 7 x 45 (G 59) 3" x 17,7" m ²		
TEMPO RICE 7 x 45 (G 27) 3" x 17,7" m ²	TEMPO CAVIAR 7 x 45 (G 27) 3" x 17,7" m ²		
TEMPO RICE 22,5 x 45 (G 25) 8,8" x 17,7" m ²	TEMPO CAVIAR 22,5 x 45 (G 25) 8,8" x 17,7" m ²		

PIEZAS ESPECIALES - SPECIAL PIECES
Disponibile en todos los colores - Available in all colors

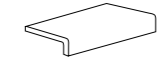

VIERTEAGUAS
15 x 22,5/4 (G 10) 5,9" x 8,8" m²



DEMI-BULLNOSE
1,5 x 30 (G 07) 0,6" x 11,8" m²

DECORACIÓN - DECORATION

11 x 11 (G 56) 4,3" x 4,3" m² Escala reducida



TEMPO MOTIF RICE TEMPO INCLINE RICE TEMPO PATTERN SAND



TEMPO OLD MOSS TEMPO OLD ATLANTIC TEMPO LINES ATLANTIC TEMPO LINES CAVIAR

22,5 x 22,5 (G 57) 8,8" x 8,8" m² Escala reducida

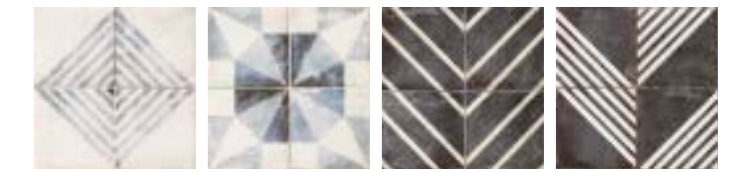

TEMPO ROADS ATLANTIC TEMPO TANGRAM ATLANTIC TEMPO PATTERN CAVIAR TEMPO ROADS CAVIAR

PACKING BASES

FORMATO	PULGADAS	PZ/CAJA	M ²	CAJA/PLT	PESO/CAJA	PESO/PLT
11 x 11	4,3" x 4,3"	40	0,5	144	10,15	1491
11 x 22,5	4,3" x 8,8"	20	0,5	144	10,3	1498

PACKING BASES

FORMATO	PULGADAS	PZ/CAJA	M ²	CAJA/PLT	PESO/CAJA	PESO/PLT
22,5 x 45	8,8" x 17,7"	10	1,01	72	21,1	1535
HEX. 18 x 20,5	7" x 8"	36	1	48	21	1025
7 x 45	3" x 17,7"	32	1	60	21,4	1300

PACKING PIEZAS ESPECIALES

FORMATO	PULGADAS	PZ/CAJA	ML	CAJA/PLT	PESO/CAJA	PESO/PLT
VIERTEAGUAS 15 x 22,5/4	5,9" x 8,8"	14	3,15	48	15,08	739
DEMI BULLNOSE 1,5 x 30	0,6" x 11,8"	50	15	120	2,2	276

TEMPO

EVOLUTION
EXTRUDED PORCELAIN TILE

RESISTE LA FLEXIÓN 32 N/m2	RESISTE EL DESGASTE PEI (II - V)	RESISTE EL RAYADO MOHS-7	ANTIDESLIZANTE Class I - R9	MANCHAS Class 5 - Class A	ABSORCIÓN <0,3%	DILATACIÓN 5,7" 10" / °C

PAV. DE INTERIOR INDOOR FLOOR TILE	REVESTIMIENTO WALL TILE	SUPERFICIE BRILLO SURFACE BRIGHTNESS	SIN MANTENIMIENTO NO MAINTENANCE	RES. A ÁCIDOS Y BASES RES. TO ACIDS AND BASES	RES. A LA HELADA FROST PROOF	DESTONIFICADO ARMONIOSO CONTROLLED DESTONIFICATION



TEMPO OLD ATLANTIC
11 x 11 (G 56) 4,3" x 4,3"

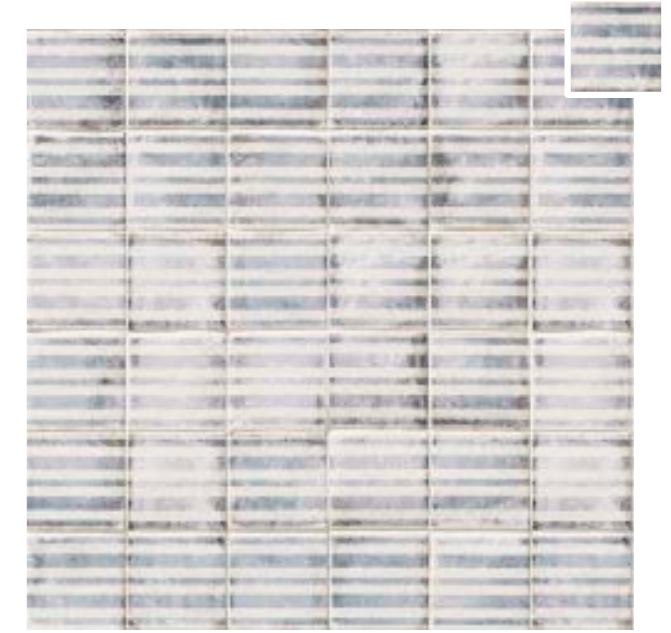

TEMPO LINES ATLANTIC
11 x 11 (G 56) 4,3" x 4,3"



TEMPO OLD MOSS
11 x 11 (G 56) 4,3" x 4,3"



TEMPO LINES CAVIAR
11 x 11 (G 56) 4,3" x 4,3"

DECORACIÓN · DECORATION

La serie TEMPO combina con las bases de la serie TEMPO pág. 156 - 157
TEMPO combines with TEMPO collection, pág. 156 - 157



TEMPO INCLINE RICE
11 x 11 (G 56) 4,3" x 4,3"



TEMPO MOTIF RICE
11 x 11 (G 56) 4,3" x 4,3"



TEMPO PATTERN SAND
11 x 11 (G 56) 4,3" x 4,3"

TEMPO PATTERN SAND PERMITE
MÚLTIPLES POSIBILIDADES
COMPOSITIVAS

TEMPO PATTERN SAND OFFERS
INFINITE COMPOSITIVE
POSSIBILITIES

PACKING DECOR

FORMATO	PULGADAS	PZ/CAJA	M ²	CAJA/PLT	PESO/CAJA	PESO/PLT
11 x 11	4,3" x 4,3"	40	0,5	144	10,15	1491

TEMPO

EVOLUTION
EXTRUDED PORCELAIN TILE

RESISTE LA FLEXIÓN	RESISTE EL DESGASTE	RESISTE EL RAYADO	ANTIDESLIZANTE	MANCHAS	ABSORCIÓN	DILATACIÓN
32 N/m ²	PEI (II - V)	MOHS-7	Class I - R9	Class S - Class A	<0,3%	5,7" 10" / °C

PAV. DE INTERIOR INDOOR FLOOR TILE	REVESTIMIENTO WALL TILE	SUPERFICIE BRILLO SURFACE BRIGHTNESS	SIN MANTENIMIENTO NO MAINTENANCE	RES. A ÁCIDOS Y BASES RES. TO ACIDS AND BASES	RES. A LA HELADA FROST PROOF	DESTONIFICADO ARMONIOSO CONTROLLED DESTONIFICATION



DECORACIÓN · DECORATION

La serie TEMPO combina con las bases de la serie TEMPO pág. 156-157
TEMPO combines with TEMPO collection, pág. 156-157

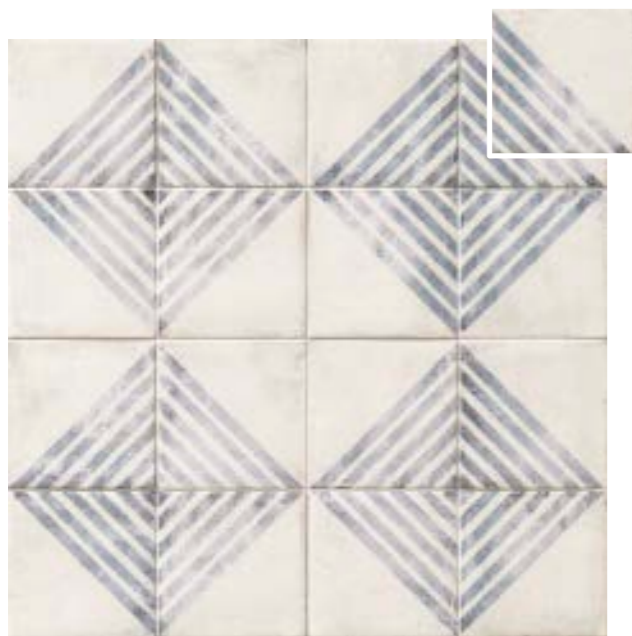

TEMPO ROADS ATLANTIC
22,5 x 22,5 (G 57) 8,8" x 8,8" m



TEMPO TANGRAM ATLANTIC
22,5 x 22,5 (G 57) 8,8" x 8,8" m



TEMPO PATTERN CAVIAR
22,5 x 22,5 (G 57) 8,8" x 8,8" m



TEMPO ROADS CAVIAR
22,5 x 22,5 (G 57) 8,8" x 8,8" m

TEMPO ROADS CAVIAR PERMITE
MÚLTIPLES POSIBILIDADES
COMPOSITIVAS
TEMPO ROADS CAVIAR OFFERS
INFINITE COMPOSITIVE
POSSIBILITIES



PACKING DECOR

FORMATO	PULGADAS	PZ/CAJA	M ²	CAJA/PLT	PESO/CAJA	PESO/PLT
22,5 x 22,5	8,8" x 8,8"	20	1,01	72	20,7	1,505

CONCRET



FORMATOS:
 9 x 36 - 3,5" x 14"
 HEXAGONO 22,5 x 26 - 9" x 10"
 CHEVRON 11 x 26 - 4" x 10"

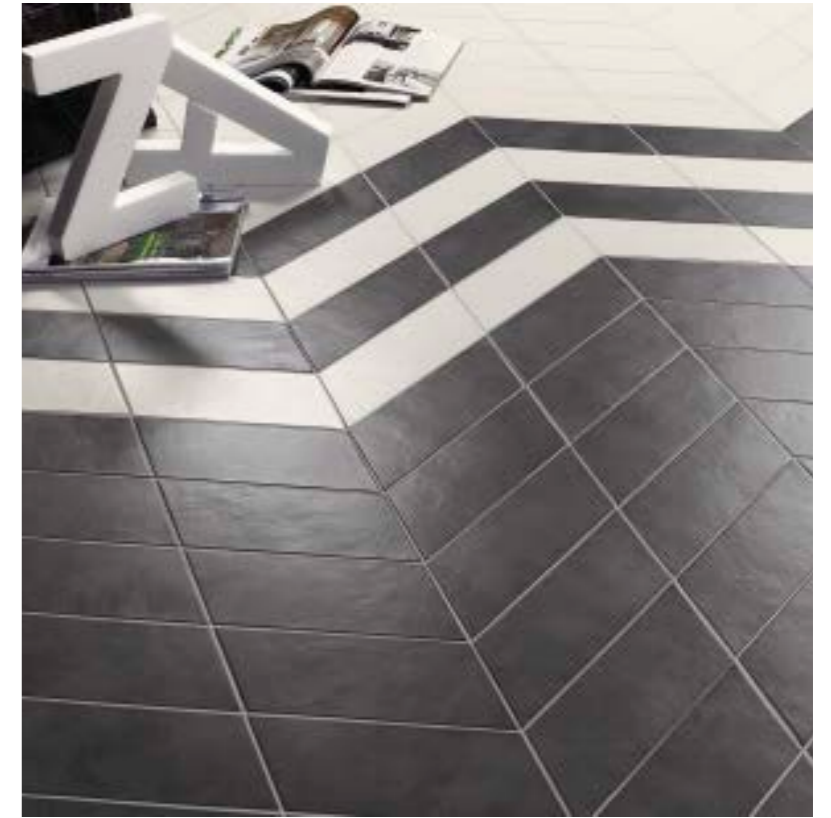

COLORES · COLOURS

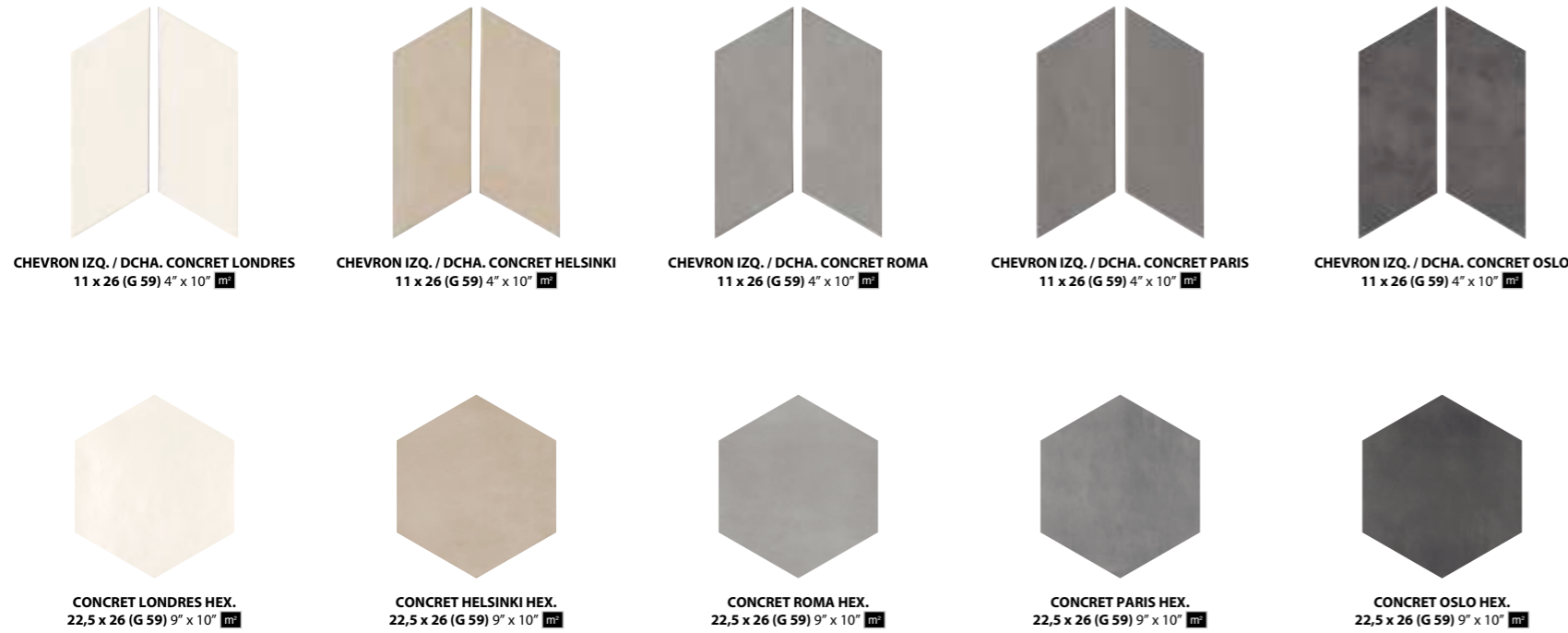

PACKING BASES

FORMATO	PULGADAS	PZ/CAJA	M ²	CAJA/PLT	PESO/CAJA	PESO/PLT
HEX. 22,5 x 26	9" x 10"	15	0,66	96	15,21	1474
CHEVRON 11 x 26	4" x 10"	18	0,514	96	11,6	1130
9 x 36	3,5" x 14"	30	1	72	21,1	1533

PACKING PIEZAS ESPECIALES

FORMATO	PULGADAS	PZ/CAJA	ML	CAJA/PLT	PESO/CAJA	PESO/PLT
DEMI BULLNOSE 1,5 x 30	0,6" x 11,8"	50	15	120	2,2	276

COLORES · COLOURS

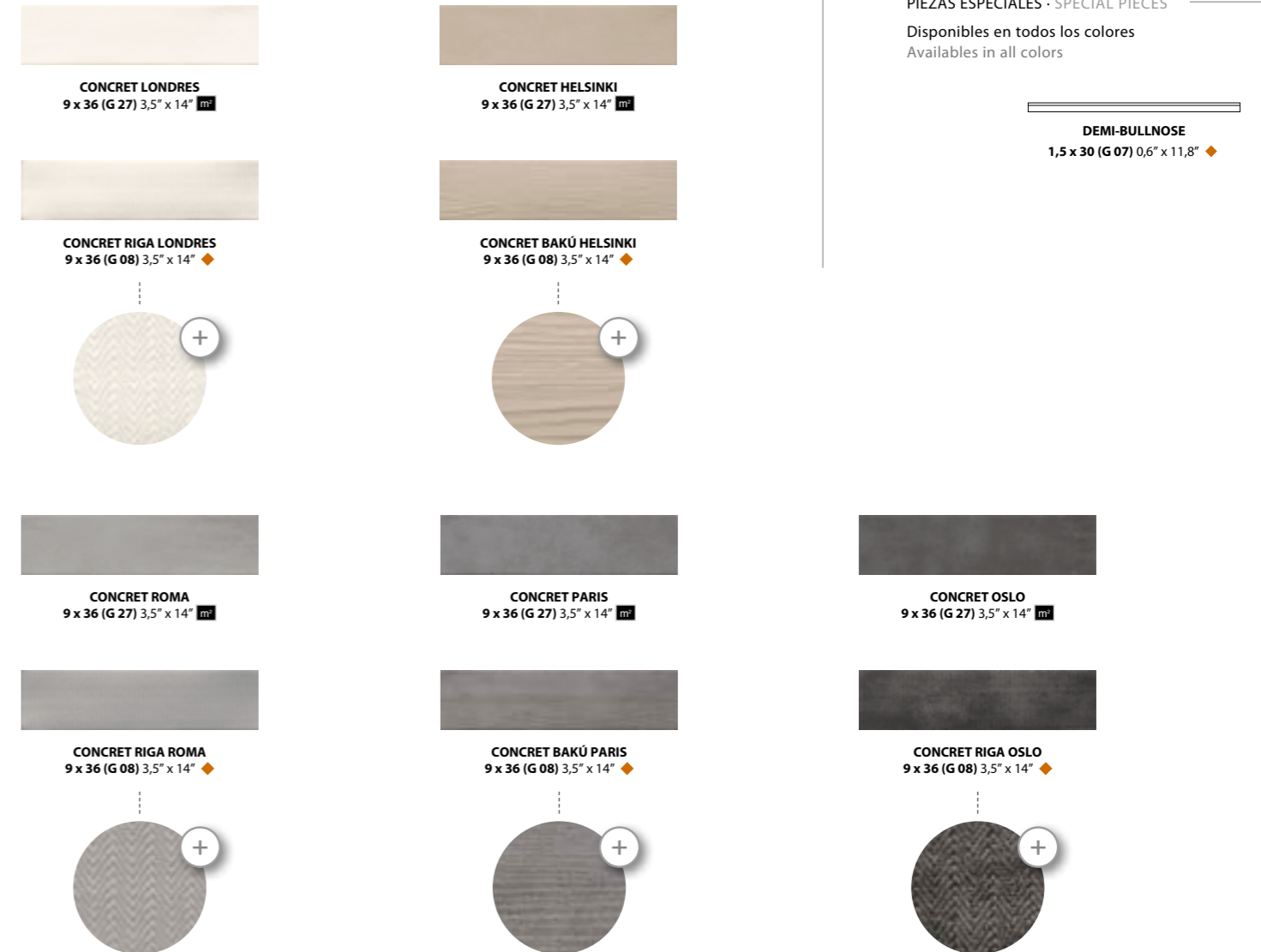

MARE NOSTRUM

Comfort floor
EVOLUTION
EXTRUDED PORCELAIN TILE

RESISTE LA FLEXIÓN
32 N/mm2

RESISTE EL DESGASTE
PEI (I-V)

RESISTE EL RAYADO
MOHS - 4

ANTIDESLIZANTE
Class I

MANCHAS
Class 5 - Class A

ABSORCIÓN
0,2%

DILATACIÓN
5,7* 10⁻⁴ / °C

FORMATOS
7 x 45 - 3" x 17,7"
18 x 18 - 7" x 7"
36 x 36 - 14" x 14"
HEXAGONO 18 x 20,5 - 7" x 8"
PROVENZAL 26,5 x 20,5 - 10,3" x 8"

PE GRES EXTRUSIONADO PORCELÁNICO
PORCELAIN EXTRUDED TILE

SUPERFICIE BRILLO
SURFACE BRIGTNES

PAV. DE INTERIOR
INDOOR FLOOR TILE

REVESTIMIENTO
WALL TILE

SIN MANTENIMIENTO
NO MAINTENANCE

RES. A ÁCIDOS Y BASES
RES. TO ACIDS AND BASES

RES. A LA HELADA
FROST PROOF



COLORES · COLOURS



MARE NOSTRUM HEX. IBIZA
18 x 20,5 (G 39) 7" x 8"

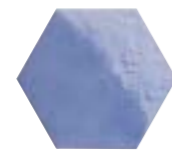

MARE NOSTRUM HEX. NÁPOLES
18 x 20,5 (G 39) 7" x 8"

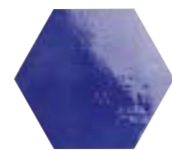

MARE NOSTRUM HEX. MESSINA
18 x 20,5 (G 39) 7" x 8"

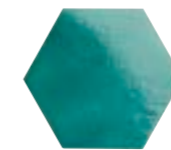

MARE NOSTRUM HEX. GÉNOVA
18 x 20,5 (G 39) 7" x 8"

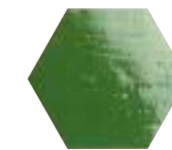

MARE NOSTRUM HEX. MÓNACO
18 x 20,5 (G 39) 7" x 8"

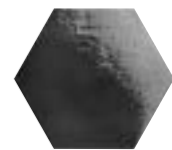

MARE NOSTRUM HEX. NIZA
18 x 20,5 (G 39) 7" x 8"



MARE NOSTRUM IBIZA
7 x 45 (G 27) 3" x 17,7"



MARE NOSTRUM NÁPOLES
7 x 45 (G 27) 3" x 17,7"



MARE NOSTRUM MESSINA
7 x 45 (G 27) 3" x 17,7"



MARE NOSTRUM GÉNOVA
7 x 45 (G 27) 3" x 17,7"



MARE NOSTRUM MÓNACO
7 x 45 (G 27) 3" x 17,7"



MARE NOSTRUM NIZA
7 x 45 (G 27) 3" x 17,7"

PACKING BASES

FORMATO	PULGADAS	PZ/CAJA	M²	CAJA/PLT	PESO/CAJA	PESO/PLT
7 x 45	3" x 17,7"	32	1	60	21,4	1.300
HEX. 18 x 20,5	7" x 8"	36	1	48	21	1.024

MARE NOSTRUM

Comfort floor
EVOLUTION
EXTRUDED PORCELAIN TILE

RESISTE LA FLEXIÓN
32 N/mn2

RESISTE EL DESGASTE
PEI (I-V)

RESISTE EL RAYADO
MOHS - 4

ANTIDESLIZANTE
Class I

MANCHAS
Class 5 - Class A

ABSORCIÓN
0,2%

DILATACIÓN
5,7* 10⁻⁴ / °C

FORMATOS
7 x 45 - 3" x 17,7"
18 x 18 - 7" x 7"
36 x 36 - 14" x 14"
HEXAGONO 18 x 20,5 - 7" x 8"
PROVENZAL 26,5 x 20,5 - 10,3" x 8"

GRES EXTRUSIONADO PORCELÁNICO
PORCELAIN EXTRUDED TILE

SUPERFICIE BRILLO
SURFACE BRIGTNES

PAV. DE INTERIOR
INDOOR FLOOR TILE

REVESTIMIENTO
WALL TILE

SIN MANTENIMIENTO
NO MAINTENANCE

RES. A ÁCIDOS Y BASES
RES. TO ACIDS AND BASES

RES. A LA HELADA
FROST PROOF



PROVENZAL · PROVENZAL



PROVENZAL IBIZA
26,5 x 20,5 (G 55) 10,3" x 8" m



PROVENZAL MESSINA
26,5 x 20,5 (G 55) 10,3" x 8" m



PROVENZAL GENOVA
26,5 x 20,5 (G 55) 10,3" x 8" m



PROVENZAL NIZA
26,5 x 20,5 (G 55) 10,3" x 8" m

COLORES · COLOURS



MARE NOSTRUM IBIZA
18 x 18 (G 57) 7" x 7" m



MARE NOSTRUM ATENAS
18 x 18 (G 57) 7" x 7" m



MARE NOSTRUM BARCELONA
18 x 18 (G 57) 7" x 7" m



MARE NOSTRUM NIZA
18 x 18 (G 57) 7" x 7" m



MARE NOSTRUM NÁPOLES
18 x 18 (G 57) 7" x 7" m



MARE NOSTRUM MESSINA
18 x 18 (G 57) 7" x 7" m



MARE NOSTRUM GÉNOVA
18 x 18 (G 57) 7" x 7" m



MARE NOSTRUM MÓNACO
18 x 18 (G 57) 7" x 7" m



MARE NOSTRUM IBIZA
36 x 36 (G 57) 14" x 14" m



MARE NOSTRUM ATENAS
36 x 36 (G 57) 14" x 14" m



MARE NOSTRUM BARCELONA
36 x 36 (G 57) 14" x 14" m



MARE NOSTRUM NIZA
36 x 36 (G 57) 14" x 14" m



MARE NOSTRUM NÁPOLES
36 x 36 (G 57) 14" x 14" m



MARE NOSTRUM MESSINA
36 x 36 (G 57) 14" x 14" m



MARE NOSTRUM GÉNOVA
36 x 36 (G 57) 14" x 14" m



MARE NOSTRUM MÓNACO
36 x 36 (G 57) 14" x 14" m

PACKING BASES

FORMATO	PULGADAS	PZ/CAJA	M²	CAJA/PLT	PESO/CAJA	PESO/PLT
18 x 18	7" x 7"	30	0,97	72	21,4	1.555
36 x 36	14" x 14"	8	1	48	22,04	1.072
PROVENZAL 26,5 x 20,5	10,3" x 8"	18	0,98	42	19,6	836

PACKING PIEZAS ESPECIALES

FORMATO	PULGADAS	PZ/CAJA	ML	CAJA/PLT	PESO/CAJA	PESO/PLT
DEMI BULLNOSE 1,5 x 30	0,6" x 11,8"	50	15	120	2,2	276
ZÓCALO 9 x 36	3,5" x 14"	56	10,8	48	22,5	1.275

PIEZAS ESPECIALES · SPECIAL PIECES

COLORES

IBIZA

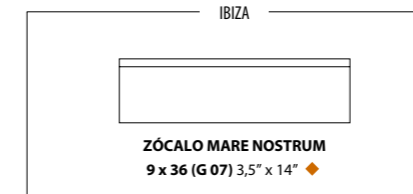

DISPONIBLE EN TODOS LOS COLORES
AVAILABLE IN ALL COLOURS

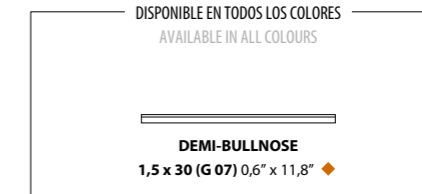

-  REVESTIMIENTO WALL TILE
-  SUPERFICIE SATINADO GLOSSY SURFACE
-  SIN MANTENIMIENTO NO MAINTENANCE
-  RESISTENTE AL DESGASTE WEAR RESISTANCE
-  RESIST. A LA HELADA FROST PROOF
-  DESTONIFICADO ARMONIOSO CONTROLLED DESTONIFICATION

FORMATOS
25 x 50 - 10" x 20"
5 x 25 - 2" x 10"
21 x 36 - 8" x 14"



TIRA ENMALLADO TRABADA MATSTONE



TIRA ENM. TRABADA MATSTONE MILK
25 x 50 (G 17) 10" x 20"

Compuesta por: TIRA A-10 / B-10 / C-8 / D-10 / E-8



TIRA ENM. TRABADA MATSTONE BEIGE
25 x 50 (G 17) 10" x 20"

Compuesta por: TIRA A-10 / B-10 / C-8 / D-10 / E-8



TIRA ENM. TRABADA MATSTONE ASH
25 x 50 (G 17) 10" x 20"

Compuesta por: TIRA A-10 / B-10 / C-8 / D-10 / E-8



TIRA ENM. TRABADA MATSTONE VALGE
25 x 50 (G 17) 10" x 20"



TIRA ENM. TRABADA MATSTONE KULD
25 x 50 (G 17) 10" x 20"



TIRA ENM. TRABADA MATSTONE VASK
25 x 50 (G 17) 10" x 20"



TIRA ENM. TRABADA MATSTONE MUST
25 x 50 (G 17) 10" x 20"

TIRA ENMALLADO MATSTONE

También disponible en MILK, BEIGE y ASH
Available in MILK, BEIGE y Rope ASH



TIRA ENM. MATSTONE VALGE
25 x 50 (G 17) 10" x 20"

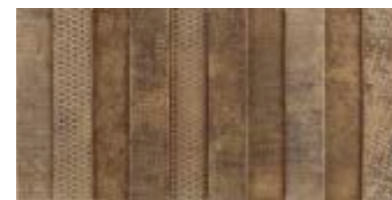

TIRA ENM. MATSTONE KULD
25 x 50 (G 17) 10" x 20"

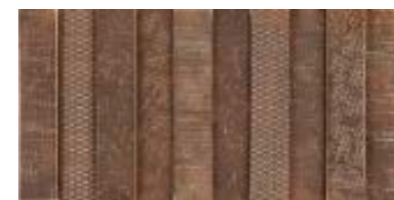

TIRA ENM. MATSTONE VASK
25 x 50 (G 17) 10" x 20"

(Compuesta por: TIRA A-10 / B-10 / C-8 / D-10 / E-8)
(Composed by: TIRA A-10 / B-10 / C-8 / D-10 / E-8)

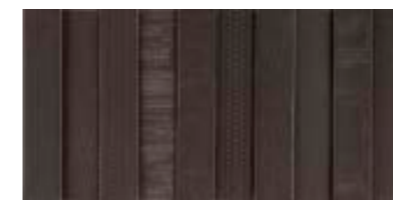

TIRA ENM. MATSTONE MUST
25 x 50 (G 17) 10" x 20"

TIRA MATSTONE

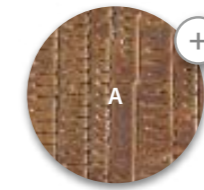

TIRA MATSTONE
5 x 25 (G 03) 2" x 10"

A-8
VALGE
KULD
VASK
MUST

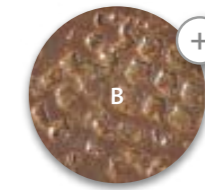

TIRA MATSTONE
5 x 25 (G 03) 2" x 10"

B-8
VALGE
KULD
VASK
MUST



TIRA MATSTONE
5 x 25 (G 03) 2" x 10"

C-8
VALGE
KULD
VASK
MUST
MILK
BEIGE
ASH

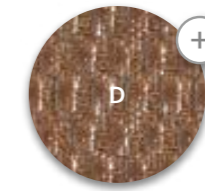

TIRA MATSTONE
5 x 25 (G 03) 2" x 10"

D-8
VALGE
KULD
VASK
MUST



TIRA MATSTONE
5 x 25 (G 03) 2" x 10"

E-8
VALGE
KULD
VASK
MUST
MILK
BEIGE
ASH

2 ESPESORES · 2 THICKNESS

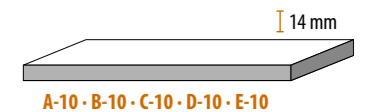
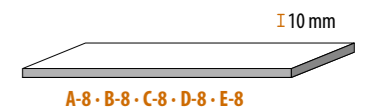

PACKING BASES

FORMATO	PULGADAS	PZ/CAJA	M ²	CAJA/PLT	PESO/CAJA	PESO/PLT
25 x 50 LINEAL	10" x 20"	4	0,5	60	12,5	770
25 x 50 TRABADA	10" x 20"	4	0,5	40	12,5	520

PACKING BASES

FORMATO	PULGADAS	PZ/CAJA	M ²	CAJA/PLT	PESO/CAJA	PESO/PLT
5 x 25/8	2" x 10"	18	0,23	196	4,38	873
5 x 25/10	2" x 10"	14	0,18	196	5,56	1.104

MATSTONE

PAVIMENTO

EVOLUTION
EXTRUDED PORCELAIN TILE
Comfort floor
INTERIOR CLASE I
UNE. 41901:2017 EX

PAVIMENTO DE EXTERIOR
OUTDOOR FLOOR TILE
PAVIMENTO DE INTERIOR
INDOOR FLOOR TILE
SUPERFICIE SATINADO
GLOSSY SURFACE

RESISTENTE AL DESGASTE
WEAR RESISTANCE
RESIST. A LA HELADA
FROST PROOF
DESTONIFICADO ARMONIOSO
CONTROLLED DESTONIFICATION

FORMATOS
25 x 50 - 10" x 20"
21 x 36 - 8" x 14"



ENMALLADO MATSTONE



ESPIGA MATSTONE VALGE
21 x 36 (G 30) 8" x 14" ◆



ESPIGA MATSTONE KULD
21 x 36 (G 30) 8" x 14" ◆



ESPIGA MATSTONE VASK
21 x 36 (G 30) 8" x 14" ◆



ESPIGA MATSTONE MUST
21 x 36 (G 30) 8" x 14" ◆

También disponible en MILK, BEIGE y ASH
(Compuesta por: TIRA A-10 / B-10 / D-10)
Availables in MILK, BEIGE y Rope ASH
(Composed by: TIRA A-10 / B-10 / D-10)

ESPIGA MATSTONE



MATSTONE VALGE
25 x 50 (G 17) 10" x 20" ◆



MATSTONE KULD
25 x 50 (G 17) 10" x 20" ◆

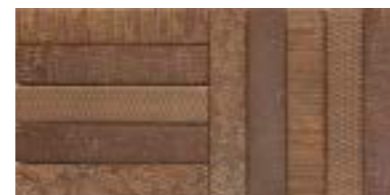

MATSTONE VASK
25 x 50 (G 17) 10" x 20" ◆



MATSTONE MUST
25 x 50 (G 17) 10" x 20" ◆

También disponible en MILK, BEIGE y ASH
(Compuesta por: TIRA A-10 / B-10 / D-10)
Availables in MILK, BEIGE y Rope ASH
(Composed by: TIRA A-10 / B-10 / D-10)

PACKING BASES

FORMATO	PULGADAS	PZ/CAJA	M ²	CAJA/PLT	PESO/CAJA	PESO/PLT
PAV. 25 x 50	10" x 20"	5	0,625	60	12	740
PAV. 21 x 36	8" x 14"	5	0,38	60	9,1	560

FIGURES

Comfort floor
EVOLUTION
EXTRUDED PORCELAIN TILE

PAV. DE INTERIOR
INDOOR FLOOR TILE

REVESTIMIENTO
WALL TILE

SIN MANTENIMIENTO
NO MAINTENANCE

SUPERFICIE SATINADO
GLOSSY SURFACE

SUPERFICIE BRILLO
SURFACE BRIGTNES

FORMATOS:

15,9 x 18 - 6,3" x 7"
15,5 x 15,5 - 6" x 6"
5 x 25 - 2" x 10"

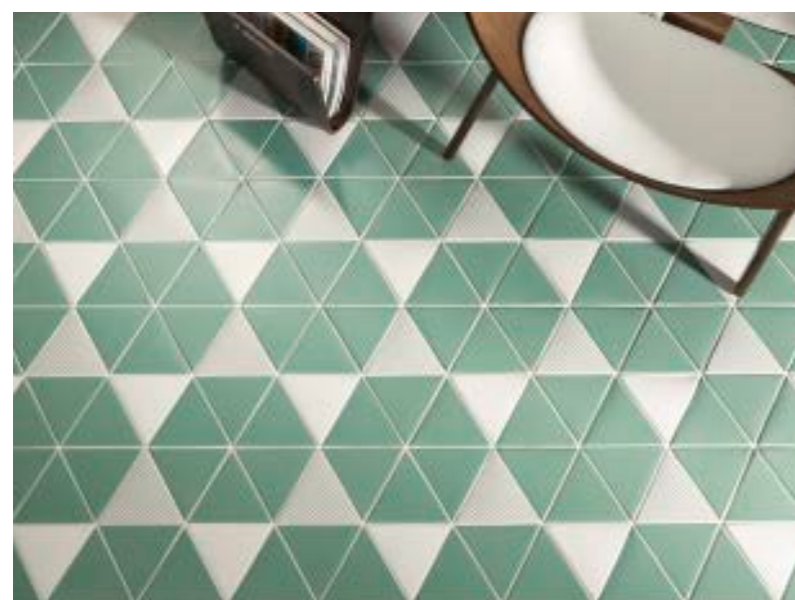

ANGULOS REDONDEADOS · ROUNDED EDGES



FIGURES TRIANGLE BLANC
15,9 x 18 (G 42) 6,3" x 7" m²



FIGURES TRIANGLE ARC
15,9 x 18 (G 42) 6,3" x 7" m²



FIGURES TRIANGLE ESTEL
15,9 x 18 (G 42) 6,3" x 7" m²



FIGURES TRIANGLE BRONZE
15,9 x 18 (G 54) 6,3" x 7" m²



FIGURES TRIANGLE ORO
15,9 x 18 (G 54) 6,3" x 7" m²



FIGURES TRIANGLE PLATA
15,9 x 18 (G 54) 6,3" x 7" m²



FIGURES TRIANGLE ROSAT
15,9 x 18 (G 64) 6,3" x 7" m²



FIGURES TRIANGLE CARMIN
15,9 x 18 (G 64) 6,3" x 7" m²



FIGURES TRIANGLE POMME
15,9 x 18 (G 64) 6,3" x 7" m²



FIGURES TRIANGLE VERT
15,9 x 18 (G 64) 6,3" x 7" m²



FIGURES TRIANGLE BLEU
15,9 x 18 (G 64) 6,3" x 7" m²

DETALLE DETAIL



ANGULOS REDONDEADOS
ROUNDED EDGES

ANGULOS RECTOS · STRAIGHT EDGES



FIGURES TRIANGLE NATURAL
15,9 x 18 (G 42) 6,3" x 7" m²



FIGURES TRIANGLE DOBLE
15,9 x 18 (G 42) 6,3" x 7" m²



FIGURES RECTANGLE NATURAL
5 x 25 (G 60) 2" x 10" m²



FIGURES QUADRAT NATURAL
15,5 x 15,5 (G 60) 6" x 6" m²



FIGURES QUADRAT DOBLE
15,5 x 15,5 (G 60) 6" x 6" m²



FIGURES QUADRAT ORO
15,5 x 15,5 (G 46) 6" x 6" m²



FIGURES QUADRAT BRONZE
15,5 x 15,5 (G 46) 6" x 6" m²

DETALLE DETAIL



ANGULOS RECTOS
STRAIGHT EDGES

DETALLE DETAIL



ANGULOS RECTOS
STRAIGHT EDGES

PACKING BASES

FORMATO	PULGADAS	PZ/CAJA	M²	CAJA/PLT	PESO/CAJA	PESO/PLT
15,9 x 18	6,3" x 7"	34	0,485	108	9,76	1070

PACKING BASES

FORMATO	PULGADAS	PZ/CAJA	M²	CAJA/PLT	PESO/CAJA	PESO/PLT
15,9 x 18	6,3" x 7"	34	0,485	108	9,76	1070
DOBLE 15,9 x 18	6,3" x 7"	34	0,485	108	9,76	1070
15,5 x 15,5	6" x 6"	28	0,67	80	13,48	1094
DOBLE 15,5 x 15,5	6" x 6"	28	0,67	80	13,48	1094
5 x 25	2" x 10"	48	0,60	78	12,48	989

SQUAMA

EVOLUTION
EXTRUDED PORCELAIN TILE
Pasta Blanca

- REVESTIMIENTO WALL TILE
- SUPERFICIE BRILLO SURFACE BRIGHTNESS
- SIN MANTENIMIENTO NO MAINTENANCE

FORMATOS:
ESCAMA 12,7 x 6,2 - 5" x 2,5"



EVOLUTION
EXTRUDED PORCELAIN TILE



SQUAMA PORC. LUZ
12,7 x 6,2 (G 51) 5" x 2,5" m²



SQUAMA PORC. IRON
12,7 x 6,2 (G 51) 5" x 2,5" m²



SQUAMA PORC. CLOUD
12,7 x 6,2 (G 51) 5" x 2,5" m²



SQUAMA PORC. OCEAN
12,7 x 6,2 (G 51) 5" x 2,5" m²

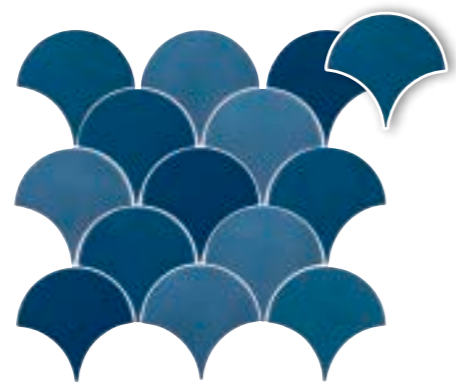

SQUAMA PORC. INDIGO
12,7 x 6,2 (G 51) 5" x 2,5" m²

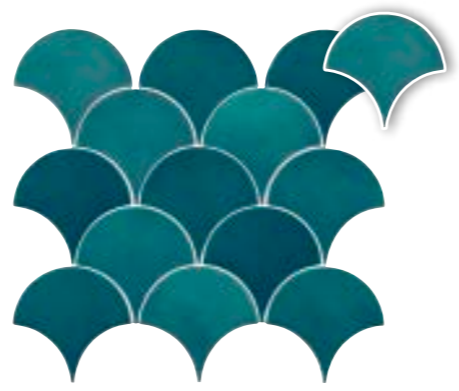

SQUAMA PORC. EMERALD
12,7 x 6,2 (G 51) 5" x 2,5" m²



SQUAMA RICE
12,7 x 6,2 (G 63) 5" x 2,5" m²



SQUAMA MIST
12,7 x 6,2 (G 63) 5" x 2,5" m²



SQUAMA MAYA
12,7 x 6,2 (G 63) 5" x 2,5" m²

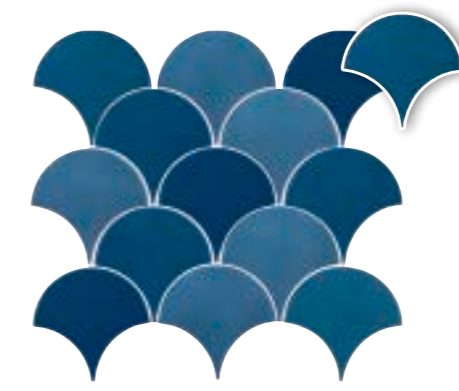

SQUAMA TURCHESE
12,7 x 6,2 (G 63) 5" x 2,5" m²

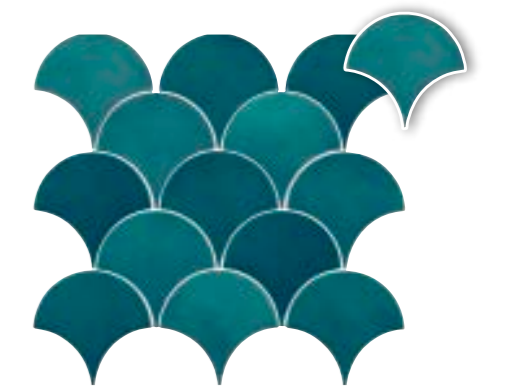

SQUAMA OLIVE
12,7 x 6,2 (G 63) 5" x 2,5" m²

Pasta Blanca

PIEZAS ESPECIALES · SPECIAL PIECES

PIEZAS ESPECIALES · SPECIAL PIECES

Disponibles en todos los colores
Availables in all colors



BOX SQUAMA PORC. LUZ
12,7 x 6,2 (G 17) 5" x 2,5" ◆



BOX SQUAMA PORC. OCEAN
12,7 x 6,2 (G 17) 5" x 2,5" ◆



BOX SQUAMA PORC. EMERALD
12,7 x 6,2 (G 17) 5" x 2,5" ◆

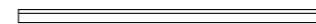

DEMI-BULLNOSE
1,5 x 30 (G 07) 0,6" x 11,8" ◆

PACKING BASES PORCELÁNICO

FORMATO	PULGADAS	PZ/CAJA	M²	CAJA/PLT	PESO/CAJA	PESO/PLT
ESCAMA 12,7 x 6,2	5" x 2,5"	45	0,35	78	8,7	689

PACKING BASES PASTA BLANCA

FORMATO	PULGADAS	PZ/CAJA	M²	CAJA/PLT	PESO/CAJA	PESO/PLT
ESCAMA 12,7 x 6,2	5" x 2,5"	48	0,377	78	6,65	532

PACKING PIEZAS ESPECIALES

FORMATO	PULGADAS	PZ/CAJA	ML	CAJA/PLT	PESO/CAJA	PESO/PLT
DEMI BULLNOSE 1,5 x 30	0,6" x 11,8"	50	15	120	2,2	276
BOX SQUAMA PORC. 12,7 x 6,2	5" x 2,5"	8	1,02	78	2,60	218

CAPRICE

EVOLUTION
EXTRUDED PORCELAIN TILE

 VOLUMEN
VOLUME
 SUPERFICIE SATINADO
GLOSSY SURFACE

FORMATOS:
ENM. HEX. 45,5 x 20 - 17,7" x 8"
HEX. 13 x 11,4 - 5" x 4"
ESCAMA 12,7 x 6,2 - 5" x 2,5"



CON RELIEVE - EMBOSSED



CENTRO HEXÁGONO CAPRICE BIANCO
45,5 x 20 (G 31) 17,7" x 8" 



CENTRO HEXÁGONO CAPRICE NOTTE
45,5 x 20 (G 31) 17,7" x 8" 

SIN RELIEVE - SMOOTH



CAPRICE HEX. ENM. BIANCO SMOOTH
45,5 x 20 (G 31) 17,7" x 8" 

Varios DISEÑOS
Se suministran mezclados
Several DESIGNS
Supplied mixed



CAPRICE BIANCO SMOOTH
13 x 11,4 (G 50) 5" x 4" 



CAPRICE HEX. ENM. NOTTE SMOOTH
45,5 x 20 (G 31) 17,7" x 8" 

Varios DISEÑOS
Se suministran mezclados
Several DESIGNS
Supplied mixed



CAPRICE NOTTE SMOOTH
13 x 11,4 (G 50) 5" x 4" 

ESCAMA - SCALE



3 DISEÑOS DIFERENTES - Se suministran mezclados
3 DIFFERENTS DESIGNS - Supplied mixed



PACKING BASES

FORMATO	PULGADAS	PZ/CAJA	M²	CAJA/PLT	PESO/CAJA	PESO/PLT
HEX. 13 x 11,4	5" x 4"	36	0,4	98	9,14	909
HEX. 13 x 11,4 GRUESO	5" x 4"	26	0,29	98	9,2	916
ENM. HEX. 45,5 x 20	17,5" x 8"	5	0,455	112	10,1	1.145
ESCAMA 12,7 x 6,2	5" x 2,5"	51	0,401	78	10	780

CAPRICE

EVOLUTION
EXTRUDED PORCELAIN TILE

 **VOLUMEN**
VOLUME

 **SUPERFICIE SATINADO**
GLOSSY SURFACE

FORMATOS:

OCTG. 7 17 x 17 - 6,6" x 6,6"
TACO 7 x 7 - 2,7" x 2,7"
OCTG. 5 12,2 x 12,2 - 4,8" x 4,8"
TACO 5 x 5 - 2" x 2"
OCTG. 4 16,7 x 16,7 - 6,5" x 6,5"
TACO 4,8 x 4,8 - 2" x 2"



BASE - BASE

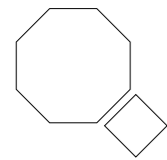

OCTG. 7 17 x 17 (G 06) 6,6" x 6,6" ♦
TACO 7 x 7 (G 01) 2,7" x 2,7" ♦

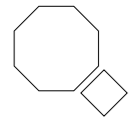

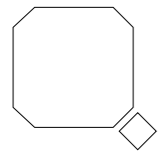

OCTG. 5 12,2 x 12,2 (G 03) 4,8" x 4,8" ♦
TACO 5 x 5 (G 01) 2" x 2" ♦



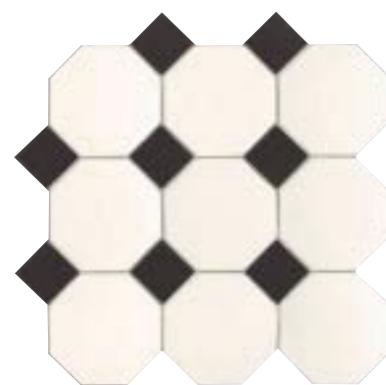

OCTG. 4 16,7 x 16,7 (G 06) 6,5" x 6,5" ♦
TACO 4,8 x 4,8 (G 01) 2" x 2" ♦

ENMALLADOS - ON A MESH





ENMALLADO OCTG. BIANCO -7 (17x17)
35 x 35 (G 50) 13,7" x 13,7"  



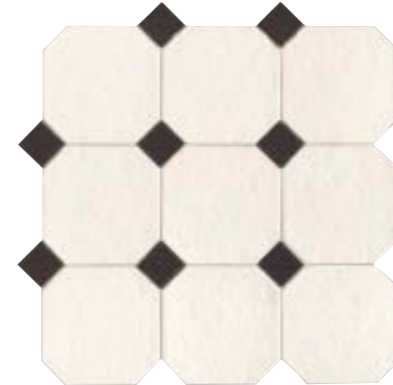

ENMALLADO OCTG. BIANCO -5 (12,2x12,2)
37 x 37 (G 52) 14,5" x 14,5"  



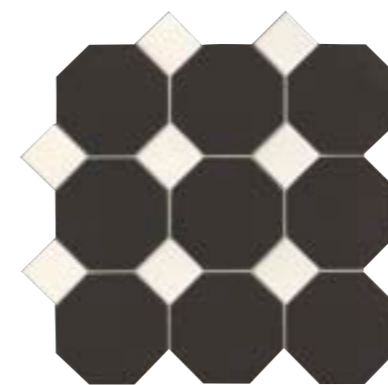

ENMALLADO OCTG. BIANCO -4 (16,7x16,7)
34 x 34 (G 51) 13,3" x 13,3"  



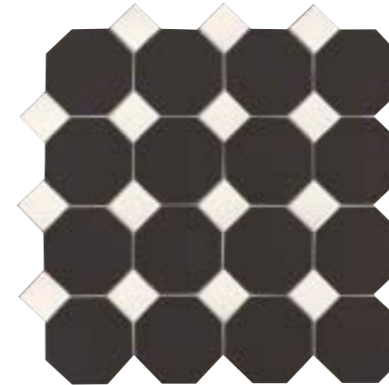

ENMALLADO OCTG. NOTTE -7 (17x17)
35 x 35 (G 50) 13,7" x 13,7"  

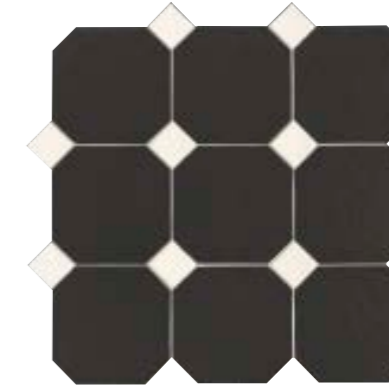

ENMALLADO OCTG. NOTTE -5 (12,2x12,2)
37 x 37 (G 52) 14,5" x 14,5"  



ENMALLADO OCTG. NOTTE -4 (16,7x16,7)
34 x 34 (G 51) 13,3" x 13,3"  

PACKING BASES

FORMATO	PULGADAS	PZ/CAJA	M ²	CAJA/PLT	PESO/CAJA	PESO/PLT
17 x 17	6,6" x 6,6"	31	0,74	72	17,15	1.250
12,2 x 12,2	4,8" x 4,8"	42	0,525	60	12,90	790
16,7 x 16,7	6,5" x 6,5"	31	0,727	72	16,90	1.235
ENM. OCT. 7 35 x 35	13,7" x 13,7"	7	0,86	56	15,35	878
ENM. OCT. 5 37 x 37	14,5" x 14,5"	7	0,96	56	21,7	1.235
ENM. IRREG. 34 x 34	13,3" x 13,3"	7	0,81	56	16,05	913

PACKING PIEZAS ESPECIALES

FORMATO	PULGADAS	PZ/CAJA	ML	CAJA/PLT	PESO/CAJA
TACO 7 x 7	2,7" x 2,7"	58	4,06	60	2,38
TACO 5 x 5	2" x 2"	90	4,5	60	2,10
TACO 4,8 x 4,8	2" x 2"	90	4,32	60	1,85

COMPOSICIÓN POR M ² :						
Caprice Octg. -7	17 x 17	35 Pz.	+	Taco Caprice	7 x 7	35 Pz.
Caprice Octg. -5	12,2 x 12,2	68 Pz.	+	Taco Caprice	5 x 5	68 Pz.
Caprice Octg. -4	16,7 x 16,7	36 Pz.	+	Taco Caprice	4,8 x 4,8	36 Pz.

NEW PANAL

Comfort floor
EVOLUTION
EXTRUDED PORCELAIN TILE

PAV. DE INTERIOR
INDOOR FLOOR TILE

REVESTIMIENTO
WALL TILE

SIN MANTENIMIENTO
NO MAINTENANCE

RESISTENCIA AL RAYADO
SCRATCH RESISTANCE

RESIST. A LA HELADA
FROST PROOF

RESISTENTE AL DESGASTE
WEAR RESISTANCE

FORMATOS:

CHEVRON IZQ./DCHA. 17,2 x 7,3 · 7" x 3"
ROMBO 15 x 8,5 · 6" x 3,3"
HEX. 15 x 17 · 6" x 7"
HEX. 6,5 x 7,5 · 2,5" x 3"
HEX. 6,5 x 22,5 · 2,5" x 8,8"
ENM. HEX. 38 x 39,5 · 15" x 15,5"



HEXÁGONO (14) · HEXAGON (14)

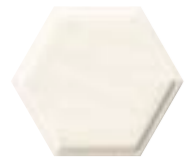

HEX. (14) NEW PANAL FARINA
15 x 17 (G 64) 6" x 7" m²



HEX. (14) NEW PANAL BEIGE
15 x 17 (G 64) 6" x 7" m²



HEX. (14) NEW PANAL ASH
15 x 17 (G 64) 6" x 7" m²



DETALLE
DETAIL
HEX. (14)
15 x 17 · 6" x 7"

CHEVRON (14) · CHEVRON (14)



CHEVRON IZQ. / DCHA. (14)
NEW PANAL FARINA
17,2 x 7,3 (G 64) 7" x 3" m²



CHEVRON IZQ. / DCHA. (14)
NEW PANAL FARINA DECOR
17,2 x 7,3 (G 64) 7" x 3" m²



CHEVRON IZQ. / DCHA. (14)
NEW PANAL BEIGE
17,2 x 7,3 (G 64) 7" x 3" m²



CHEVRON IZQ. / DCHA. (14)
NEW PANAL ASH
17,2 x 7,3 (G 64) 7" x 3" m²



DETALLE
DETAIL
CHEVRON (14)
IZQ./DCHA.
17,2 x 7,3 · 7" x 3"

HEXÁGONO (10) · HEXAGON (10)

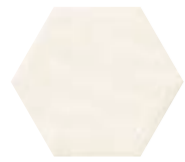

HEX. (10) NEW PANAL FARINA
15 x 17 (G 63) 6" x 7" m²
6,5 x 7,5 (G 61) 2,5" x 3" m²
6,5 x 22,5 (G 61) 2,5" x 8,8" m²
ENM. 38 x 39,5 (G 36) 15" x 15,5" m²



HEX. (10) NEW PANAL CREAM
15 x 17 (G 63) 6" x 7" m²

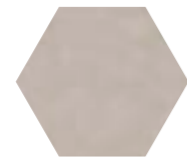

HEX. (10) NEW PANAL STORM
15 x 17 (G 63) 6" x 7" m²

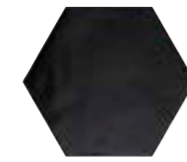

HEX. (10) NEW PANAL CARBO
15 x 17 (G 63) 6" x 7" m²



DETALLE
DETAIL
HEX. (10)
15 x 17 · 6" x 7"

CHEVRON (10) · CHEVRON (10)



CHEVRON IZQ. / DCHA. (10)
NEW PANAL FARINA
17,2 x 7,3 (G 63) 7" x 3" m²



CHEVRON IZQ. / DCHA. (10)
NEW PANAL CREAM
17,2 x 7,3 (G 63) 7" x 3" m²



CHEVRON IZQ. / DCHA. (10)
NEW PANAL STORM
17,2 x 7,3 (G 63) 7" x 3" m²



CHEVRON IZQ. / DCHA. (10)
NEW PANAL CARBO
17,2 x 7,3 (G 63) 7" x 3" m²



DETALLE
DETAIL
CHEVRON (10)
IZQ./DCHA.
17,2 x 7,3 · 7" x 3"

PACKING BASES

FORMATO	PULGADAS	PZ/CAJA	M²	CAJA/PLT	PESO/CAJA	PESO/PLT
HEX. 15 x 17 (10)	6" x 7"	26	0,5	80	12,45	1.010
HEX. 15 x 17 (14)	6" x 7"	19	0,37	80	10,57	861
HEX. 6,5 x 7,5	2,5" x 3"	104	0,5	80	12,06	979
HEX. 6,5 x 22,5	2,5" x 8,8"	40	0,585	80	13,7	1110
ENMALLADO HEX. 38 x 39,5	15" x 15,5"	7	1,14	56	25	1.419

PACKING BASES

FORMATO	PULGADAS	PZ/CAJA	M²	CAJA/PLT	PESO/CAJA	PESO/PLT
CHEVRON IZQ./DCHA. 17,2 x 7,3 (10)	7" x 3"	48	0,60	60	13,60	830
CHEVRON IZQ./DCHA. 17,2 x 7,3 (14)	7" x 3"	34	0,43	60	12	735

3DHEX

fine **RESISTANCE**
EVOLUTION
EXTRUDED PORCELAIN TILE

3DHEX

- RESISTENCIA A LA HELADA FROST PROOF
- SUPERFICIE SATINADO GLOSSY SURFACE
- REVESTIMIENTO WALL TILE
- DESTONIFICADO ARMONIOSO CONTROLLED DESTONIFICATION
- SIN MANTENIMIENTO NO MAINTENANCE
- VOLUMEN VOLUME

FORMATOS:
3D HEX. 6,5 x 5,7 - 2,5" x 2,2"
ENM. 3D HEX. 34 x 32,6 - 13,3" x 12,7"

2DHEX

fine **RESISTANCE**
EVOLUTION
EXTRUDED PORCELAIN TILE

2DHEX

- PAVIMENTO DE EXTERIOR OUTDOOR FLOOR TILE
- RESISTENCIA A LA HELADA FROST PROOF
- SUPERFICIE SATINADO GLOSSY SURFACE
- PAVIMENTO DE INTERIOR INDOOR FLOOR TILE
- DESTONIFICADO ARMONIOSO CONTROLLED DESTONIFICATION

FORMATOS:
2D HEX. 13 x 11,4 - 5" x 4"

3DHEX

EVOLUTION EXTRUDED PORCELAIN TILE



3D HEX. SNOW WHITE
6,5 x 5,7 (G 61) 2,5" x 2,2" m²
ENM. 34 x 32,6 (G 66) 13,3" x 12,7" m²



3D HEX. ROPE
6,5 x 5,7 (G 61) 2,5" x 2,2" m²
ENM. 34 x 32,6 (G 66) 13,3" x 12,7" m²



3D HEX. TAN
6,5 x 5,7 (G 61) 2,5" x 2,2" m²
ENM. 34 x 32,6 (G 66) 13,3" x 12,7" m²

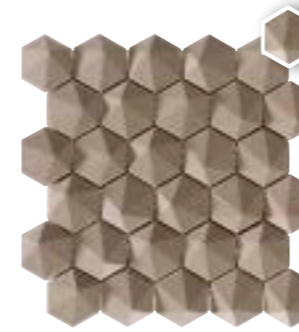

3D HEX. CHESNUT
6,5 x 5,7 (G 61) 2,5" x 2,2" m²
ENM. 34 x 32,6 (G 66) 13,3" x 12,7" m²



3D HEX. ALUMINIUM
6,5 x 5,7 (G 61) 2,5" x 2,2" m²
ENM. 34 x 32,6 (G 66) 13,3" x 12,7" m²

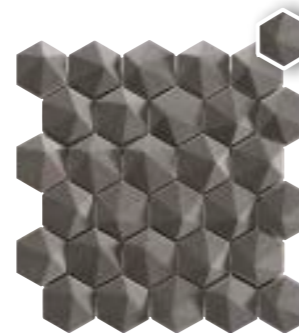

3D HEX. SMOKE
6,5 x 5,7 (G 61) 2,5" x 2,2" m²
ENM. 34 x 32,6 (G 66) 13,3" x 12,7" m²

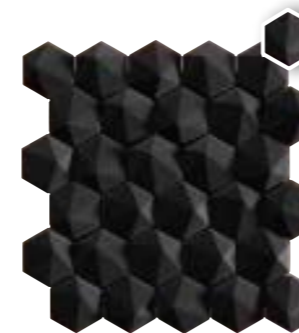

3D HEX. CHARCOAL
6,5 x 5,7 (G 61) 2,5" x 2,2" m²
ENM. 34 x 32,6 (G 66) 13,3" x 12,7" m²

* 3DHEX COLOR ver en pag. 149
3DHEX COLOR see on p. 149

ENMALLADOS PERSONALIZADOS · CUSTOM ON A MESH

Disponible en todos los colores
Available in all colors

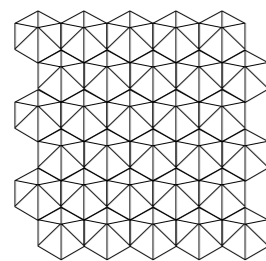

1 COLOR

3D HEX. ENMALLADO
34 x 32,6 (G 66) 13,3" x 12,7" m²

HASTA 3 COLORES

3D HEX. ENMALLADO
34 x 32,6 (G 67) 13,3" x 12,7" m²

MÁS DE 3 COLORES

3D HEX. ENMALLADO
34 x 32,6 (G 49) 13,3" x 12,7" m²

PACKING

FORMATO	PULGADAS	PZ/CAJA	M ²	ML/CAJA	CAJA/PLT	PESO/CAJA	PESO/PLT
HEX. 6,5 x 5,7	2,5" x 2,2"	110	0,41	-	198	6,7	1.342
ENM. 34 x 32,6	13,3" x 12,7"	8	0,89	2,75	36	14,86	549
HEX. 13 x 11,4	5" x 4"	44	0,49	-	120	11,10	1.347

2DHEX

EVOLUTION EXTRUDED PORCELAIN TILE *Comfort floor*



2D HEX SNOW WHITE
13 x 11,4 (G 51) 5" x 4" m²

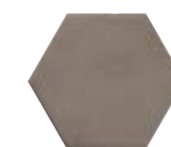

2D HEX GREY
13 x 11,4 (G 51) 5" x 4" m²

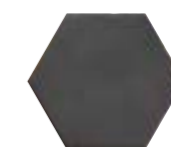

2D HEX CHARCOAL
13 x 11,4 (G 51) 5" x 4" m²

* Disponible en stock Snow White, Grey y Charcoal.
Disponible en otros colores (pedido mínimo 100 m²)
* Available in stock Snow White, Grey and Charcoal.
Available in other colors (minimum order 100 m²)

DUAL

EVOLUTION
EXTRUDED PORCELAIN TILE
EFFECT
MICRO CRAQUELÉ

REVESTIMIENTO
WALL TILE
SUPERFICIE BRILLO
SURFACE BRIGTNES
Pavimento de interior
Indoor floor tiles

RESIST. A LA HELADA
FROST PROOF
SIN MANTENIMIENTO
NO MAINTENANCE

FORMATOS:
HEX. PIATTO 11,7 x 13,5 - 4,6" x 5,3"
HEX. DUAL 11,7 x 13,5 - 4,6" x 5,3"

SHOW

EVOLUTION
EXTRUDED PORCELAIN TILE

REVESTIMIENTO
WALL TILE
SUPERFICIE MATE
MATT SURFACE
SUPERFICIE BRILLO
SURFACE BRIGHTNESS

RESIST. A LA HELADA
FROST PROOF
RESISTENCIA AL RAYADO
SCRATCH RESISTANCE
RESIST. A ÁCIDOS Y BASES
RESIST. TO ACIDS & BASES

PAV. DE INTERIOR
INDOOR FLOOR TILE
SIN MANTENIMIENTO
NO MAINTENANCE
DESTONIFICADO ARMONIOSO
CONTROLLED DESTONIFICATION

FORMATOS:
7,5 x 30 - 3" x 12"
ARROW 7,5 x 25 - 3" x 10"
DART ENM. 29 x 34 - 11,6" x 13,3"



DUAL HEX. PIATTO



DUAL COTTON HEX. PIATTO
11,7 x 13,5 (G 54) 4,6" x 5,3" m



DUAL LATE HEX. PIATTO
11,7 x 13,5 (G 54) 4,6" x 5,3" m



DUAL CENDRE HEX. PIATTO
11,7 x 13,5 (G 54) 4,6" x 5,3" m

DUAL HEX. DUAL



DUAL COTTON HEX. DUAL
11,7 x 13,5 (G 50) 4,6" x 5,3" m



DUAL LATE HEX. DUAL
11,7 x 13,5 (G 50) 4,6" x 5,3" m



DUAL CENDRE HEX. DUAL
11,7 x 13,5 (G 50) 4,6" x 5,3" m

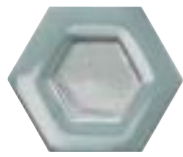

DUAL AQUA HEX. DUAL
11,7 x 13,5 (G 50) 4,6" x 5,3" m



DUAL CAPUCHINO HEX. DUAL
11,7 x 13,5 (G 50) 4,6" x 5,3" m

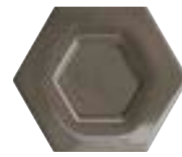

DUAL CHARBON HEX. DUAL
11,7 x 13,5 (G 50) 4,6" x 5,3" m

SHOW ARROW



SHOW ARROW WHITE
7,5 x 25 (G 62) 3" x 10" m



SHOW ARROW BEIGE
7,5 x 25 (G 62) 3" x 10" m



SHOW ARROW GREY
7,5 x 25 (G 62) 3" x 10" m



SHOW ARROW BLACK
7,5 x 25 (G 62) 3" x 10" m

SHOW ARROW



SHOW ARROW GREEN
7,5 x 25 (G 62) 3" x 10" m



SHOW ARROW RED
7,5 x 25 (G 62) 3" x 10" m

PIEZAS ESPECIALES · SPECIAL PIECES

Disponibles en todos los colores · Available in all colors



DEMI-BULLNOSE
1,5 x 30 (G 07) 0,6" x 11,8" m

PACKING

FORMATO	PULGADAS	PZ/CAJA	M ²	CAJA/PLT	PESO/CAJA	PESO/PLT
HEX. PIATTO 11,7 x 13,5	4,6" x 5,3"	40	0,63	66	15,30	1,025
HEX. DUAL 11,7 x 13,5	4,6" x 5,3"	32	0,51	66	12,16	820

PACKING BASES

FORMATO	PULGADAS	PZ/CAJA	M ² /CJ.	ML/CJ.	PS/CJ.	CJ./PLT.	PS/PLT.
7,5 x 25	3" x 10"	22	0,42	5,5	9	120	1,095

PACKING PIEZAS ESPECIALES

FORMATO	PULGADAS	PZ/CAJA	ML/CJ.	PS/CJ.	CJ./PLT.	PS/PLT
DEMI-BULLNOSE 1,5 x 30	0,6" x 11,8"	50	15	2,2		

Provenzal

EVOLUTION
EXTRUDED PORCELAIN TILE

- PAV. DE INTERIOR
INDOOR FLOOR TILE
- SUPERFICIE SATINADO
GLOSSY SURFACE
- SIN MANTENIMIENTO
NO MAINTENANCE

- RESIST. A LA HELADA
FROST PROOF
- DESTONIFICADO ARMONIOSO
CONTROLLED DESTONIFICATION

FORMATOS:
PROVENZAL 10,5 x 6,5 - 4" x 2,5"
PROVENZAL 20,5 x 12 - 8" x 4,7"
PROVENZAL ENM. 38,5 x 42 - 15" x 16,5"

Cammeo

EVOLUTION
EXTRUDED PORCELAIN TILE

- REVESTIMIENTO
WALL TILE
- SUPERFICIE SATINADO
GLOSSY SURFACE
- SIN MANTENIMIENTO
NO MAINTENANCE

- RESIST. A LA HELADA
FROST PROOF
- DESTONIFICADO ARMONIOSO
CONTROLLED DESTONIFICATION

FORMATOS:
ENM. PROVENZAL
38,5 x 42 - 15" x 16,5"



4 TEXTURAS DIFERENTES
4 DIFFERENT TEXTURES



Disponibles en todos los colores · Available in all colors

BASE · BASE

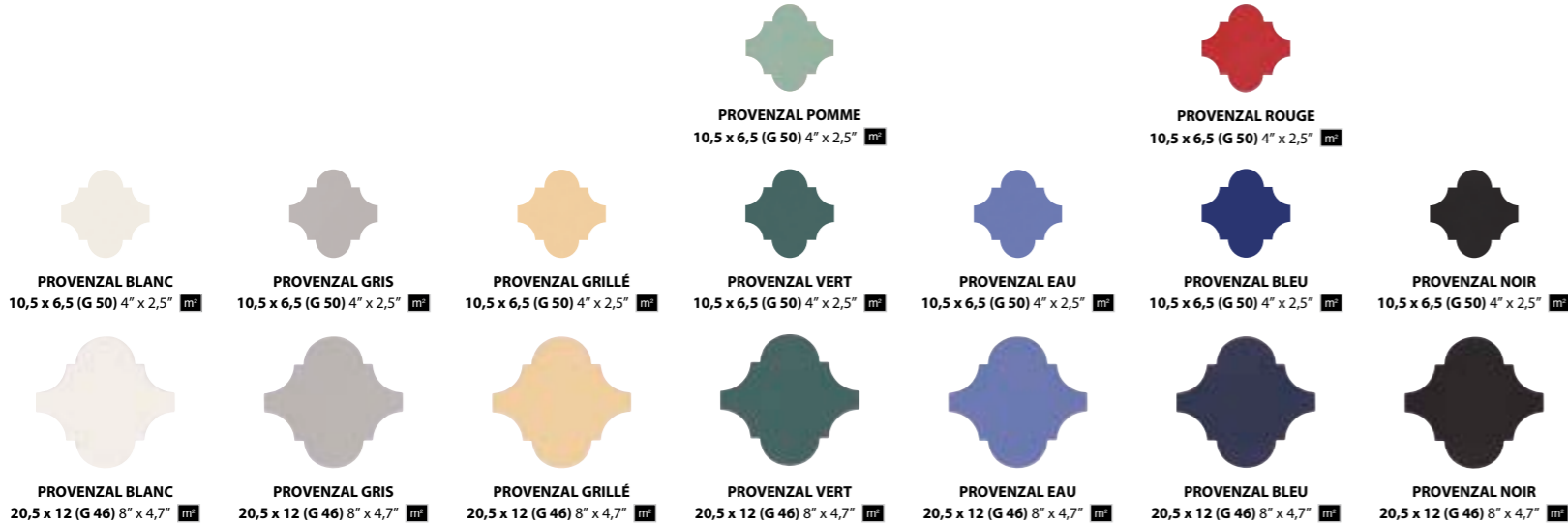

ENMALLADOS · ON A MESH



ENMALLADOS PERSONALIZADOS · CUSTOM ON A MESH

Disponibles en todos los colores · Available in all colors

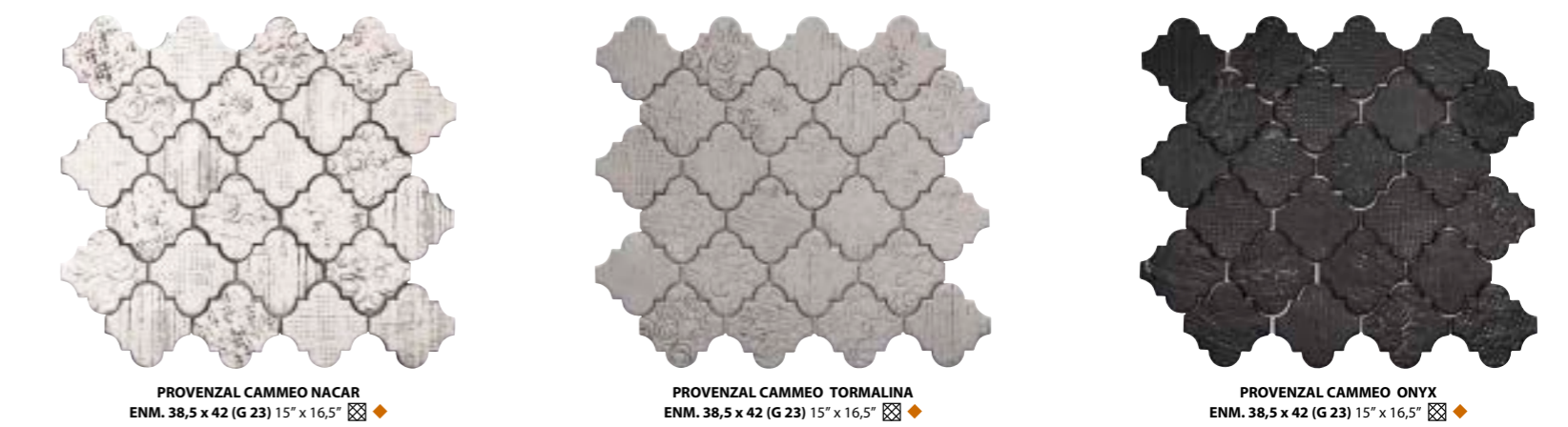
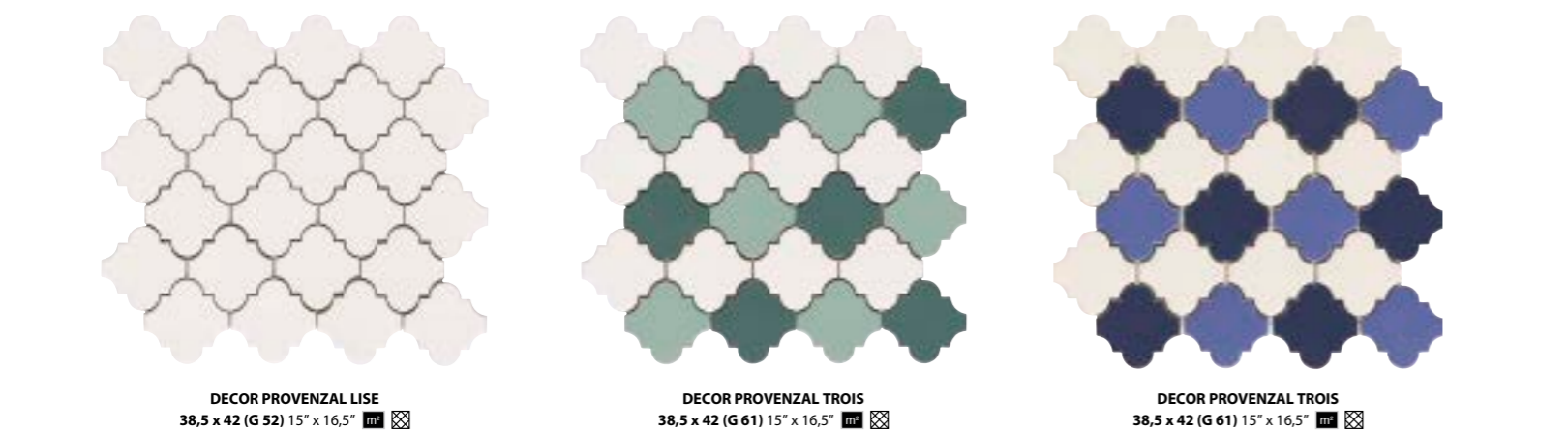

PACKING BASES

FORMATO	PULGADAS	PZ/CAJA	M ²	CAJA/PLT	PESO/CAJA	PESO/PLT
PROVENZAL 10,5 x 6,5	4" x 2,5"	60	0,41	128	8,5	1.102
PROVENZAL 20,5 x 12	8" x 4,7"	24	0,59	60	11,65	713

PACKING BASES

FORMATO	PULGADAS	PZ/CAJA	M ²	CAJA/PLT	PESO/CAJA	PESO/PLT
ENM. 38,5 x 42	15" x 16,5"	7	1,14	40	24,6	998

PACKING BASES

FORMATO	PULGADAS	PZ/CAJA	M ²	CAJA/PLT	PESO/CAJA	PESO/PLT
ENM. PROVENZAL 38,5 x 42	15" x 16,5"	7	1,14	40	24,7	998

NOVECENTO

Pasta Blanca

REVESTIMIENTO
WALL TILE

EFFECT
MICRO CRAQUELE

SUPERFICIE BRILLO
SURFACE BRIGHTNESS

MODULARIDAD
MODULARITY

FORMATO

13 x 39 - 5" x 15"
13 x 13 - 5" x 5"
HEX. 13 x 13 - 5" x 5"
6,5 x 13 - 3" x 5"

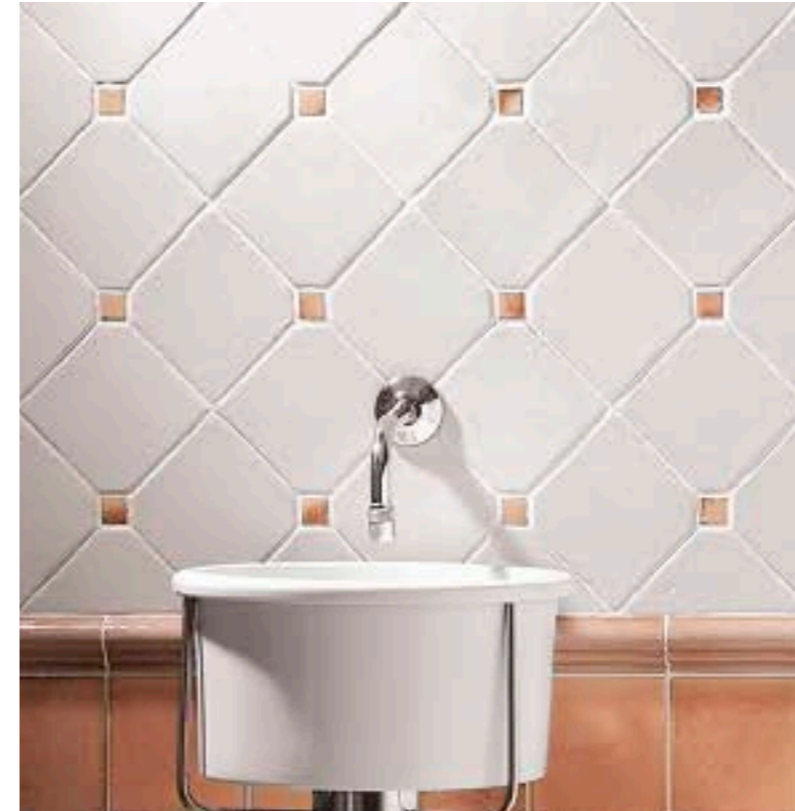

BASE - BASE

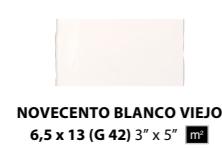

NOVECENTO BLANCO VIEJO
6,5 x 13 (G 42) 3" x 5" m²



NOVECENTO BLANCO VIEJO
13 x 13 (G 42) 5" x 5" m²



HEX. NOVECENTO BLANCO VIEJO
13 x 13 (G 42) 5" x 5" m²



NOVECENTO BLANCO SILENCIO
13 x 13 (G 42) 5" x 5" m²



HEX. NOVECENTO BLANCO SILENCIO
13 x 13 (G 42) 5" x 5" m²



NOVECENTO BLANCO VIEJO
13 x 39 (G 42) 5" x 15" m²



NOVECENTO CANELA
3 x 3 (G 03) 1" x 1" m²



NOVECENTO CANELA
6,5 x 13 (G 42) 3" x 5" m²



NOVECENTO CANELA
13 x 13 (G 42) 5" x 5" m²



NOVECENTO CAMEL
3 x 3 (G 03) 1" x 1" m²



NOVECENTO CAMEL
6,5 x 13 (G 42) 3" x 5" m²



NOVECENTO CAMEL
13 x 13 (G 42) 5" x 5" m²



NOVECENTO BURDEOS
3 x 3 (G 03) 1" x 1" m²

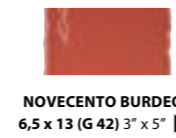

NOVECENTO BURDEOS
6,5 x 13 (G 42) 3" x 5" m²



NOVECENTO BURDEOS
13 x 13 (G 42) 5" x 5" m²

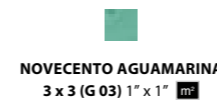

NOVECENTO AGUAMARINA
3 x 3 (G 03) 1" x 1" m²

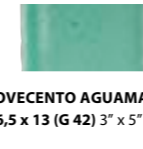

NOVECENTO AGUAMARINA
6,5 x 13 (G 42) 3" x 5" m²



NOVECENTO AGUAMARINA
13 x 13 (G 42) 5" x 5" m²



NOVECENTO VERDÍN
3 x 3 (G 03) 1" x 1" m²



NOVECENTO VERDÍN
6,5 x 13 (G 42) 3" x 5" m²



NOVECENTO VERDÍN
13 x 13 (G 42) 5" x 5" m²

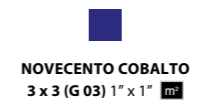

NOVECENTO COBALTO
3 x 3 (G 03) 1" x 1" m²

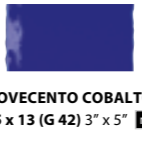

NOVECENTO COBALTO
6,5 x 13 (G 42) 3" x 5" m²



NOVECENTO COBALTO
13 x 13 (G 42) 5" x 5" m²

PIEZAS ESPECIALES - SPECIAL PIECES

Disponible en todos los colores - Available in all colors



TACO NOVECENTO
3 x 3 (G 03) 1" x 1" m²



BORDURA NOVECENTO
4 x 13 (G 10) 2" x 5" m²

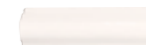

MOLDURA NOVECENTO
5,5 x 13 (G 10) 2" x 5" m²

PACKING BASES

FORMATO	PULGADAS	PZ/CAJA	M ²	CAJA/PLT	PESO/CAJA	PESO/PLT
13 x 39	5" x 15"	20	1	108	19,48	1.192
13 x 13	5" x 5"	30	0,5	102	10,78	1.114
6,5 x 13	3" x 5"	60	0,5	108	11,26	1.257

PACKING PIEZAS ESPECIALES

FORMATO	PULGADAS	PZ/CAJA	ML	CAJA/PLT	PESO/CAJA
TACO 3 x 3	1" x 1"	100	3	150	1,8
BORDURA 4 x 13	2" x 5"	18	2,34	60	1,92
MOLDURA 5,5 x 13	2" x 5"	13	1,69	196	1,53



Natucer ofrece soluciones integrales para piscinas.
Un paquete completo formado por **DOS CONCEPTOS**
diferenciados entre sí.
La fórmula perfecta: dentro y fuera (IN & OUT)

Natucer offers all kind of solutions for
swimming pool projects.
The perfect and most complete concept: IN & OUT

TERRACE + POOL INTERIOR
IN&OUT SOLUTIONS

TIPOS DE PISCINA SEGÚN SU CORONACIÓN · DIFFERENT CROWNING SYSTEM SWIMMING POOLS



Ver serie completa en el catálogo NATURPOOL o en la web <https://www.natucer.es/es/soluciones-ceramicas/soluciones-piscinas>
See complete series in the NATURPOOL catalog or on the web <https://www.natucer.es/en/soluciones-ceramicas/soluciones-piscinas>

CANALIZACIÓN CON GRATTING · GRATTING CHANNEL

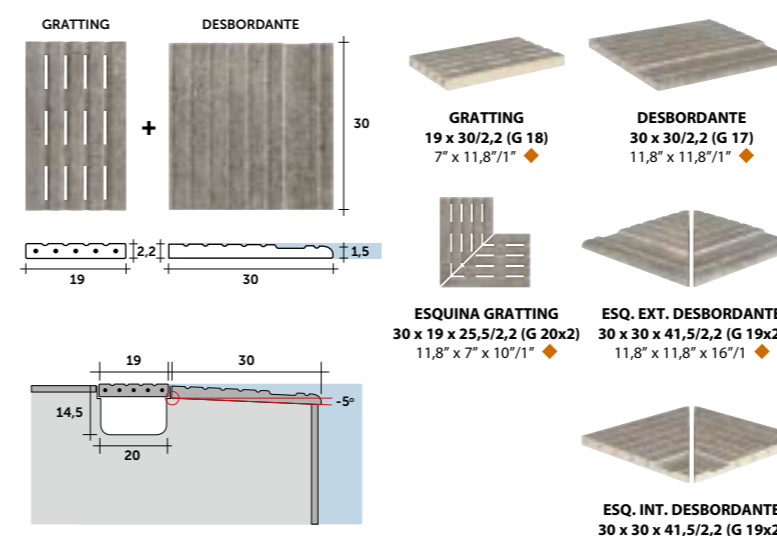

CANALIZACIÓN CON REJILLA · GRILL CHANNEL

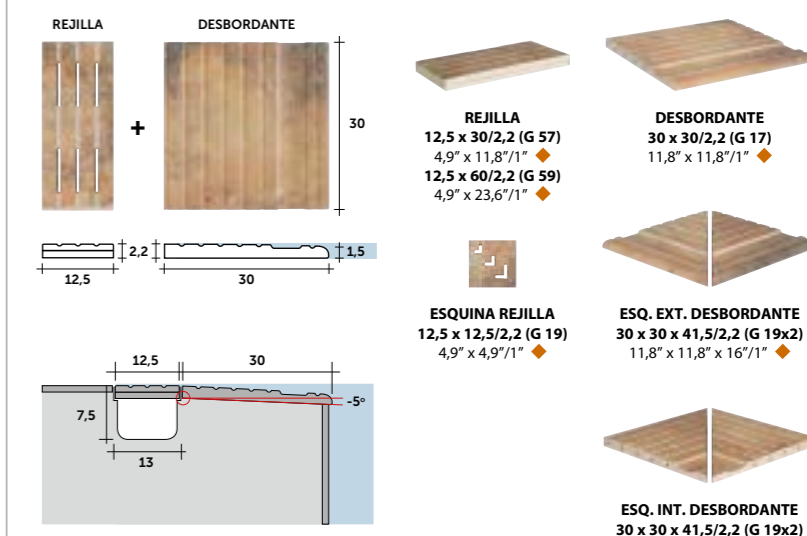



SISTEMA **SKIMMER**
SKIMMER SYSTEM

CORONACIÓN CON
BORDE DE PISCINA
CROWNED WITH POOL BORDER TILES



CORONACIÓN CON BORDE DE PISCINA - CROWNED WITH POOL BORDER TILES

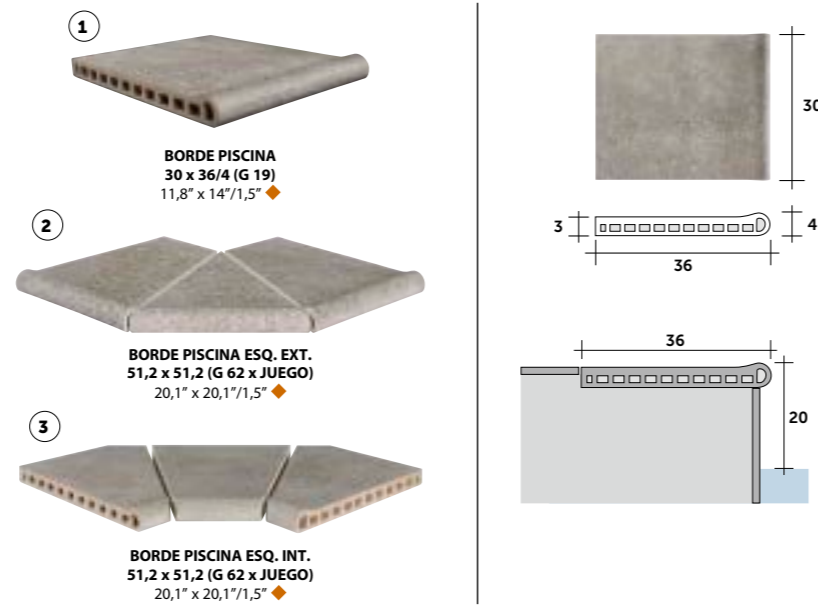

SISTEMA **SKIMMER**
SKIMMER SYSTEM

CORONACIÓN CON
PELDAÑO 120
CROWNED WITH 120 CM STEP



CORONACIÓN CON PELDAÑO 120 - CROWNED WITH 120 CM STEP

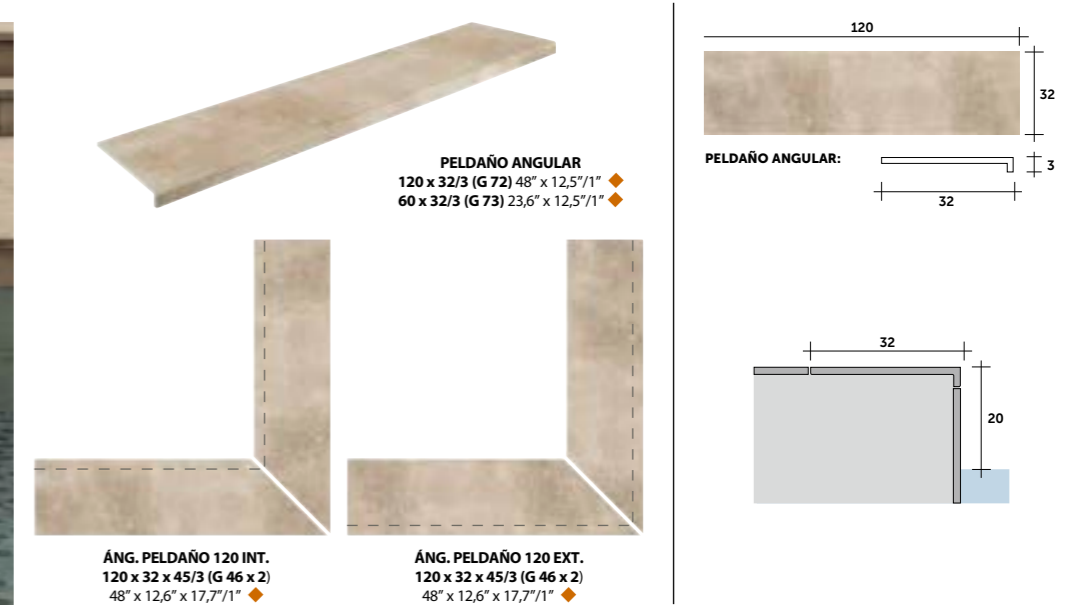

bamboo

EVOLUTION
EXTRUDED PORCELAIN TILE

PE GRES EXTR. PORCELÁNICO
PORCELAIN EXTRUDED TILE

SUPERFICIE BRILLO
SURFACE BRIGTNES

SUPERFICIE MATE
MATT SURFACE

RESIST. A LA HELADA
FROST PROOF

RESIST. A ACIDOS Y BASES
RESIST. TO ACIDS & BASES

SIN MANTENIMIENTO
NO MAINTENANCE

FORMATOS:

8 x 30,5 - 3,1" x 11,9"
8 x 6 - 3,1" x 2,4"
5 x 61 - 2" x 23,8"
5 x 30,5 - 2" x 11,9"

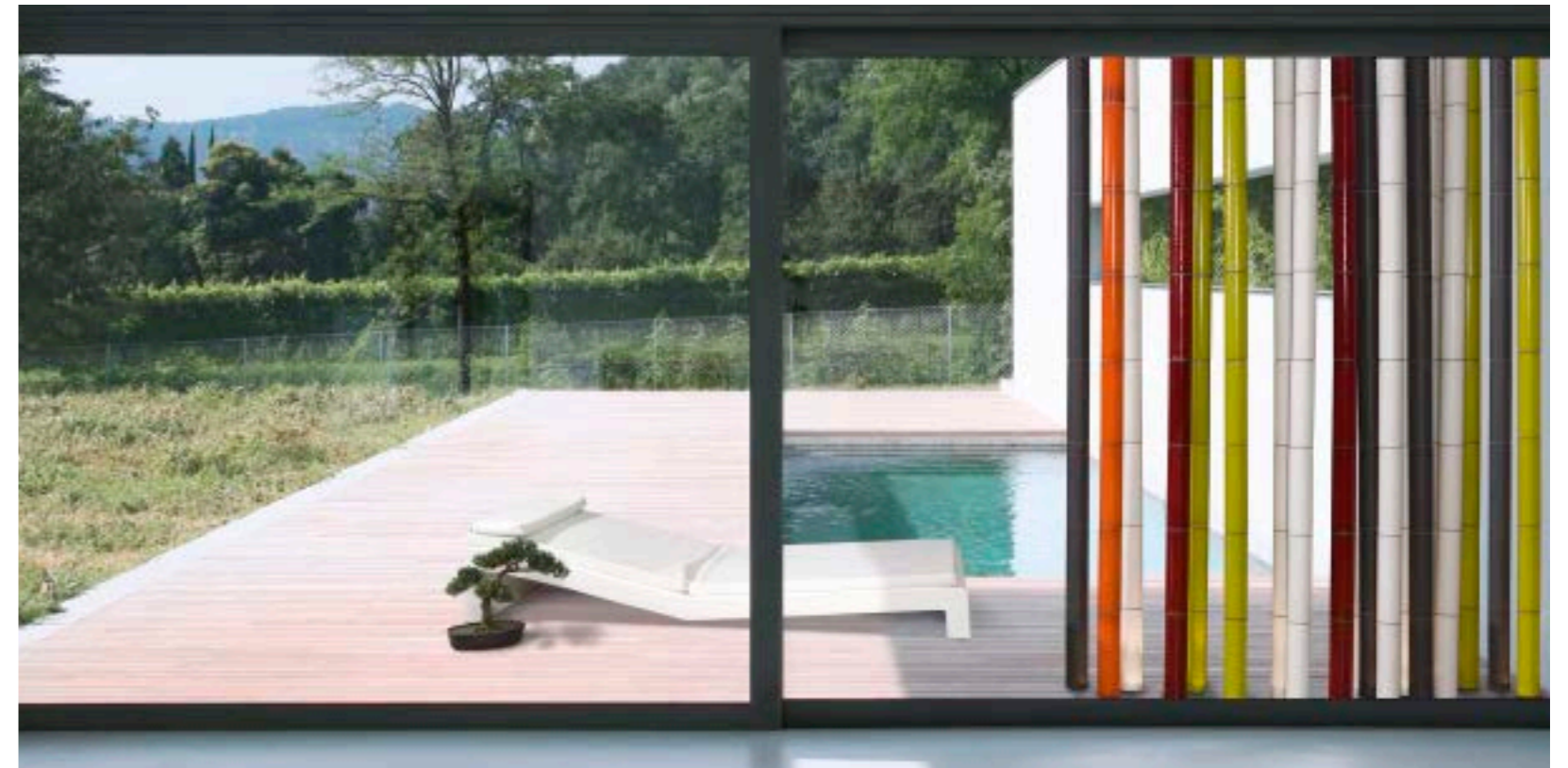

PIEZAS DE 8 CM



COVER BAMBOO FROST
1,5 x 8 (G 15) 1" x 3" ◆



COVER BAMBOO YOLK
1,5 x 8 (G 15) 1" x 3" ◆



COVER BAMBOO RUBI
1,5 x 8 (G 15) 1" x 3" ◆



COVER BAMBOO GEM
1,5 x 8 (G 15) 1" x 3" ◆



COVER BAMBOO DARK
1,5 x 8 (G 15) 1" x 3" ◆



BAMBOO FROST
8 x 30,5 (G 31) 3,1" x 11,9" ◆



BAMBOO YOLK
8 x 30,5 (G 17) 3,1" x 11,9" ◆



BAMBOO RUBI
8 x 30,5 (G 17) 3,1" x 11,9" ◆



BAMBOO GEM
8 x 30,5 (G 17) 3,1" x 11,9" ◆



BAMBOO DARK
8 x 30,5 (G 31) 3,1" x 11,9" ◆



BAMBOO FROST
8 x 6 (G 10) 3,1" x 2,4" ◆



BAMBOO YOLK
8 x 6 (G 11) 3,1" x 2,4" ◆



BAMBOO RUBI
8 x 6 (G 11) 3,1" x 2,4" ◆



BAMBOO GEM
8 x 6 (G 11) 3,1" x 2,4" ◆



BAMBOO DARK
8 x 6 (G 10) 3,1" x 2,4" ◆



BAMBOO METAL
2 x 8 (G 16) 1" x 3" ◆

ALZADO RAISED

Montaje interior
inside installation



cover (15 mm.)
tapa superior

tubo (35 mm.)

arandella intermedia

60

72

49,5

Tapa superior
Top cover

Arandella intermedia
Shim

72

48

PACKING BASES

FORMATO	PULGADAS	M ² /CAJA	ML / CAJA	PIEZAS / CAJA	KG / PIEZA	KG / CAJA	CAJAS / PALET	KG / PALET
BAMBOO 8 x 30,5	3,1" x 11,9"	0,613	2,44	8	2,5	20	28	586
BAMBOO 8 x 6	3,1" x 2,4"	0,12	0,96	16	0,25	4	60	250
COVER 1,5 x 8	1" x 3"	0,03	2	25	0,14	3,6	60	230

PACKING BASES

FORMATO	PULGADAS	M ² /CAJA	ML / CAJA	PIEZAS / CAJA	KG / PIEZA	KG / CAJA	CAJAS / PALET	KG / PALET
BAMBOO 5 x 61	2" x 23,8"	0,574	3,66	6	2,31	13,86	36	520
BAMBOO 5 x 30,5	2" x 11,9"	0,287	5,49	18	1,11	20	28	580
BAMBOO 5 x 3,2	2" x 1,2"	0,04	1,25	25	0,11	2,85	60	200
COVER 1,4 x 5	1" x 2"	0,02	1,25	25	0,052	1,4	60	200

PIEZAS DE 5 CM



COVER BAMBOO FROST
1,4 x 5 (G 14) 1" x 2" ◆



COVER BAMBOO YOLK
1,4 x 5 (G 14) 1" x 2" ◆



COVER BAMBOO RUBI
1,4 x 5 (G 14) 1" x 2" ◆



COVER BAMBOO GEM
1,4 x 5 (G 14) 1" x 2" ◆



COVER BAMBOO DARK
1,4 x 5 (G 14) 1" x 2" ◆



BAMBOO FROST
5 x 61 (G 17) 2" x 23,8" ◆



BAMBOO YOLK
5 x 61 (G 19) 2" x 23,8" ◆



BAMBOO RUBI
5 x 61 (G 19) 2" x 23,8" ◆



BAMBOO GEM
5 x 61 (G 19) 2" x 23,8" ◆



BAMBOO DARK
5 x 61 (G 17) 2" x 23,8" ◆



BAMBOO FROST
3,2 x 5 (G 06) 1,2" x 2" ◆



BAMBOO YOLK
3,2 x 5 (G 08) 1,2" x 2" ◆



BAMBOO RUBI
3,2 x 5 (G 08) 1,2" x 2" ◆



BAMBOO GEM
3,2 x 5 (G 08) 1,2" x 2" ◆



BAMBOO DARK
3,2 x 5 (G 06) 1,2" x 2" ◆

ALZADO RAISED

Montaje interior
inside installation



cover (15 mm.)
tapa superior

tubo (35 mm.)

arandella intermedia

610

30

50

Arandella intermedia
Shim

45

22

37

18

32

cube

EVOLUTION
EXTRUDED PORCELAIN TILE

GRES EXTR. PORCELÁNICO
PORCELAIN EXTRUDED TILE

SUPERFICIE BRILLO
SURFACE BRIGTNES

SUPERFICIE MATE
MATT SURFACE

RESIST. A LA HELADA
FROST PROOF

RESIST. A ÁCIDOS Y BASES
RESIST. TO ACIDS & BASES

SIN MANTENIMIENTO
NO MAINTENANCE

FORMATOS:

8 x 30,5 - 3,1" x 11,9"
8 x 6 - 3,1" x 2,4"
5 x 61 - 2" x 23,8"
5 x 30,5 - 2" x 11,9"

bamboo & cube

KIT DE MONTAJE INSTALLATION KIT



KIT DE MONTAJE HORIZONTAL con tubo de acero inoxidable HORIZONTAL INSTALLATION KIT with stainless steel stick

Bamboo & Cube

MONTAJE HORIZONTAL 5 cm. HORIZONTAL INSTALLATION WITH 5 cm

- Incluido en el KIT. Solicitar presupuesto**
Included in the KIT. Request budgest
- 1.-Taco pared (2 unidades)
Taco wall (2 units)
 - 2.-Tornillo pared (2 unidades)
Top wall (2 units)
 - 3.-Embelecedor (2 unidades) (para Bamboo)
Trim (2 units)
 - 3.-Embelecedor (2 unidades) (para Cube)
Trim (2 units)
 - 4.-Tornillo prisionero (2 unidades)
Setscrew (2 units)

No incluido en el KIT
Not included in the KIT

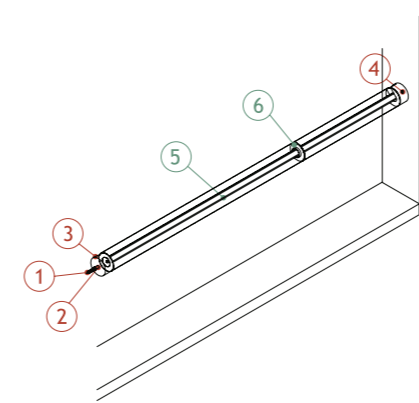

5.-Tubo cuadrado 16x16 mm.
16x16 mm. square tube

6.-Arandela intermedia (para Bamboo)
Shim

6.-Arandela intermedia (para Cube)
Shim

REFERENCIA	CARACTERÍSTICAS	Nº PIEZAS NECESARIAS (NO INCLUIDAS EN KIT)
TUBO HORIZONTAL BAMBOO 5 cm. 122	Tubo cuadrado de 16x16 mm. mecanizado, con una altura de 1,225 metros.	x2 + x1 x4 + x3
TUBO HORIZONTAL BAMBOO 5 cm. 153	Tubo cuadrado de 16x16 mm. mecanizado, con una altura de 1,530 metros.	x2 + x1 + x2 x5 + x4
TUBO HORIZONTAL BAMBOO 5 cm. 183	Tubo cuadrado de 16x16 mm. mecanizado, con una altura de 1,835 metros.	x3 + x2 x6 + x5

RELACION ALTIMA DE PIEZAS · HIGH SIZES OF THE PIECE

CUBE	BAMBOO	BAMBOO
4,2x61 cm.	5x61 cm.	5x30,5 cm.
5x61 cm. = equivale a 2 = 5x30,5 cm.		
x 10 Pack de 10 arandelas intermedias Grosor 1mm (para Bamboo)		
x 10 Pack de 10 arandelas intermedias Grosor 1mm (para Cube)		

PIEZAS DE 5 CM



ALZADO RAISED

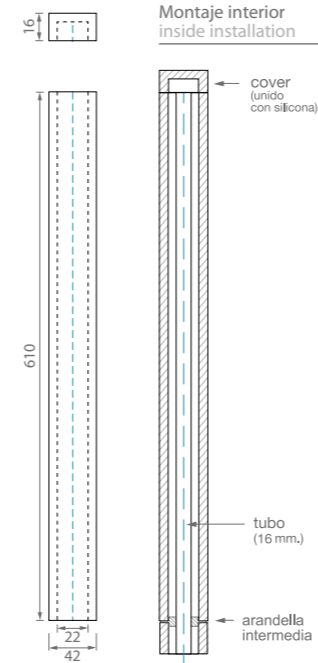

Arandela intermedia Shim

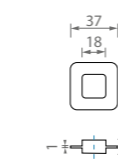

MÚLTIPLES APLICACIONES
VARIOUS APPLICATIONS

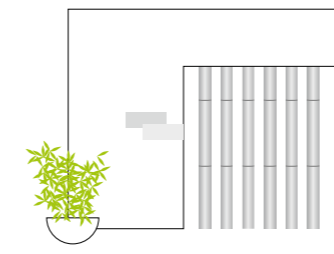

APLICACIÓN EN FACHADAS
FACADE APPLICATION

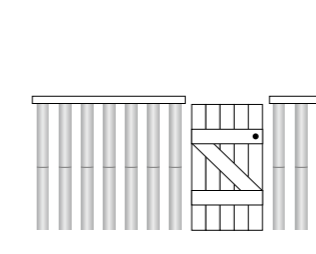

APLICACIÓN EN JARDINES Y EXTERIORES
GARDENS AND EXTERIORS APPLICATIONS

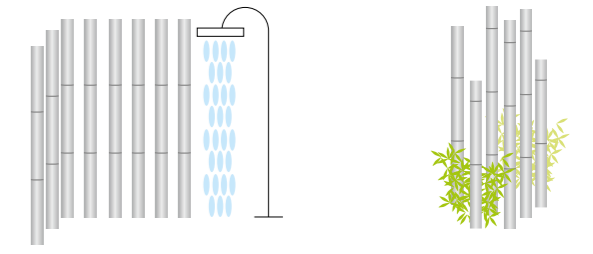

APLICACIÓN EN SEPARADORES DE AMBIENTES
AMBIANCES SEPARATORS APPLICATIONS

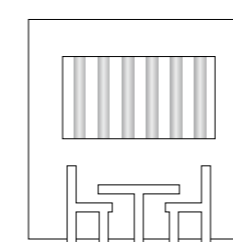

APLICACIÓN EN VENTANAS Y TERRAZAS
WINDOWS AND TERRACES APPLICATIONS

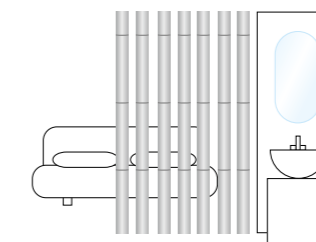

APLICACIÓN EN SEPARADORES DE AMBIENTES
AMBIANCES SEPARATORS APPLICATIONS

PACKING BASES

FORMATO	PULGADAS	M ² /CAJA	ML / CAJA	PIEZAS/CAJA	KG / PIEZA	KG / CAJA	CAJAS/PALET	KG / PALET
CUBE 4,2 x 61	2" x 23,8"	0,615	3,6	6	2,4	14,4	36	530
CUBE 4,2 x 2,4	2" x 1"	0,025	1,05	25	0,095	2,48	60	160
COVER 1,6 x 4,2	1" x 2"	0,017	1,05	25	0,052	1,4	60	98

MONTAJE LIBRE FREE INSTALLATION

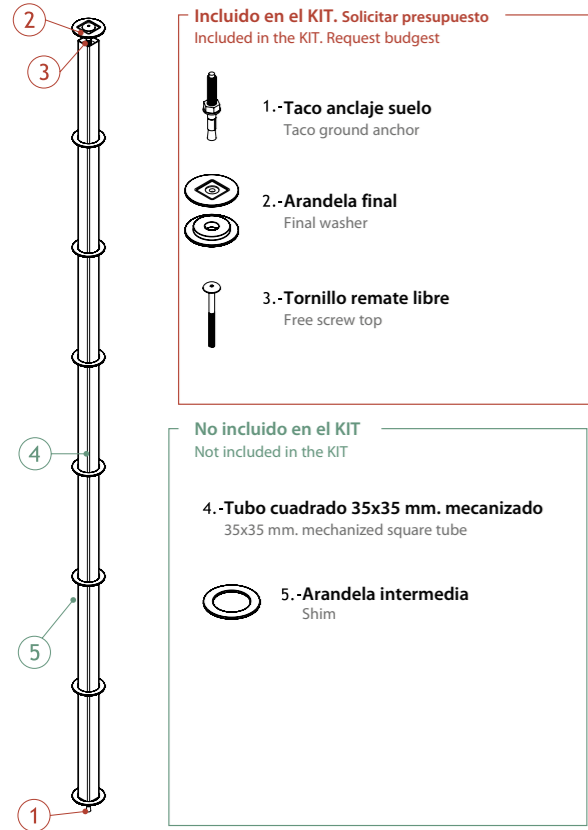

Incluido en el KIT. Solicitar presupuesto
Included in the KIT. Request budget

1.-Taco anclaje suelo
Taco ground anchor

2.-Arandela final
Final washer

3.-Tornillo remate libre
Free screw top

No incluido en el KIT
Not included in the KIT

4.-Tubo cuadrado 35x35 mm. mecanizado
35x35 mm. mechanized square tube

5.-Arandela intermedia
Shim

REFERENCIA	CARACTERÍSTICAS	ALTURA (SUMA PIEZAS Y ARANDELAS)	Nº PIEZAS NECESARIAS (NO INCLUIDAS EN KIT)	ARANDELA (INCLUIDA)
TUBO VERTICAL BAMBOO 8 cm. 150	Tubo cuadrado de 35x35 mm. mecanizado, con una altura de 1,500 metros.	Cortando 1,500 metros.	4 + 1 [h: 26,5cm.] + 5	X1
		Desde 1,540 metros.	5 + 5	X1
		Hasta 1,573 metros.	5 + 1 [h: 3cm.] + 6	X1
TUBO VERTICAL BAMBOO 8 cm. 180	Tubo cuadrado de 35x35 mm. mecanizado, con una altura de 1,805 metros.	Cortando 1,808 metros.	5 + 1 [h: 26,5cm.] + 6	X1
		Desde 1,848 metros.	6 + 6	X1
		Hasta 1,881 metros.	6 + 1 [h: 3cm.] + 7	X1
TUBO VERTICAL BAMBOO 8 cm. 211	Tubo cuadrado de 35x35 mm. mecanizado, con una altura de 2,115 metros.	Cortando 2,121 metros.	6 + 1 [h: 27cm.] + 7	X1
		Desde 2,156 metros.	7 + 7	X1
		Hasta 2,189 metros.	7 + 1 [h: 3cm.] + 8	X1
TUBO VERTICAL BAMBOO 8 cm. 242	Tubo cuadrado de 35x35 mm. mecanizado, con una altura de 2,425 metros.	Cortando 2,429 metros.	7 + 1 [h: 27cm.] + 8	X1
		Desde 2,464 metros.	8 + 8	X1
		Hasta 2,497 metros.	8 + 1 [h: 3cm.] + 9	X1
TUBO VERTICAL BAMBOO 8 cm. 273	Tubo cuadrado de 35x35 mm. mecanizado, con una altura de 2,730 metros.	Cortando 2,737 metros.	8 + 1 [h: 27cm.] + 9	X1
		Desde 2,772 metros.	9 + 9	X1
		Hasta 2,805 metros.	9 + 1 [h: 3cm.] + 10	X1
RELACIÓN ALTURA DE PIEZAS - HIGH SIZES OF THE PIECE				
BAMBOO 8x30,5 cm.	8x30,5 cm. = equivale a 5 = 8x6 cm.			BAMBOO 8x6 cm.

x 10 Pack de 10 arandelas intermedias Grosor 1mm

MONTAJE LIBRE FREE INSTALLATION

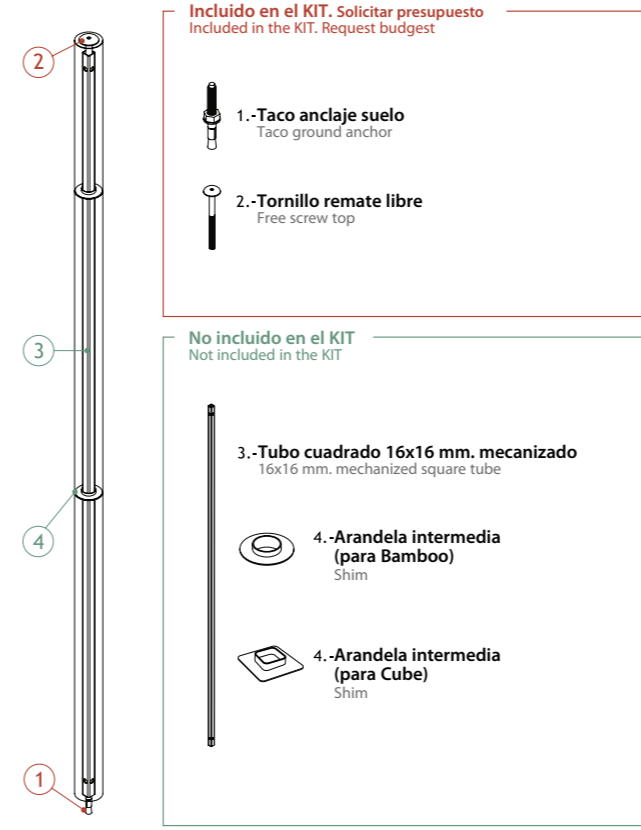

Incluido en el KIT. Solicitar presupuesto
Included in the KIT. Request budget

1.-Taco anclaje suelo
Taco ground anchor

2.-Tornillo remate libre
Free screw top

No incluido en el KIT
Not included in the KIT

3.-Tubo cuadrado 16x16 mm. mecanizado
16x16 mm. mechanized square tube

4.-Arandela intermedia (para Bamboo)
Shim

4.-Arandela intermedia (para Cube)
Shim

REFERENCIA	CARACTERÍSTICAS	ALTURA (SUMA PIEZAS Y ARANDELAS)	Nº PIEZAS NECESARIAS (NO INCLUIDAS EN KIT)
TUBO VERTICAL BAMBOO 5 cm. 150	Tubo cuadrado de 16x16 mm. mecanizado, con una altura de 1,500 metros.	Desde 1,527 metros.	2 + 1 + 2
		Hasta 1,529 metros.	5 + 4
TUBO VERTICAL BAMBOO 5 cm. 180	Tubo cuadrado de 16x16 mm. mecanizado, con una altura de 1,805 metros.	Desde 1,832 metros.	3 + 2 + 2
		Hasta 1,835 metros.	6 + 5
TUBO VERTICAL BAMBOO 5 cm. 211	Tubo cuadrado de 16x16 mm. mecanizado, con una altura de 2,115 metros.	Desde 2,138 metros.	3 + 1 + 3
		Hasta 2,141 metros.	7 + 6
TUBO VERTICAL BAMBOO 5 cm. 242	Tubo cuadrado de 16x16 mm. mecanizado, con una altura de 2,425 metros.	Desde 2,443 metros.	4 + 3 + 3
		Hasta 2,447 metros.	8 + 7
TUBO VERTICAL BAMBOO 5 cm. 273	Tubo cuadrado de 16x16 mm. mecanizado, con una altura de 2,730 metros.	Desde 2,749 metros.	4 + 1 + 4
		Hasta 2,753 metros.	9 + 8
RELACIÓN ALTURA DE PIEZAS - HIGH SIZES OF THE PIECE			
CUBE 4,2x61 cm.	BAMBOO 5x61 cm.	5x61 cm. = equivale a 2 = 5x30,5 cm.	

x 10 Pack de 10 arandelas intermedias Grosor 1mm (para Bamboo)

x 10 Pack de 10 arandelas intermedias Grosor 1mm (para Cube)

MONTAJE A TECHO INSTALLATION TO THE ROOF

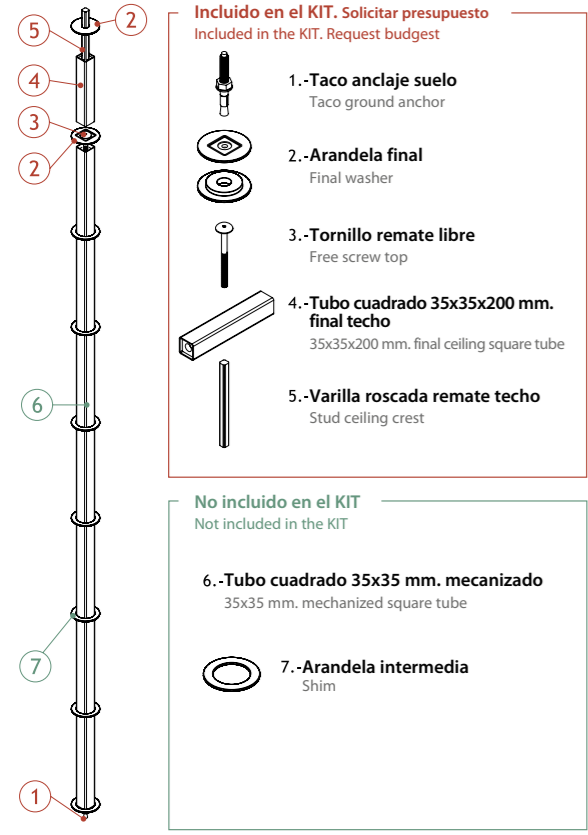

Incluido en el KIT. Solicitar presupuesto
Included in the KIT. Request budget

1.-Taco anclaje suelo
Taco ground anchor

2.-Arandela final
Final washer

3.-Tornillo remate libre
Free screw top

4.-Tubo cuadrado 35x35x200 mm. final techo
35x35x200 mm. final ceiling square tube

5.-Varilla roscada remate techo
Stud ceiling crest

No incluido en el KIT
Not included in the KIT

6.-Tubo cuadrado 35x35 mm. mecanizado
35x35 mm. mechanized square tube

7.-Arandela intermedia
Shim

REFERENCIA	CARACTERÍSTICAS	ALTURA (SUMA PIEZAS Y ARANDELAS)	Nº PIEZAS NECESARIAS (NO INCLUIDAS EN KIT)	ARANDELA (INCLUIDA)
TUBO VERTICAL BAMBOO 8 cm. 150	Tubo cuadrado de 35x35 mm. mecanizado, con una altura de 1,500 metros.	Cortando 1,808 metros.	5 + 1 [h: 26,5cm.] + 6	X1
		Desde 1,848 metros.	6 + 6	X1
		Hasta 1,881 metros.	6 + 1 [h: 3cm.] + 7	X1
TUBO VERTICAL BAMBOO 8 cm. 180	Tubo cuadrado de 35x35 mm. mecanizado, con una altura de 1,805 metros.	Cortando 2,121 metros.	6 + 1 [h: 27cm.] + 7	X1
		Desde 2,156 metros.	7 + 7	X1
		Hasta 2,189 metros.	7 + 1 [h: 3cm.] + 8	X1
TUBO VERTICAL BAMBOO 8 cm. 211	Tubo cuadrado de 35x35 mm. mecanizado, con una altura de 2,115 metros.	Cortando 2,429 metros.	7 + 1 [h: 27cm.] + 8	X1
		Desde 2,464 metros.	8 + 8	X1
		Hasta 2,497 metros.	8 + 1 [h: 3cm.] + 9	X1
TUBO VERTICAL BAMBOO 8 cm. 242	Tubo cuadrado de 35x35 mm. mecanizado, con una altura de 2,425 metros.	Cortando 2,737 metros.	8 + 1 [h: 27cm.] + 9	X1
		Desde 2,772 metros.	9 + 9	X1
		Hasta 2,805 metros.	9 + 1 [h: 3cm.] + 10	X1
TUBO VERTICAL BAMBOO 8 cm. 273	Tubo cuadrado de 35x35 mm. mecanizado, con una altura de 2,730 metros.	Cortando 3,045 metros.	9 + 1 [h: 27cm.] + 10	X1
		Desde 3,080 metros.	10 + 10	X1
		Hasta 3,113 metros.	10 + 1 [h: 3cm.] + 10	X1
RELACIÓN ALTURA DE PIEZAS - HIGH SIZES OF THE PIECE				
BAMBOO 8x30,5 cm.	8x30,5 cm. = equivale a 5 = 8x6 cm.			BAMBOO 8x6 cm.

x 10 Pack de 10 arandelas intermedias Grosor 1mm

MONTAJE A TECHO INSTALLATION TO THE ROOF

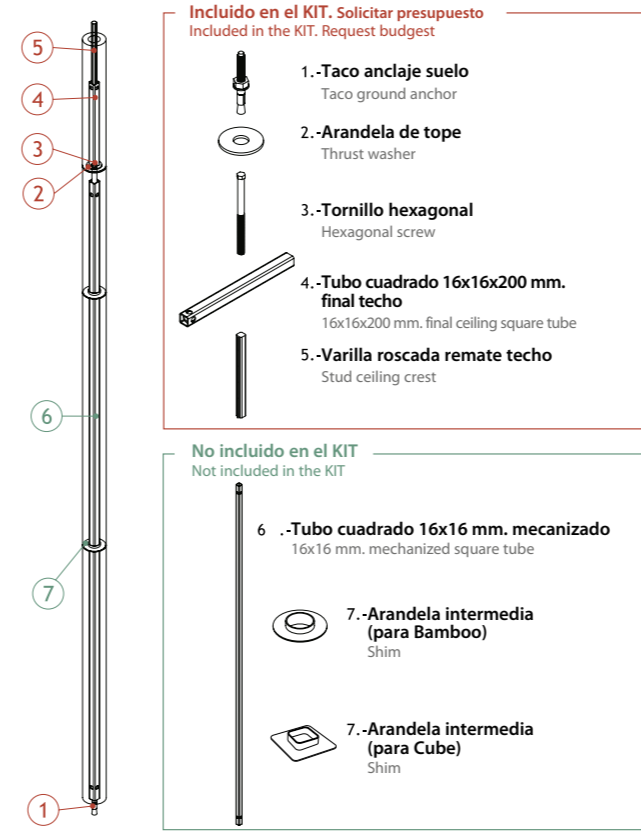

Incluido en el KIT. Solicitar presupuesto
Included in the KIT. Request budget

1.-Taco anclaje suelo
Taco ground anchor

2.-Arandela de tope
Thrust washer

3.-Tornillo hexagonal
Hexagonal screw

4.-Tubo cuadrado 16x16x200 mm. final techo
16x16x200 mm. final ceiling square tube

5.-Varilla roscada remate techo
Stud ceiling crest

No incluido en el KIT
Not included in the KIT

6.-Tubo cuadrado 16x16 mm. mecanizado
16x16 mm. mechanized square tube

7.-Arandela intermedia (para Bamboo)
Shim

7.-Arandela intermedia (para Cube)
Shim

REFERENCIA	CARACTERÍSTICAS	ALTURA (SUMA PIEZAS Y ARANDELAS)	Nº PIEZAS NECESARIAS (NO INCLUIDAS EN KIT)
TUBO VERTICAL BAMBOO 5 cm. 150	Tubo cuadrado de 16x16 mm. mecanizado, con una altura de 1,500 metros.	Cortando 1,796 metros.	5 + 1 [h: 26,5cm.] + 6
		Desde 1,836 metros.	6 + 6
		Hasta 1,867 metros.	6 + 1 [h: 3cm.] + 7
TUBO VERTICAL BAMBOO 5 cm. 180	Tubo cuadrado de 16x16 mm. mecanizado, con una altura de 1,805 metros.	Cortando 2,102 metros.	6 + 1 [h: 26,5cm.] + 7
		Desde 2,142 metros.	7 + 7
		Hasta 2,173 metros.	7 + 1 [h: 3cm.] + 8
TUBO VERTICAL BAMBOO 5 cm. 211	Tubo cuadrado de 16x16 mm. mecanizado, con una altura de 2,115 metros.	Cortando 2,408 metros.	7 + 1 [h: 26,5cm.] + 8
		Desde 2,448 metros.	8 + 8
		Hasta 2,479 metros.	8 + 1 [h: 3cm.] + 9
TUBO VERTICAL BAMBOO 5 cm. 242	Tubo cuadrado de 16x16 mm. mecanizado, con una altura de 2,425 metros.	Cortando 2,714 metros.	8 + 1 [h: 26,5cm.] + 9
		Desde 2,754 metros.	9 + 9
		Hasta 2,785 metros.	9 + 1 [h: 3cm.] + 10
TUBO VERTICAL BAMBOO 5 cm. 273	Tubo cuadrado de 16x16 mm. mecanizado, con una altura de 2,730 metros.	Cortando 3,020 metros.	9 + 1 [h: 26,5cm.] + 10
		Desde 3,060 metros.	10 + 10
		Hasta 3,091 metros.	10 + 1 [h: 3cm.] + 11
RELACIÓN ALTURA DE PIEZAS - HIGH SIZES OF THE PIECE			
CUBE 4,2x61 cm.	BAMBOO 5x61 cm.	5x61 cm. = equivale a 2 = 5x30,5 cm.	

x 10 Pack de 10 arandelas intermedias Grosor 1mm (para Bamboo)

x 10 Pack de 10 arandelas intermedias Grosor 1mm (para Cube)

DYNAMIC

EVOLUTION
EXTRUDED PORCELAIN TILE

PE GRES EXTR. PORCELÁNICO
PORCELAIN EXTRUDED TILE

REVESTIMIENTO
WALL TILE

SIN MANTENIMIENTO
NO MAINTENANCE

SUPERFICIE MATE
MATT SURFACE

RESIST. A LA HELADA
FROST PROOF

RESIST. A ÁCIDOS Y BASES
RESIST. TO ACIDS & BASES

FORMATOS:
7,5 x 30 - 3" x 12"
CUBIK 26 x 30 - 10,1" x 12"
ARCH 15 x 30 - 6" x 12"
ANGLE 12,5 x 30 - 5" x 12"
LANCE 10 x 30 - 3,9" x 12"
BLOCK 10 x 30 - 3,9" x 12"



DYNAMIC LANCE



ESTE PRODUCTO PERMITE DIFERENTES COLOCACIONES:
THIS PRODUCT ALLOWS DIFFERENT PLACEMENTS:

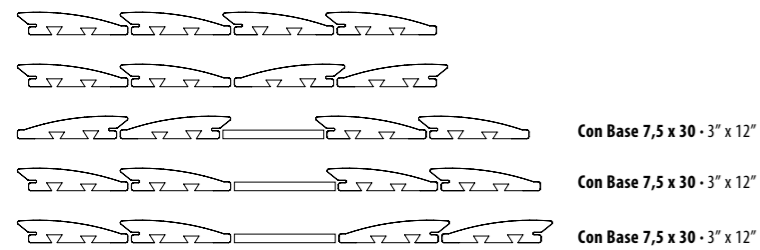

PERFIL PROFILE

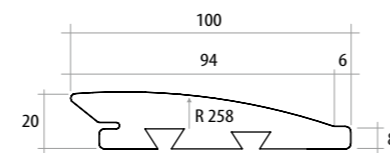

DYNAMIC BLOCK



ESTE PRODUCTO PERMITE DIFERENTES COLOCACIONES:
THIS PRODUCT ALLOWS DIFFERENT PLACEMENTS:

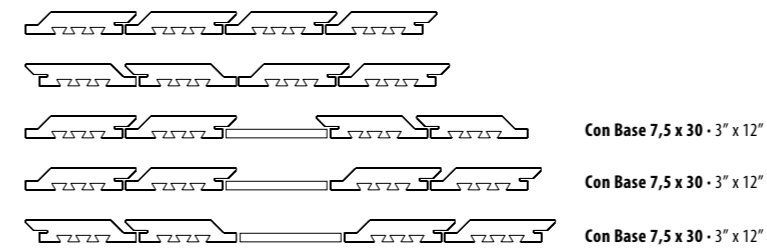

PERFIL PROFILE

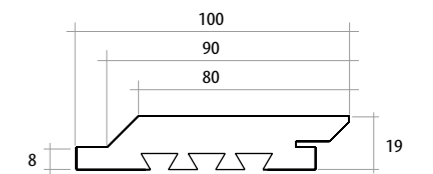

PACKING BASES

FORMATO	PULGADAS	PZ/CAJA	M ²	CAJA/PLT	PESO/CAJA	PESO/PLT
LANCE 10 x 30	3,9" x 12"	24	0,725	24	22,8	565

PACKING BASES

FORMATO	PULGADAS	PZ/CAJA	M ²	CAJA/PLT	PESO/CAJA	PESO/PLT
BLOCK 10 x 30	3,9" x 12"	24	0,725	24	21,5	530

DYNAMIC

EVOLUTION
EXTRUDED PORCELAIN TILE

PE GRES EXTR. PORCELÁNICO
PORCELAIN EXTRUDED TILE

REVESTIMIENTO
WALL TILE

SIN MANTENIMIENTO
NO MAINTENANCE

SUPERFICIE MATE
MATT SURFACE

RESIST. A LA HELADA
FROST PROOF

RESIST. A ÁCIDOS Y BASES
RESIST. TO ACIDS & BASES

FORMATOS:
7,5 x 30 - 3" x 12"
CUBIK 26 x 30 - 10,1" x 12"
ARCH 15 x 30 - 6" x 12"
ANGLE 12,5 x 30 - 5" x 12"
LANCE 10 x 30 - 3,9" x 12"
BLOCK 10 x 30 - 3,9" x 12"



BASE LISA · SMOOTH BASE

BASES COMBINABLES SERIE ART
COMBINABLE BASES

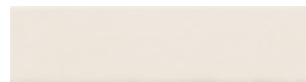

DYNAMIC WHITE
7,5 x 30 (G 59) 3" x 12" **mt**

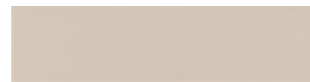

ART ROPE 10
7,5 x 30 (G 59) 3" x 12" **mt**

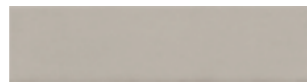

ART ALUMINIUM 10
7,5 x 30 (G 59) 3" x 12" **mt**

DYNAMIC CUBIK

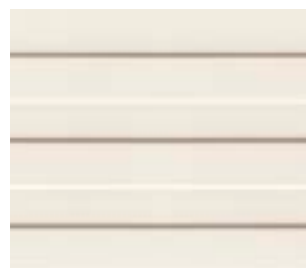

DYNAMIC CUBIK FROST
26 x 30 (G 65) 10,1" x 12" **mt**



DYNAMIC CUBIK GRIZZLY
26 x 30 (G 65) 10,1" x 12" **mt**

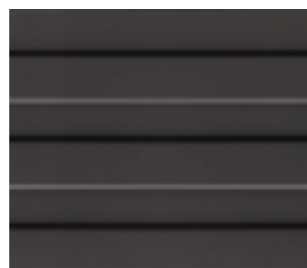

DYNAMIC CUBIK DARK
26 x 30 (G 65) 10,1" x 12" **mt**



PERFIL PROFILE

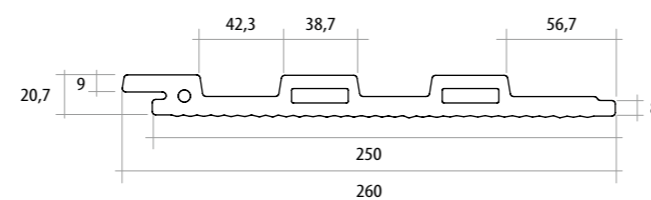

ESTE PRODUCTO PERMITE DIFERENTES COLOCACIONES:
THIS PRODUCT ALLOWS DIFFERENT PLACEMENTS:

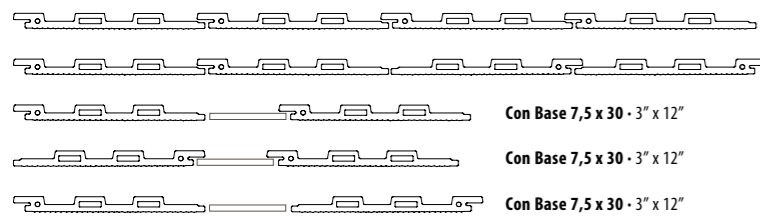

PACKING BASES

FORMATO	PULGADAS	PZ/CAJA	M ²	CAJA/PLT	PESO/CAJA	PESO/PLT
7,5 x 30	3" x 12"	22	0,5	120	10,44	1,268
CUBIK 26 x 30	10,1" x 12"	8	0,625	24	18,15	450

DYNAMIC ARCH



DYNAMIC ARCH FROST
15 x 30 (G 51) 6" x 12" **mt**



DYNAMIC ARCH GRIZZLY
15 x 30 (G 51) 6" x 12" **mt**



DYNAMIC ARCH DARK
15 x 30 (G 51) 6" x 12" **mt**



PERFIL PROFILE

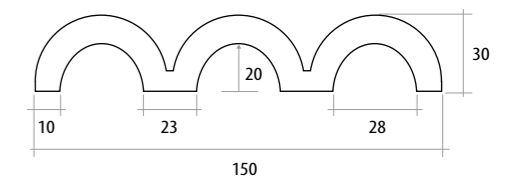

DYNAMIC ANGLE



DYNAMIC ANGLE FROST
12,5 x 30 (G 51) 5" x 12" **mt**



DYNAMIC ANGLE GRIZZLY
12,5 x 30 (G 51) 5" x 12" **mt**



DYNAMIC ANGLE DARK
12,5 x 30 (G 51) 5" x 12" **mt**



PERFIL PROFILE

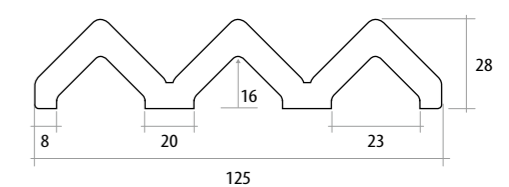

PACKING BASES

FORMATO	PULGADAS	PZ/CAJA	M ²	CAJA/PLT	PESO/CAJA	PESO/PLT
ARCH 15 x 30	6" x 12"	13	0,585	24	18,90	400

PACKING BASES

FORMATO	PULGADAS	PZ/CAJA	M ²	CAJA/PLT	PESO/CAJA	PESO/PLT
ANGLE 12,5 x 30	5" x 12"	20	0,75	24	23,1	570

www.natucer.es

PROYECTO: "REBIABLE"
Biorreactores de membrana sostenibles y competitivos para tratamientos

Objetivo: Promover el desarrollo tecnológico, la innovación y una investigación de calidad.



El proyecto, con nº de expediente RTC-2015-3485-5, ha sido cofinanciado por el Ministerio de Economía y Competitividad y el Fondo Europeo de Desarrollo regional (FEDER) en la convocatoria Retos-Colaboración del Programa Estatal de Investigación, Desarrollo e Innovación Orientada a los Retos de la Sociedad, en el marco del Plan Estatal de Investigación Científica y Técnica y de Innovación 2013-2016.

MADE IN SPAIN